

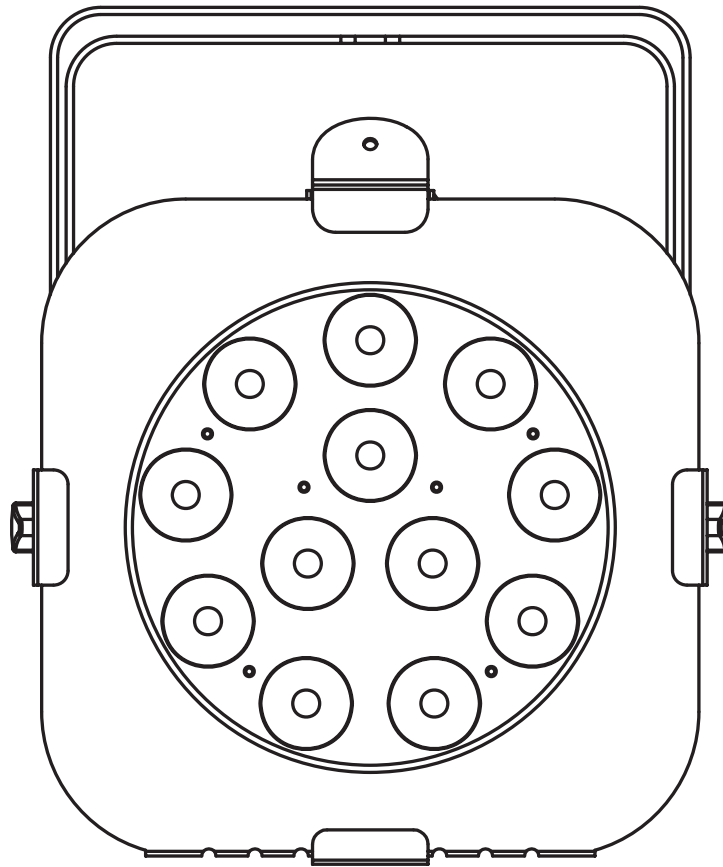

# 12PX HEX/12PX HEX PEARL



## *User Instructions*



©2018 ADJ Products, LLC all rights reserved. Information, specifications, diagrams, images, and instructions herein are subject to change without notice. ADJ Products, LLC logo and identifying product names and numbers herein are trademarks of ADJ Products, LLC. Copyright protection claimed includes all forms and matters of copyrightable materials and information now allowed by statutory or judicial law or hereinafter granted. Product names used in this document may be trademarks or registered trademarks of their respective companies and are hereby acknowledged. All non-ADJ Products, LLC brands and product names are trademarks or registered trademarks of their respective companies.

**ADJ Products, LLC** and all affiliated companies hereby disclaim any and all liabilities for property, equipment, building, and electrical damages, injuries to any persons, and direct or indirect economic loss associated with the use or reliance of any information contained within this document, and/or as a result of the improper, unsafe, insufficient and negligent assembly, installation, rigging, and operation of this product.

## DOCUMENT VERSION

Please check [www.adj.com](http://www.adj.com) for the latest revision/update of this guide.

Date	Document Version	Software Version $\geq$	DMX Channel Mode	Notes
6/17/18	1	1.10	6/7/8/12	Initial Release

Europe Energy Saving Notice

Energy Saving Matters (EuP 2009/125/EC)

Saving electric energy is a key to help protecting the environment. Please turn off all electrical products when they are not in use. To avoid power consumption in idle mode, disconnect all electrical equipment from power when not in use. Thank you!

Introduction	3
Features/Warranty Registration/Installation	4
Safety Precautions	5
Layout	7
DMX Set Up	8
DMX Addressing	10
DMX Channel Modes	11
Color Macro Chart	12
System Menu	14
Operating Instructions	15
Master-Slave Configuration	17
Dotz Par RF Operation	18
Dimmer Curve Chart	19
Dimensional Drawings	20
Power Linking/Trouble Shooting/Cleaning	21
Warranty	22
Specifications	23

**Unpacking:** Thank you for purchasing the 12PX Hex/12PX Hex Pearl by ADJ Products, LLC. Every 12PX Hex/12PX Hex Pearl has been thoroughly tested and has been shipped in perfect operating condition. Carefully check the shipping carton for damage that may have occurred during shipping. If the carton appears to be damaged, carefully inspect your fixture for any damage and be sure all accessories necessary to operate the unit has arrived intact. In the case damage has been found or parts are missing, please contact our toll free customer support number for further instructions. Do not return this unit to your dealer without first contacting customer support.

**Introduction:** The 12PX Hex/12PX Hex Pearl is a DMX intelligent, LED par fixture. This fixture can be used in a stand alone mode or connected in a Master/Slave configuration. This par has five operating modes: Sound Active mode, Program mode, RGBWA + UV dimmer mode, Static Color mode, and DMX control mode. The 12PX Hex/12PX Hex Pearl have 4 DMX channel modes; 6, 7, 8, & 12.

**Customer Support:** ADJ Products, LLC provides a customer support line, to provide set up help and to answer any question should you encounter problems during your set up or initial operation. You may also visit us on the web at [www.adj.com](http://www.adj.com) for any comments or suggestions. Service Hours are Monday through Friday 8:00 a.m. to 4:30 p.m. Pacific Standard Time.

Voice: (323) 582-2650  
Fax: (323) 582-2941  
E-mail: [support@americandj.com](mailto:support@americandj.com)

**Warning!** To prevent or reduce the risk of electrical shock or fire, do not expose this unit to rain or moisture.

**Caution!** There are no user serviceable parts inside this unit. Do not attempt any repairs yourself, doing so will void your manufactures warranty. In the unlikely event your unit may require service please contact ADJ Products, LLC.

***PLEASE recycle the shipping carton when ever possible.***

## 12PX Hex/12PX Hex Pearl

## Features

- Multi-Colors
- Five Operating Modes
- Electronic Dimming 0-100%
- 5 Dimmer Curves
- DMX-512 protocol
- 3-Pin & 5-Pin DMX Connection
- Four DMX Modes: 6 Channel Mode, 7 Channel Mode, 8 Channel Mode, and 12 Channel Mode.
- Dotz Par RF Compatible (Not Included)
- Multiple Unit Power Linking (See page 21)

Included:

1 x Power Cable

1 x Gel Frame Holder & Gel Frame

## 12PX Hex/12PX Hex Pearl

## Warranty Registration

The 12PX Hex and 12PX Hex Pearl carry a 2 year limited warranty. Please fill out the enclosed warranty card to validate your purchase. All returned service items whether under warranty or not, must be freight pre-paid and accompany a return authorization (R.A.) number. The R.A. number must be clearly written on the outside of the return package. A brief description of the problem as well as the R.A. number must also be written down on a piece of paper included in the shipping carton. If the unit is under warranty, you must provide a copy of your proof of purchase invoice. You may obtain a R.A. number by contacting our customer support team on our customer support number. All packages returned to the service department not displaying a R.A. number on the outside of the package will be returned to the shipper.

## 12PX Hex/12PX Hex Pearl

## Installation

The unit should be mounted using a mounting clamp (not provided), affixing it to the mounting bracket that is provided with the unit. Always ensure that the unit is firmly fixed to avoid vibration and slipping while operating. Always ensure that the structure to which you are attaching the unit is secure and is able to support a weight of 10 times the unit's weight. Also, always use a safety cable that can hold 12 times the weight of the unit when installing the fixture. The equipment must be installed by a professional, and it must be installed in a place where it is out of the reach of people's grasp.

- To reduce the risk of electrical shock or fire, do not expose this unit rain or moisture
- Do not spill water or other liquids into or on to your unit.
- Do not attempt to operate this unit if the power cord has been frayed or broken. Do not attempt to remove or break off the ground prong from the electrical cord. This prong is used to reduce the risk of electrical shock and fire in case of an internal short.
- Disconnect from main power before making any type of connection.
- Do not remove the cover under any conditions. There are no user serviceable parts inside.
- Never operate this unit when it's cover is removed.
- Never plug this unit in to a dimmer pack
- Always be sure to mount this unit in an area that will allow proper ventilation. Allow about 6" (15cm) between this device and a wall.
- Do not attempt to operate this unit, if it becomes damaged.
- This unit is intended for indoor use only, use of this product outdoors voids all warranties.
- During long periods of non-use, disconnect the unit's main power.
- Always mount this unit in safe and stable matter.
- Power-supply cords should be routed so that they are not likely to be walked on or pinched by items placed upon or against them, paying particular attention to the point they exit from the unit.
- Cleaning -The fixture should be cleaned only as recommended by the manufacturer. See page 21 for cleaning details.
- Heat -The appliance should be situated away from heat sources such as radiators, heat registers, stoves, or other appliances (including amplifiers) that produce heat.
- The fixture should be serviced by qualified service personnel when:
  - A. The power-supply cord or the plug has been damaged.
  - B. Objects have fallen, or liquid has been spilled into the fixture.
  - C. The fixture has been exposed to rain or water.
  - D. The fixture does not appear to operate normally or exhibits a marked change in performance.
  - E. The fixture has fallen and/or subjected to extreme handling.

**! CAUTION****HIGH  
INTENSITY  
ULTRAVIOLET  
LIGHT****AVOID DIRECT EYE & SKIN EXPOSURE.  
WEAR PROPER EYE & SKIN PROTECTION.  
SEE MANUAL FOR SAFETY INSTRUCTIONS.****RISK GROUP 3 - RISK OF EXPOSURE TO ULTRAVIOLET (UV) RADIATION!****FIXTURE EMITS HIGH INTENSITY ULTRAVIOLET (UV) LIGHT FROM THE UV LED.****WEAR PROPER EYE AND SKIN PROTECTION.****AVOID PROLONGED PERIODS OF EXPOSURE TO THE UV LED.****AVOID WEARING WHITE COLOR CLOTHING AND/OR USING (UV) PAINTS ON SKIN.****AVOID DIRECT EYE AND/OR SKIN EXPOSURE AT DISTANCES SHORTER THAN 11 feet (3.3m).****DO NOT OPERATE FIXTURE WITH DAMAGED OR MISSING EXTERNAL COVER.****DO NOT LOOK DIRECTLY INTO THE (UV) LIGHT AND/OR VIEW (UV) LIGHT DIRECTLY WITH OPTICAL INSTRUMENTS THAT MAY CONCENTRATE THE LIGHT/RADIATION OUTPUT.****INDIVIDUALS SUFFERING FROM A RANGE OF EYE CONDITIONS, SUNLIGHT EXPOSURE DISORDERS, OR INDIVIDUALS USING PHOTSENSITIVE MEDICATION, MAY RECEIVE DISCOMFORT IF EXPOSED TO THE ULTRAVIOLET (UV) LIGHT EMITTED FROM THIS FIXTURE.**

Power In Port  
Power Out Port  
3-Pin XLR Out Port  
3-Pin XLR In Port  
5-Pin XLR Out Port  
5-Pin XLR In Port

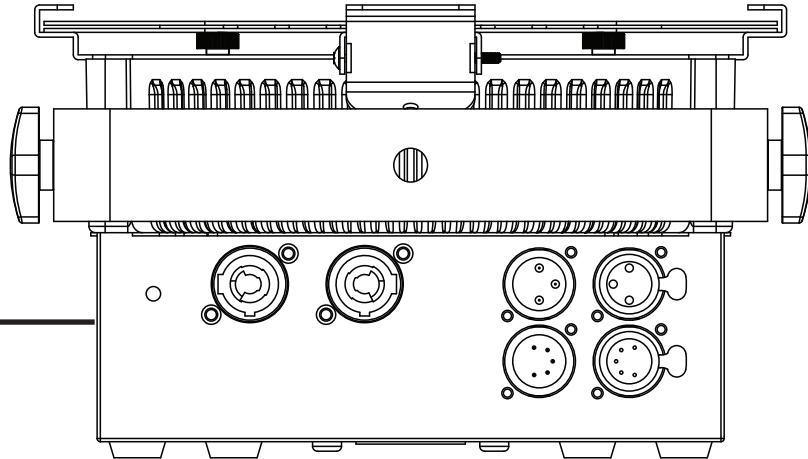

LCD Screen  
Mode Button  
Up Button  
Down Button  
Enter Button

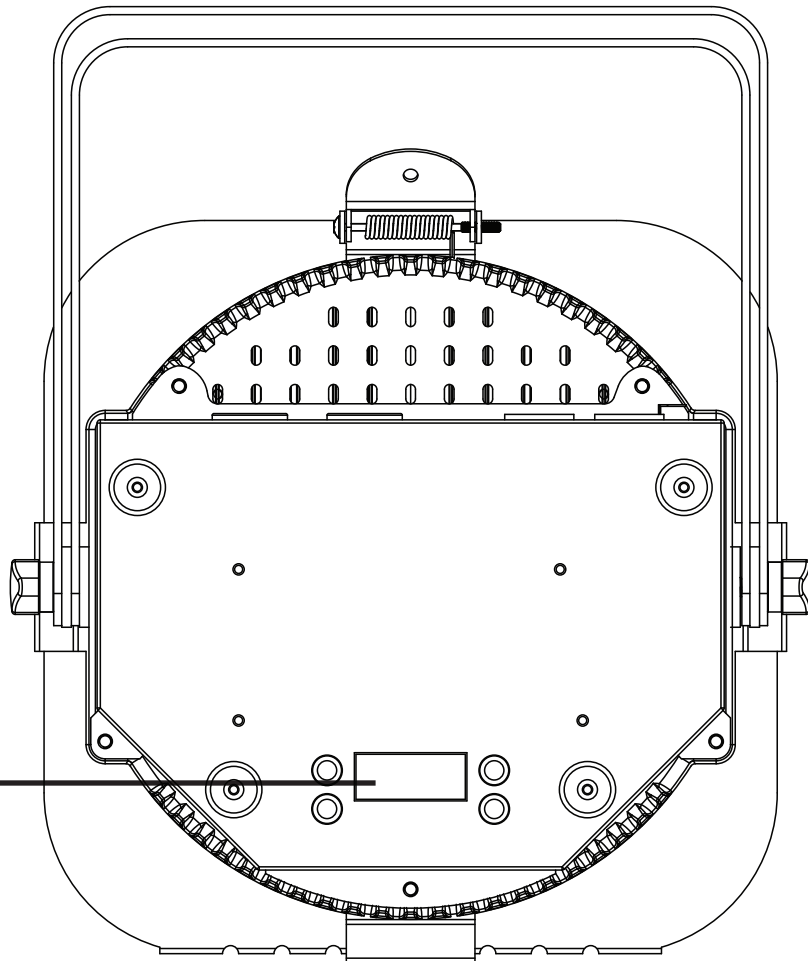



**DMX-512:** DMX is short for Digital Multiplex. This is a universal protocol used as a form of communication between intelligent fixtures and controllers. A DMX controller sends DMX data instructions from the controller to the fixture. DMX data is sent as serial data that travels from fixture to fixture via the DATA “IN” and DATA “OUT” XLR terminals located on all DMX fixtures (most controllers only have a DATA “OUT” terminal).

**DMX Linking:** DMX is a language allowing all makes and models of different manufactures to be linked together and operate from a single controller, as long as all fixtures and the controller are DMX compliant. To ensure proper DMX data transmission, when using several DMX fixtures try to use the shortest cable path possible. The order in which fixtures are connected in a DMX line does not influence the DMX addressing. For example; a fixture assigned a DMX address of 1 may be placed anywhere in a DMX line, at the beginning, at the end, or anywhere in the middle. When a fixture is assigned a DMX address of 1, the DMX controller knows to send DATA assigned to address 1 to that unit, no matter where it is located in the DMX chain.

**Data Cable (DMX Cable) Requirements (For DMX Operation):** The 12PX Hex and 12PX Hex Pearl can be controlled via DMX-512 protocol. The 12PX Hex/12PX Hex Pearl has 4 DMX channel modes. The DMX address is set on the back panel of the 12PX Hex/12PX Hex Pearl. Your unit and your DMX controller require a standard 3-pin or 5-pin XLR connector for data input and data output (Figure 1). We recommend Accu-Cable DMX cables. If you are making your own cables, be sure to use standard 110-120 Ohm shielded cable (This cable may be purchased at almost all pro lighting stores). Your cables should be made with a male and female XLR connector on either end of the cable. Also remember that DMX cable must be daisy chained and cannot be split.



Figure 1

**Notice:** Be sure to follow figures two and three when making your own cables. Do not use the ground lug on the XLR connector. Do not connect the cable’s shield conductor to the ground lug or allow the shield conductor to come in contact with the XLR’s outer casing. Grounding the shield could cause a short circuit and erratic behavior.

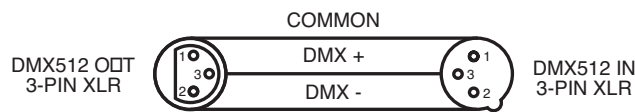

Figure 2

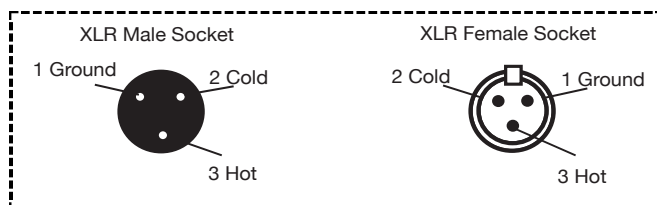

Figure 3

XLR Pin Configuration
Pin 1 = Ground
Pin 2 = Data Compliment (negative)
Pin 3 = Data True (positive)

**Special Note: Line Termination.** When longer runs of cable are used, you may need to use a terminator on the last unit to avoid erratic behavior. A terminator is a 110-120 ohm 1/4 watt resistor which is connected between pins 2 and 3 of a male XLR connector (DATA + and DATA -). This unit is inserted in the female XLR connector of the last unit in your daisy chain to terminate the line. Using a cable terminator (ADJ part number Z-DMX/T) will decrease the possibilities of erratic behavior.



Termination reduces signal errors and avoids signal transmission problems and interference. It is always advisable to connect a DMX terminal, (Resistance 120 Ohm 1/4 W) between PIN 2 (DMX-) and PIN 3 (DMX +) of the last fixture.

Figure 4

**5-Pin XLR DMX Connectors.** Some manufactures use 5-pin DMX-512 data cables for DATA transmission in place of 3-pin. 5-pin DMX fixtures may be implemented in a 3-pin DMX line. When inserting standard 5-pin data cables in to a 3-pin line a cable adaptor must be used, these adaptors are readily available at most electric stores. The chart below details a proper cable conversion.

3-Pin XLR to 5-Pin XLR Conversion		
Conductor	3-Pin XLR Female (Out)	5-Pin XLR Male (In)
Ground/Shield	Pin 1	Pin 1
Data Compliment (- signal)	Pin 2	Pin 2
Data True (+ signal)	Pin 3	Pin 3
Not Used		Do Not Use
Not Used		Do Not Use

All fixtures should be given a DMX starting address when using a DMX controller, so the correct fixture responds to the correct control signal. This digital starting address is the channel number from which the fixture starts to “listen” to the digital control signal sent out from the DMX controller. The assignment of this starting DMX address is achieved by setting the correct DMX address on the digital control display on the fixture.

You can set the same starting address for all fixtures or a group of fixtures, or set different addresses for each individual fixture. Setting all fixtures to the same DMX address will cause all fixtures to react in the same way, in other words, changing the settings of one channel will affect all the fixtures simultaneously.

If you set each fixture to a different DMX address, each unit will start to “listen” to the channel number you have set, based on the quantity of DMX channels of each fixture. That means changing the settings of one channel will only affect the selected fixture.

In the case of the 12PX Hex/12PX Hex Pearl, when in 12 channel mode you should set the starting DMX address of the first unit to 1, the second unit to 13 (12 + 1), the third unit to 25 (13 + 12), and so on. (See chart below for more details.)

Channel Mode	Unit 1 Address	Unit 2 Address	Unit 3 Address	Unit 4 Address
6 channels	1	7	13	19
7 channels	1	8	15	22
8 channels	1	9	17	25
12 channels	1	13	25	37

6CH	7CH	8CH	12CH		
1	1	1	1	0-255	<b>Red</b> 0~100%
2	2	2	2	0-255	<b>Green</b> 0~100%
3	3	3	3	0-255	<b>Blue</b> 0~100%
4	4	4	4	0-255	<b>White</b> 0~100%
5	5	5	5	0-255	<b>Amber</b> 0~100%
6	6	6	6	0-255	<b>UV</b> 0~100%
	7	7	7	0-255	<b>Master Dimmer</b> 0 ~100%
		8	8	0 - 31 32 - 63 64 - 95 96 - 127 128 - 159 160 - 191 192 - 223 224 - 255	<b>Strobe</b> LED Off LED On Strobe Slow - Fast LED On Strobe Pulse Slow - Fast LED On Random Strobe LED On
			9	0 - 255	<b>Color Macro</b> See pages 12-13 for the Color Macro Chart
			10	0 - 20 21 - 40 41 - 60 61 - 80 81 - 100 101 - 120 121 - 140 141 - 255	<b>Programs</b> No Function 30 Color Change 6 Color Change Color Fade Sound Active 30 Color Change Sound Active 6 Color Change Sound Active 6 Color Fade No Function
			11	0 - 255 0 - 255	<b>Program Speed/Sound Sensitivity</b> Slow - Fast Least Sensitive - Most Sensitive
			12	0 - 20 21-40 41-60 61-80 81-100 101-255	<b>Dimmer Modes</b> Standard Stage TV Architectural Theatre Default to unit setting

Color No.	DMX VALUE	RGBWA+UV COLOR INTENSITY					
		RED	GREEN	BLUE	WHITE	AMBER	UV
OFF	0	0	0	0	0	0	0
Color1	1-4	80	255	234	80	0	0
Color2	5-8	80	255	164	80	0	0
Color3	9-12	77	255	112	77	0	0
Color4	13-16	117	255	83	83	0	0
Color5	17-20	160	255	77	77	0	0
Color6	21-24	223	255	83	83	0	0
Color7	25-28	255	243	77	77	0	0
Color8	29-32	255	200	74	74	0	0
Color9	33-36	255	166	77	77	0	0
Color10	37-40	255	125	74	74	0	0
Color11	41-44	255	97	77	74	0	0
Color12	45-48	255	71	77	71	0	0
Color13	49-52	255	83	134	83	0	0
Color14	53-56	255	93	182	93	0	0
Color15	57-60	255	96	236	96	0	0
Color16	61-64	238	93	255	93	0	0
Color17	65-68	196	87	255	87	0	0
Color18	69-72	150	90	255	90	0	0
Color19	73-76	100	77	255	77	0	0
Color20	77-80	77	100	255	77	0	0
Color21	81-84	67	148	255	67	0	0
Color22	85-88	77	195	255	77	0	0
Color23	89-92	77	234	255	77	0	0
Color24	93-96	158	255	144	144	0	0
Color25	97-100	255	251	153	153	0	0
Color26	101-104	255	175	147	147	0	0
Color27	105-108	255	138	186	138	0	0
Color28	109-112	255	147	251	147	0	0
Color29	113-116	151	138	255	138	0	0
Color30	117-120	100	138	255	138	0	0
Color31	121-124	138	169	255	138	0	0
Color32	125-128	255	255	255	255	0	0

Color No.	DMX VALUE	RGBWA+UV COLOR INTENSITY					
		RED	GREEN	BLUE	WHITE	AMBER	UV
Color33	129-132	255	206	143	0	0	0
Color34	133-136	254	177	153	0	0	0
Color35	137-140	254	192	138	0	0	0
Color36	141-144	254	165	98	0	0	0
Color37	145-148	254	121	0	0	0	0
Color38	149-152	176	17	0	0	0	0
Color39	153-156	96	0	11	0	0	0
Color40	157-160	234	139	171	0	0	0
Color41	161-164	224	5	97	0	0	0
Color42	165-168	175	77	173	0	0	0
Color43	169-172	119	130	199	0	0	0
Color44	173-176	147	164	212	0	0	0
Color45	177-180	88	2	163	0	0	0
Color46	181-184	0	38	86	0	0	0
Color47	185-188	0	142	208	0	0	0
Color48	189-192	52	148	209	0	0	0
Color49	193-196	0	46	35	0	0	0
Color50	197-200	8	107	222	0	0	0
Color51	201-204	107	156	231	0	0	0
Color52	205-208	165	198	247	0	0	0
Color53	209-212	0	83	115	0	0	0
Color54	213-216	0	97	166	0	0	0
Color55	217-220	1	100	167	0	0	0
Color56	221-224	0	40	86	0	0	0
Color57	225-228	209	219	182	0	0	0
Color58	229-232	42	165	85	0	0	0
Color59	233-236	255	0	0	0	0	0
Color60	237-240	0	255	0	0	0	0
Color61	241-244	0	0	255	0	0	0
Color62	245-248	0	0	0	255	0	0
Color63	249-252	0	0	0	0	255	0
Color64	253-255	0	0	0	0	0	255

MENU	SUB MENU	OPTIONS/VALUES	DESCRIPTION
<b>Display Menu</b>	V110		
<b>Menu Function</b>	Set ADDR 001	A001-512	DMX Addressing
	Channel Mode	6/7/8/12	DMX Channel Modes
	Dimmer Curve	Standard (dC00) Stage (dC01) TV (dC02) Architec (dC03) Theatre (dC04)	Dimmer Curve Setting
	NODMX Hold	Hold /blc (Blackout)/Soun (Sound Active)	DMX Lost Setting
	Program Mode	P-01~07	Auto Run Programs
	Color Macros	C-00~63	Color Macro Mode
	Dimmer Mode	r : 000~255 g: 000~255 b: 000~255 u: 000~255 A: 000~255 U: 000~255	Dimmer Mode
	Sound Active	So00~30	Sound Active Mode
	Remote Activation	rFon or rFoF	Remote Sensor Activation
	Slave	SLAV	Slave Setting

**Control Panel Lock:**

The control panel will lock itself after 30 seconds if nothing is pressed. To unlock the control panel, press the MODE button for 3 seconds.

**Operating Modes:**

The 12PX Hex/12PX Hex Pearl has five operating modes:

- DMX control mode - This function will allow you to control each individual fixtures traits with a standard DMX 512 controller.
- RGBWA + UV Dimmer Mode - Choose one of the six colors to remain static or adjust the intensity of each color to make your own color.
- Sound Active mode - The unit will react to sound, chasing through the built in programs. The sound sensitivity is adjustable
- Program Mode - There are 7 built-in programs to choose from. Color change and color fade speeds are adjustable.
- Static Color Mode - There are 63 colors to choose from.

**RGBWA + UV Dimmer Mode:**

In this mode you can adjust the individual colors to make your desired color.

1. Plug the fixture in and press the MODE button until:
2. When “r.XXX” is displayed you are in Red dimming mode. Use the UP and DOWN buttons to adjust the intensity. After you have finished adjusting the intensity, or if you would like to skip to the next color, press the ENTER button.
3. When “GXXX” is displayed you are in Green dimming mode. Use the UP and DOWN buttons to adjust the intensity.
4. When “bXXX” is displayed you are in Blue dimming mode. Use the UP and DOWN buttons to adjust the intensity.
5. When “uXXX” is displayed you are in White dimming mode. Use the UP and DOWN buttons to adjust the intensity.
6. When “AXXX” is displayed you are in Amber dimming mode. Use the UP and DOWN buttons to adjust intensity.
7. When “UXXX” is displayed you are in UV dimming mode. Use the UP and DOWN buttons to adjust the intensity.

**Program Mode:**

In this mode you can choose 1 of 7 programs to run. The fade speed and program speed are both adjustable.

1. Plug the fixture in and press the MODE button until “P-XX” is displayed. “XX” is the current program number displayed.
2. Use the UP or DOWN button to find your desired program.
3. Press the ENTER button to adjust the fade speed, “00” being the slowest, “30” the fastest.
4. Press the ENTER button again to adjust the color change speed, “00” being the slowest, “30” the fastest.



**DMX Mode:**

Operating through a DMX controller gives the user the freedom to create their own programs tailored to their own individual needs. The 12PX Hex/12PX Hex Pearl have 4 DMX modes: 6 Channel mode, 7 Channel mode, 8 Channel mode, and a 12 Channel mode. See page 11 for each mode's DMX traits.

1. This function will allow you to control each individual fixture's traits with a standard DMX 512 controller.
2. To run your fixture in DMX mode press the MODE button until "AXXX" is displayed. "XXX" represents the current displayed address. Use the UP or DOWN buttons to select your desired DMX address, then press the ENTER button to select your DMX Channel mode.
3. Use the UP or DOWN buttons to scroll through the DMX Channel modes. The Channel modes are listed below:
  - To run the 6 Channel Mode, press the MODE button until "Ch06" is displayed. This is the 6 Channel DMX Mode.
  - To run the 7 Channel Mode, press the MODE button until "Ch07" is displayed. This is the 7 Channel DMX Mode.
  - To run the 8 Channel Mode, press the MODE button until "Ch08" is displayed. This is the 8 Channel DMX Mode.
  - To run the 12 Channel Mode, press the MODE button until "Ch12" is displayed. This is the 12 Channel DMX Mode.
4. Please see page 11 for DMX values and traits.
5. After you have chosen your desired DMX Channel mode plug in the fixture via the XLR connections to any standard DMX controller.

**Sound Active Mode:**

In this mode the 12PX Hex/12PX Hex Pearl will react to sound, and chase through the different colors.

1. Plug the fixture in and press the MODE button until "SoXX" is displayed. "XX" represents the sound sensitivity level. Use the UP and DOWN buttons to adjust the sensitivity. "00" is the lowest sensitivity, "30" is the highest.

**Static Color Mode:**

1. Plug the fixture in and press the MODE button until "C-XX" is displayed. "XX" is the color number currently displayed.
2. There are 63 colors to choose from. Use the UP and DOWN buttons to find your desired color.

**Dimmer Curve:**

This is used to set the dimmer curve used with DMX mode. See the Dimmer Curve chart on page 19 for more information.

1. Plug the fixture in and press the MODE button until the DMX address is displayed.
2. Press the ENTER button until "dCXX" is displayed. This is the dimmer setting. "XX" represents the current dimming mode.
3. Use the UP and DOWN buttons to find your desired dimmer curve. Press ENTER when you are finished.
  - dC00 - Standard
  - dC01 - Stage
  - dC02 - TV
  - dC03 - Architectural
  - dC04 - Theater

**Activate RF Control:**

This function is used to activate and deactivate the RF Remote Control. When this function is activated you can control the fixture using the Dotz Par RF remote. Please see the next page for remote controls and functions.

1. Plug the fixture in and press the MODE button until “rFXX” is displayed. “XX” represents either “on” or “oFF”.
2. Press the UP or DOWN buttons to either activate the remote function (On) or deactivate it (Off).

**DMX State:**

This mode is used as a precaution mode, that in case the DMX signal is lost, the operating mode chosen in this setup is the running mode the fixture will go into when the DMX signal is lost. You can also set this as the operating mode you would like the unit to return to when power is applied.

1. Press the MODE button until the DMX address is displayed. Press the ENTER button until either “Soun”, “HOLd”, or “blC” is displayed.
  2. Use the UP or DOWN buttons to find the mode you want incase of power loss or DMX loss.
- “blC” (Blackout) - If the DMX signal is lost or interrupted, the unit will automatically go into stand by mode.
  - “HOLd” (Last State) - If the DMX signal is lost or interrupted, the fixture will stay in the last DMX set up. If power is applied and this mode is set, the unit will automatically go into the last DMX set up.
  - “Soun” (Sound Active) - If the DMX signal is lost or interrupted, the unit will automatically go into sound active mode.
3. Find your desired setting and press ENTER. Your setting will be saved automatically.

**Master-Slave Configuration:**

This function will allow you to link units together to run in a Master-Slave mode. In Master-Slave operation one unit will act as the controlling unit and the others will react to the controlling units built-in programs. Any unit can act as a Master or as a Slave however, only one unit can be programmed to act as the “Master.”

**Master-Slave Connections and Settings:**

1. Daisy chain your units via the XLR connector on the rear of the unit. Use standard XLR data cables to link your units together. Remember that the Male XLR connector is the input and the Female XLR connector is the output. The first unit in the chain (master) will use the female XLR connector only. The last unit in the chain will use the male XLR connector only.
2. Set the “Master” unit to your desired mode of operation.
3. Connect the first “Slave” unit to the “Master.”
4. On the “Slave” unit press the MODE button until “SLAV” is displayed. The “Slave” unit will now follow the “Master”.

The Dotz Par RF remote (sold separately) has many different functions and allows you to control your fixture from long distance. The remote can control your system up to 25 meters. To use the remote you must first activate the fixtures receiver, to activate the receiver please see the instructions on page 17.

**BLACKOUT** - Pressing this button will blackout the fixture.

**FADE** - This button will activate the fade program.

**COLOR** - This button will activate the static color mode. Use the “+” and “-” buttons to scroll through the colors and find your desired color.

**PROGRAMS** - This button will activate the built-in programs mode. Use the “+” and “-” buttons to scroll through the 7 programs and find your desired program.

**SOUND ACTIVE** - This button activates sound active mode.

**AUTO RUN** - When in program mode, press this button and use the “+” and “-” buttons to adjust the speed of the built-in programs. You can also use this button to activate program mode.

**“+” and “-”** - Use these buttons to adjust the speed of the built-in program, scroll through the built-in programs, and scroll through the static colors.

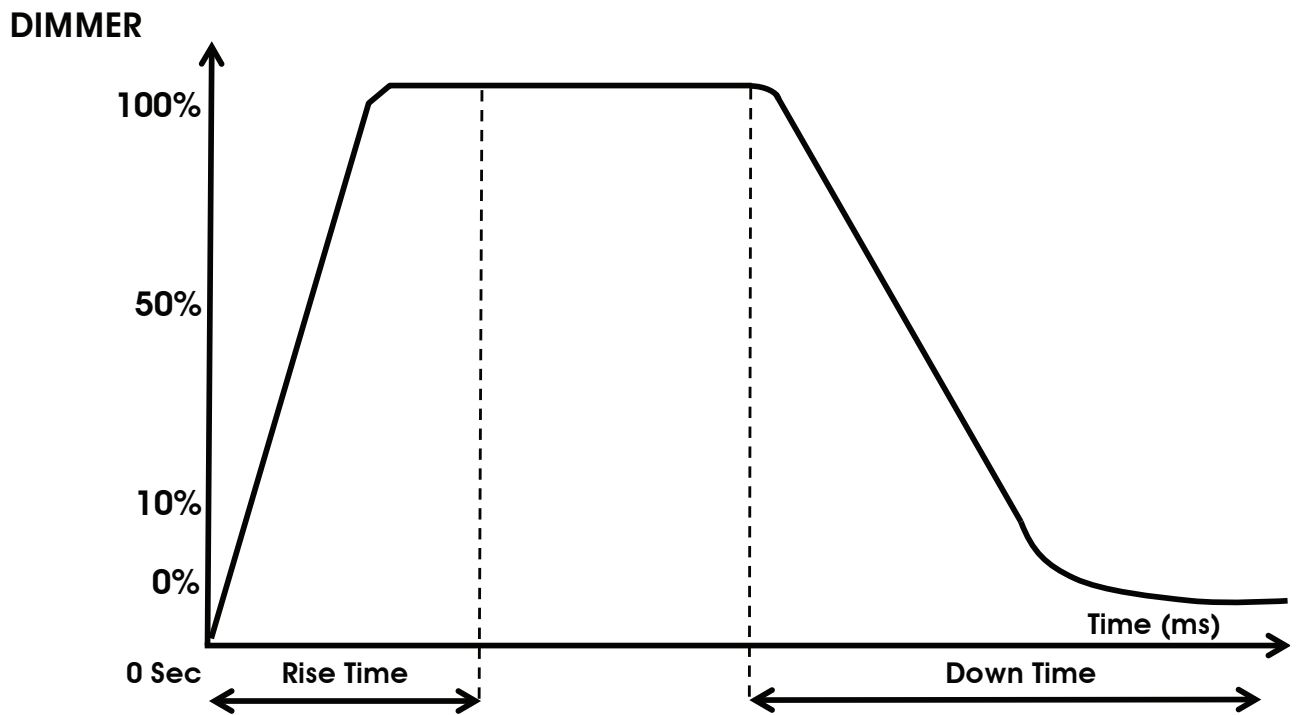

Dimming Curve Ramp Effect	0 sec Fade Time		1 sec Fade Time	
	Rise Time (ms)	Down Time (ms)	Rise Time (ms)	Down Time (ms)
Standard (default)	0	0	0	0
Stage	780	1100	1540	1660
TV	1180	1520	1860	1940
Architectural	1380	1730	2040	2120
Theatre	1580	1940	2230	2280

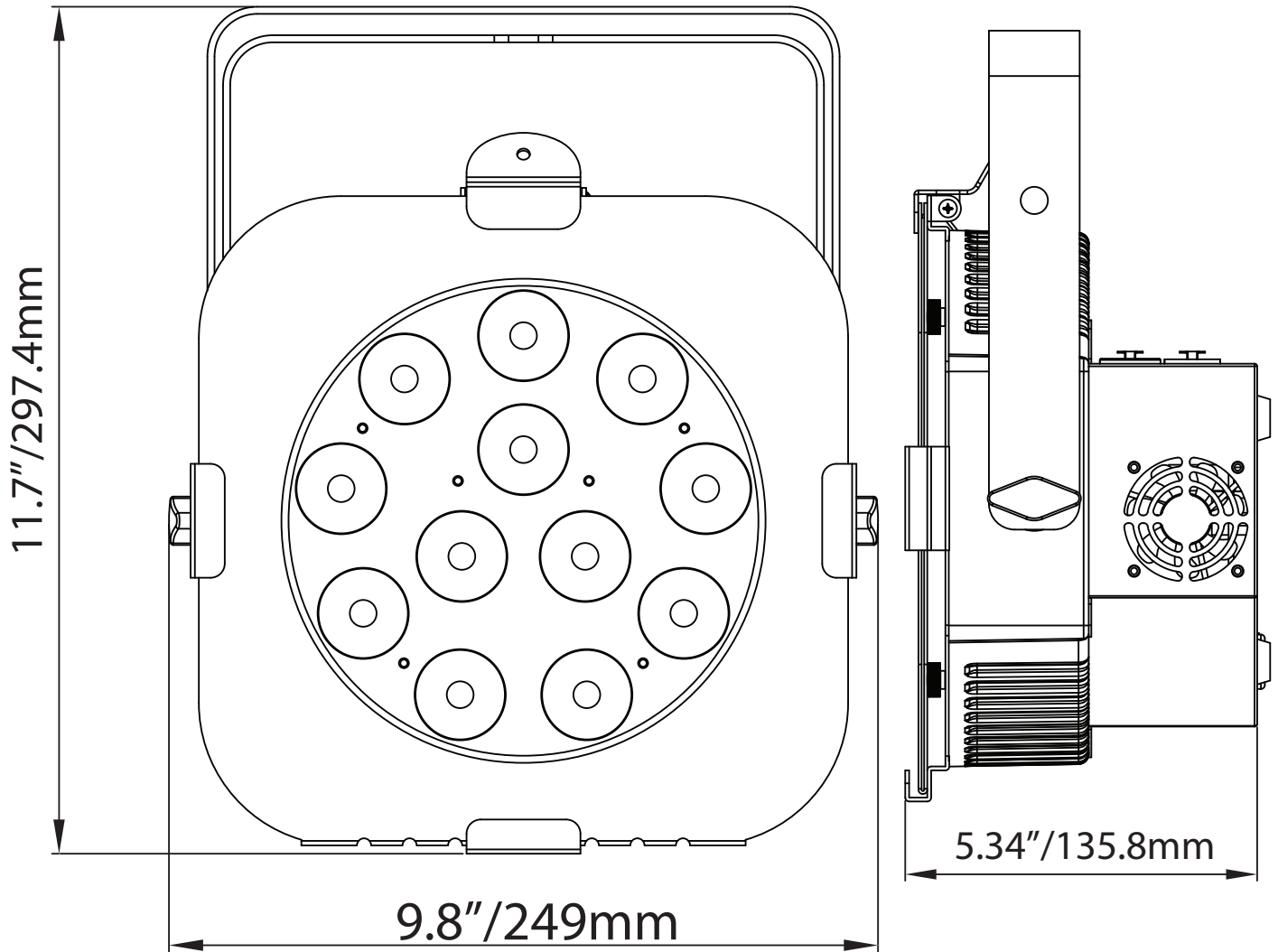

## 12PX Hex/12PX Hex Pearl

## Multiple Unit Power Linking

With this feature you can connect the fixtures to one another using the power cable input and output sockets.

**NOTE: USE CAUTION WHEN POWER LINKING OTHER FIXTURES AS THE POWER CONSUMPTION OF OTHER MODEL FIXTURES MAY EXCEED THE MAX POWER OUTPUT ON THIS FIXTURE! CHECK SILK SCREEN FOR MAX AMPS.**

## 12PX Hex/12PX Hex Pearl

## Trouble Shooting

Listed below are a few common problems the user may encounter, with solutions.

### ***Unit not responding to DMX:***

1. Check that the DMX cables are connected properly and are wired correctly (pin 3 is “hot”; on some other DMX devices pin 2 may be ‘hot’). Also, check that all cables are connected to the right connectors; it does matter which way the inputs and outputs are connected.

### ***Unit does not respond to sound:***

1. Quiet or high pitched sounds will not activate the unit.
2. Make sure that Sound Active mode is activated.

## 12PX Hex/12PX Hex Pearl

## Cleaning

Due to fog residue, smoke, and dust cleaning the internal and external optical lenses must be carried out periodically to optimize light output.

1. Use normal glass cleaner and a soft cloth to wipe down the outside casing.
2. Clean the external optics with glass cleaner and a soft cloth every 20 days.
3. Always be sure to dry all parts completely before plugging the unit back in.

Cleaning frequency depends on the environment in which the fixture operates (i.e. smoke, fog residue, dust, dew).

**MANUFACTURER'S LIMITED WARRANTY**

- A. ADJ Products, LLC hereby warrants, to the original purchaser, ADJ Products, LLC products to be free of manufacturing defects in material and workmanship for a prescribed period from the date of purchase (see specific warranty period on reverse). This warranty shall be valid only if the product is purchased within the United States of America, including possessions and territories. It is the owner's responsibility to establish the date and place of purchase by acceptable evidence, at the time service is sought.
- B. For warranty service you must obtain a Return Authorization number (RA#) before sending back the product—please contact ADJ Products, LLC Service Department at 800-322-6337. Send the product only to the ADJ Products, LLC factory. All shipping charges must be pre-paid. If the requested repairs or service (including parts replacement) are within the terms of this warranty, ADJ Products, LLC will pay return shipping charges only to a designated point within the United States. If the entire instrument is sent, it must be shipped in its original package. No accessories should be shipped with the product. If any accessories are shipped with the product, ADJ Products, LLC shall have no liability whatsoever for loss of or damage to any such accessories, nor for the safe return thereof.
- C. This warranty is void if the serial number has been altered or removed; if the product is modified in any manner which ADJ Products, LLC concludes, after inspection, affects the reliability of the product; if the product has been repaired or serviced by anyone other than the ADJ Products, LLC factory unless prior written authorization was issued to purchaser by ADJ Products, LLC; if the product is damaged because not properly maintained as set forth in the instruction manual.
- D. This is not a service contract, and this warranty does not include maintenance, cleaning or periodic check up. During the period specified above, ADJ Products, LLC will replace defective parts at its expense with new or refurbished parts, and will absorb all expenses for warranty service and repair labor by reason of defects in material or workmanship. The sole responsibility of ADJ Products, LLC under this warranty shall be limited to the repair of the product, or replacement thereof, including parts, at the sole discretion of ADJ Products, LLC. All products covered by this warranty were manufactured after August 15, 2012, and bear identifying marks to that effect.
- E. ADJ Products, LLC reserves the right to make changes in design and/or improvements upon its products without any obligation to include these changes in any products theretofore manufactured.

No warranty, whether expressed or implied, is given or made with respect to any accessory supplied with products described above. Except to the extent prohibited by applicable law, all implied warranties made by ADJ Products, LLC in connection with this product, including warranties of merchantability or fitness, are limited in duration to the warranty period set forth above. And no warranties, whether expressed or implied, including warranties of merchantability or fitness, shall apply to this product after said period has expired. The consumer's and/or Dealer's sole remedy shall be such repair or replacement as is expressly provided above; and under no circumstances shall ADJ Products, LLC be liable for any loss or damage, direct or consequential, arising out of the use of, or inability to use, this product.

This warranty is the only written warranty applicable to ADJ Products, LLC Products and supersedes all prior warranties and written descriptions of warranty terms and conditions heretofore published.

**MANUFACTURER'S LIMITED WARRANTY PERIODS:**

- **Non L.E.D. Lighting Products = 1-year (365 days) Limited Warranty** (Such as: Special Effect Lighting, Intelligent Lighting, UV lighting, Strobes, Fog Machines, Bubble Machines, Mirror Balls, Par Cans, Trussing, Lighting Stands etc. excluding LED and lamps)
- **Laser Products = 1 Year (365 Days) Limited Warranty** (excluding laser diodes which have a 6 month limited warranty)
- **L.E.D. Products = 2-year (730 days) Limited Warranty** (excluding batteries which have a 180 day limited warranty). **Note: 2 Year Warranty only applies to purchases within the United States.**
- **StarTec Series = 1 Year Limited Warranty** (excluding batteries which have a 180 day limited warranty).
- **ADJ DMX Controllers = 2 Year (730 Days) Limited Warranty**

**Model: 12PX Hex/12PX Hex Pearl**

Voltage:	100V ~ 240V/50~60Hz
LEDs:	12 x 12W 6-in-1 HEX LED's
Working Position:	Any safe working position
Power Draw:	133W
Weight:	8.7 lbs./ 4 Kgs.
Dimensions:	5.34" (L) x 9.8" (W) x 11.7" (H) 135.8 x 249 x 297.4mm
Colors:	RGBWA+UV Color Mixing
DMX Channels:	4 DMX Modes: 6 Channel Mode, 7 Channel Mode, 8 Channel Mode & 12 Channel Mode
Warranty:	2 Year (730 days)

**Please Note:** Specifications and improvements in the design of this unit and this manual are subject to change without any prior written notice.

**FCC STATEMENT**

This device complies with Part 15 of the FCC Rules. Operation is subject to the following two conditions: (1) this device may not cause harmful interference, and (2) this device must accept any interference received, including interference that may cause undesired operation.

**FCC RADIO FREQUENCY INTERFERENCE WARNINGS & INSTRUCTIONS**

This product has been tested and found to comply with the limits as per Part 15 of the FCC Rules. These limits are designed to provide reasonable protection against harmful interference in a residential installation. This device uses and can radiate radio frequency energy and, if not installed and used in accordance with the included instructions, may cause harmful interference to radio communications. However, there is no guarantee that interference will not occur in a particular installation. If this device does cause harmful interference to radio or television reception, which can be determined by turning the device off and on, the user is encouraged to try to correct the interference by one or more of the following methods:

- Reorient or relocate the device.
- Increase the separation between the device and the receiver.
- Connect the device to an electrical outlet on a circuit different from which the radio receiver is connected.
- Consult the dealer or an experienced radio/TV technician for help.

ADJ Products, LLC  
6122 S. Eastern Ave. Los Angeles, CA 90040 USA  
Tel: 323-582-2650 / Fax: 323-582-2941  
www.adj.com / info@americandj.com

**Follow Us On:**

facebook.com/americandj  
twitter.com/americandj  
youtube.com/adjlighting

A.D.J. Supply Europe B.V.  
Junostraat 2  
6468 EW Kerkrade  
The Netherlands  
www.adj.eu / support@adjgroup.eu  
Tel: +31 45 546 85 00 / Fax: +31 45 546 85 99