

ArenaMatch Utility AMU208

small-format foreground/fill loudspeaker

Product Overview

Built for zone-fill coverage or high-SPL foreground music, Bose ArenaMatch Utility loudspeakers feature similar tonal balance to ArenaMatch Utility loudspeakers but in compact designs. They have the same EMB2S compression driver as ArenaMatch arrays, ensuring consistent sound, and the same IP55 weather rating. Deploy them for zone-fill coverage in sports stadiums, arenas, outdoor entertainment centers, and more. Or use them to provide intelligible, high-level sound in any outdoor area — from niche venues such as breweries and fairgrounds to larger settings like resorts and outdoor shopping centers.

The AMU208 is a small-format ArenaMatch Utility model for outdoor applications that require excellent audio from a compact loudspeaker. It provides wide, even coverage with a 90° x 60° constant-directivity high-frequency horn, 70 Hz – 18 kHz frequency response, 126 dB peak SPL, and supports the lowest vocal ranges with two Bose LF8 8-inch woofers.



Key Features

Deploy as zone-fill to support ArenaMatch arrays systems, delivering powerful, intelligible sound and ensuring consistent tonal balance with EMB2S compression drivers in every speaker

Deploy to provide high-level foreground music in any outdoor venue

Install outdoors with an IP55 weather rating, three-layer stainless steel grille, water-resistant woofer cone coating, industrial polyurethane exterior coating, and molded cover to protect inputs

Adapt to a variety of configurations — all models ship standard with 70/100V transformer inputs and passive crossover with optimized filters for more consistent frequency and polar response

Streamline the design process by combining with complementary Bose Professional products, such as PowerMatch amplifiers and ControlSpace DSPs

Mount easily with included stainless-steel U-bracket; rear enclosure panel also includes M8 threaded inserts to accept third-party accessory mounting brackets

Provide wide, even coverage with 90° x 60° constant-directivity high-frequency horn, which can be rotated for horizontal or vertical installation

Perform in the most demanding applications with 70 Hz – 18 kHz frequency response and 126 dB maximum peak SPL

Support lowest vocal range with 2x Bose LF8 8-inch woofers featuring a 2-inch extended-excursion voice coil, which extends response to 70 Hz

ArenaMatch Utility AMU208

small-format foreground/fill loudspeaker

Technical Specifications

Single Module Performance				
Frequency Response (-3 dB) ¹	80 Hz to 16 kHz			
Frequency Range (-10 dB)	70 Hz to 18 kHz			
Nominal Coverage Pattern (H × V)	90° × 60° (rotatable high-frequency horn)			
Recommended High-pass Filter	70 Hz with minimum 12-dB / octave filter			
Crossover	passive; separate bandpass filters per transducer (200 Hz and 1.2 kHz)			
70/100V transformer tap settings	70V: 5, 10, 20, 40, 80 W; 100V: 10, 20, 40, 80 W			
	Bose Extended Lifecycle Test ²		AES Transducer Test ³	
Power Handling, long-term continuous	300 W		400 W	
Power Handling, peak	1200 W		1600 W	
	Free field	Wall/Ceiling	Free field	Wall/Ceiling
Sensitivity (SPL / 1W @ 1 m) ⁴	95 dB	97 dB	95 dB	97 dB
Calculated Maximum SPL @ 1 m ⁵	120 dB	122 dB	121 dB	123 dB
Calculated Maximum SPL @ 1 m, peak	126 dB	128 dB	127 dB	129 dB
Transducers				
Low Frequency	2 x Bose LF8 high-excursion 8-inch woofers (2-inch voice coil)			
High Frequency	1 x Bose EMB2S extended high-frequency compression driver (2-inch voice coil)			
Nominal Impedance	8 Ω			
Physical				
Enclosure Material	Exterior-grade plywood			
Finish	Two-part spray polyurea coating, black or white			
Grille	3-layer: perforated stainless steel, acoustic foam, stainless steel mesh, powder-coat finish			
Environmental	IEC 60529 IP55 for outdoor, direct-exposure installations			
Connectors	1x barrier strip, (accepts 10 to 18 wire gauge)			
Suspension/Mounting	2x M8 threaded inserts for U-bracket; 4x M8 threaded inserts on rear (127 × 70 mm, 4-bolt pattern)			
Dimensions (H × W × D)	235 × 686 × 279 mm (9.3 × 27.0 × 11.0 in) with input cover			
Net Weight	17.0 kg (37.5 lb) / 19.5 kg (43.0 lb) with u-bracket			
Shipping Weight	23.1 kg (51.0 lb)			
Accessories	optional pan-and-tilt bracket			
Product Code				
Black	811436-0110			
White	811436-0210			

Footnotes

- (1) Frequency response and range measured on-axis in anechoic environment with recommended bandpass and EQ.
 (2) Bose extended-lifecycle test using pink noise filtered to meet IEC268-5, 6-dB crest factor, 500-hour duration.
 (3) AES standard 2-hour duration with IEC system noise.
 (4) Sensitivity measured in anechoic environment with recommended bandpass and EQ.
 (5) Maximum SPL calculated using sensitivity and power ratings, exclusive of power compression.

ArenaMatch Utility AMU208

small-format foreground/fill loudspeaker

Frequency Response

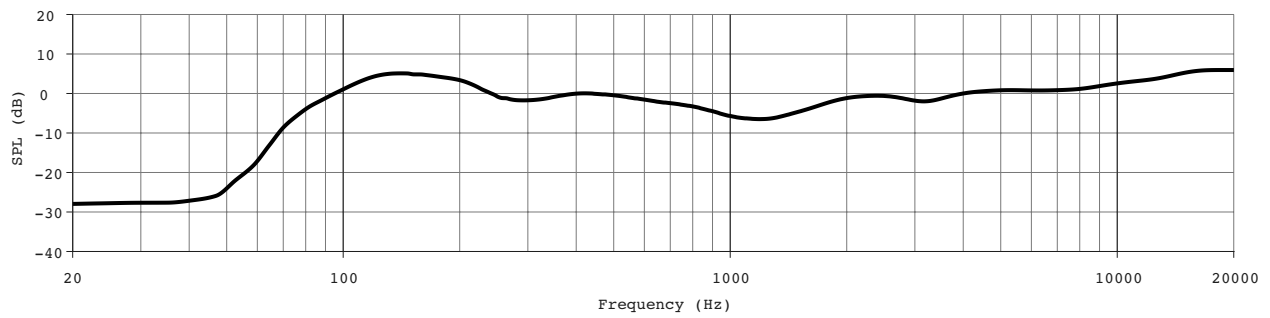

Beamwidth

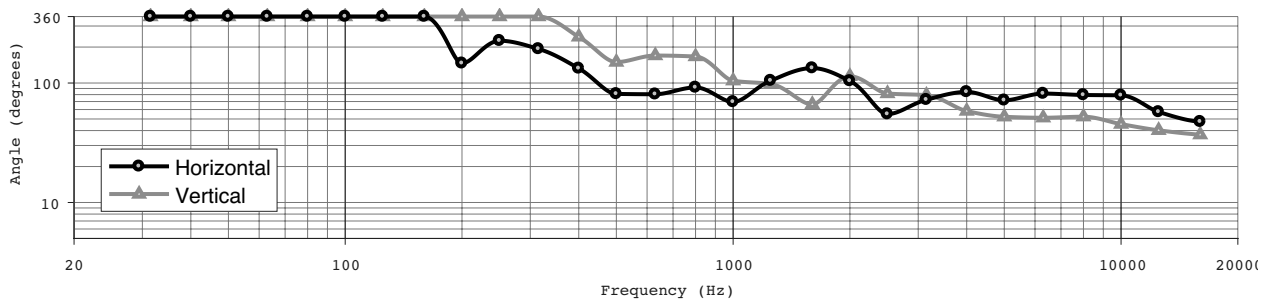

ArenaMatch Utility AMU208

small-format foreground/fill loudspeaker

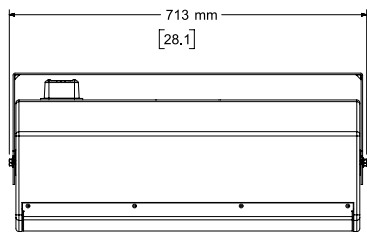

Top View

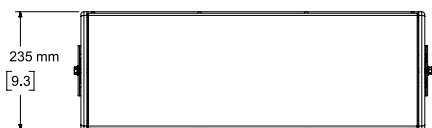

Front View

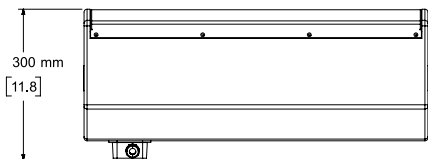

Bottom View
BRACKET REMOVED FOR CLARITY

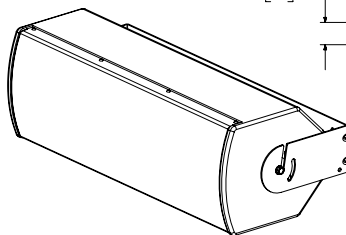

Right View
DIMENSIONS APPLY TO BOTH SIDES

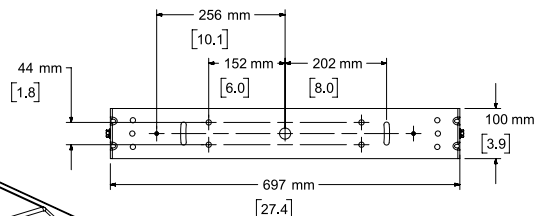

Rear View
BRACKET ONLY

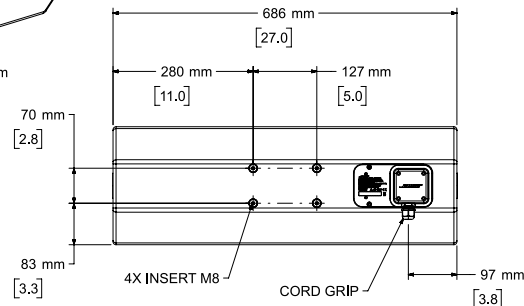

Rear View
BRACKET REMOVED FOR CLARITY

- NOTES:
 1. DIMENSIONS ARE IN MILLIMETERS OVER INCHES
 2. WEIGHT APPROX 17.0kg [37.5lbs] (SPEAKER ONLY)
 WEIGHT W/BRACKET 19.5kg [43.0lbs]