

CS-620FH/630FH/680FH series speaker is the speaker for playing music using coaxial 2 way driver. It is the finest solution for the space such as class room, meeting room which needs High-quality sound and high intelligibility.



FEATURES

- **6.5" coaxial 2Way speaker**
- **Using High-quality matching transformer (100V)**
- **Low impedance input terminal**
Provides a connection terminal for low impedance (8 ohm) to play high-quality music.
- **Suitable for music playing**
It is suitable for playing music with a wide band bandwidth ranging from 400Hz~4kHz.
- **Offering an installation bracket**
It ensures an safe installation of speaker by providing High-quality speaker installation tools made up with bracket-ring and bracket-rail.

● Tap switch

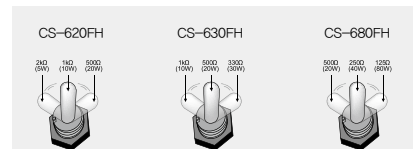

● Connecting the each output cable of speaker

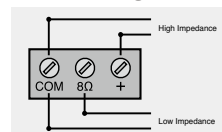

SPECIFICATION

Model		CS-620FH	CS-630FH	CS-680FH
Type	6.5" 2Way Coaxial Ceiling Speaker			
Unit	LF : 6.5", HF : 1"			
Power Handling(AES)	20W		30W	80W
Input Power	100V	20/10/5W	30/20/10W	80/40/20W
	70V		-	
Impedance	100V	500/1k/2kΩ	330/500/1kΩ	125/250/500Ω
	70V		-	
	LOW		8Ω	
Power Selection	Toggle Switch			
Frequency Response (-10dB)	200Hz ~ 20kHz			
Sensitivity (1W/1m 300,400,500,600Hz avg.)	88dB	90dB	88dB	
Maximum SPL[Cont]	101dB	105dB	107dB	
Norminal Dispersion	130°	70°	130°	
Input Connector	3P Euroblock			
Enclosure Material	ABS(V0)			
Enclosure Color(Front)	Light Gray			
Grill Material	Metal Grill			
Grill Color	Light Gray			
Cut-Out Diameter(Ø, mm)	Ø200~205			
Weight (Net)	2kg	2.42kg	3.57kg	
Dimensions (Ø(WxH) x D, mm)	Ø230 x 168			
Weather Resistant	IP34			
Flame resistant	O			
Certification	-			
Included Accessories	-			

CS-620FH/630FH/680FH

Ceiling
Speaker

TECHNICAL DATA

DIMENSION

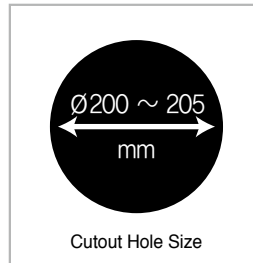
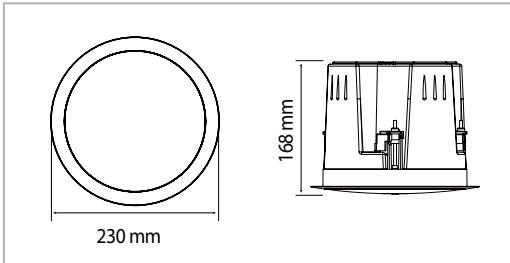

FREQUENCY RANGE

• CS-620FH

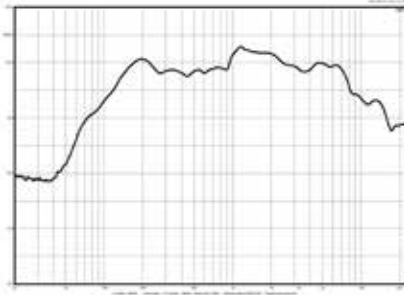

• CS-630FH

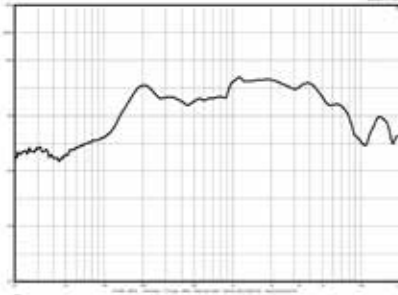

• CS-680FH

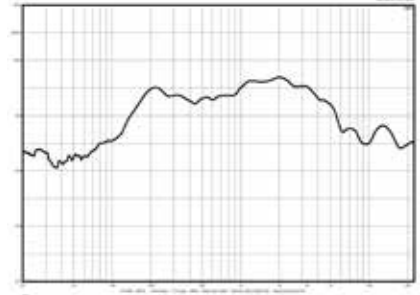

POLAR PATTERN

• CS-620FH

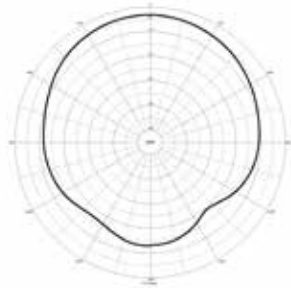

• CS-630FH

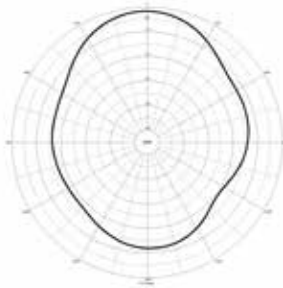

• CS-680FH

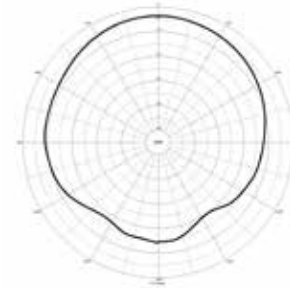

SPEAKER INSTALLATION GUIDE

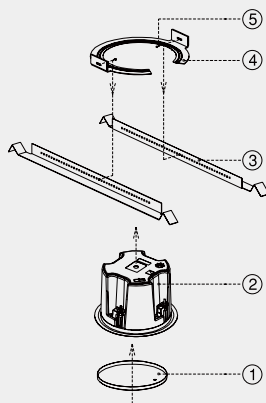

5	SCREW 1WPTC 4 x 12B	2
4	BKT-RING	1
3	BKT-RAIL	2
2	SET	1
1	GRILL COVER	1
NO	NAME	QTY

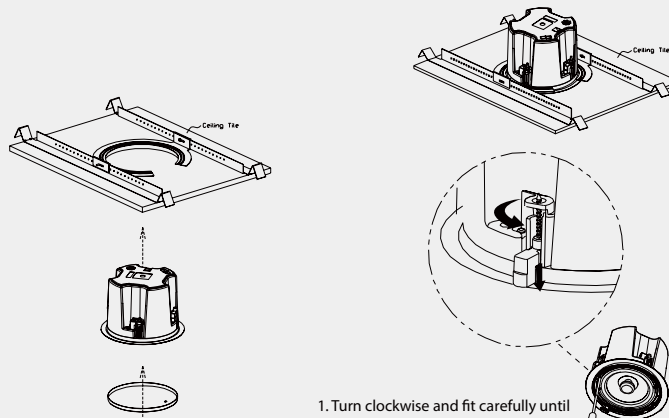

※ Ceiling Hole Size : $\varnothing 200 \sim \varnothing 205$

1. Turn clockwise and fit carefully until approaching ceiling or BKT-RING.
2. Put GRILL-COVER on the hall of SET and press to be combined.