

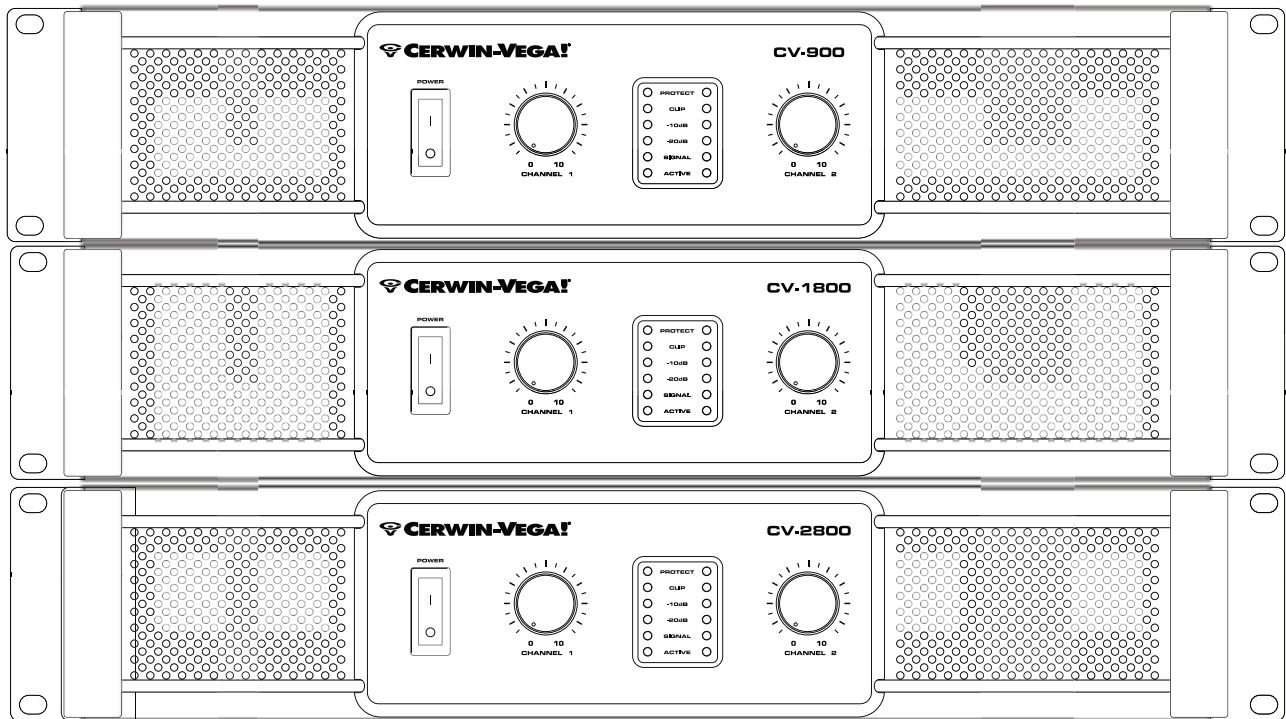



# CV-900 / CV-1800 / CV-2800 HEAVY DUTY PROFESSIONAL AMPLIFIERS



## USER MANUAL

# IMPORTANT SAFETY INSTRUCTIONS

1. Read Instructions – All the safety and operating instructions should be read before this product is operated.
2. Retain Instructions – The safety and operating instructions should be retained for future reference.
3. Heed Warnings – All warnings on the appliance and in the operating instructions should be adhered to.
4. Follow Instructions – All operating and use instructions should be followed.
5. Do not use this amplifier near water. The amplifier should not be used near water or moisture or dripping or splashing — for example, in a wet basement, in the rain, or near a swimming pool. Objects that contain liquids, such as vases, shall not be placed on the amplifier.
6. Clean only with dry cloth.
7. Do not block any ventilation openings. Please install in a well ventilated environment.
8. Do not install near any heat sources such as radiators, heat registers, stoves, or other apparatus (including amplifiers) that produce heat.
9. Do not defeat the safety purpose of the polarized or grounding plug. A polarized plug has two blades with one wider than the other. A grounding plug has two blades and third prong. The wide blade or the third prong is provided for safety. If the provided plug does not fit into your outlet, consult an electrician for replacement of the obsolete outlet.
10. **WARNING:** The mains plug or amplifier power inlet is used as a disconnect device, the disconnect device shall remain readily operable. Protect the power cord from being walked on or pinched particularly at the plugs, convenience receptacles, and at the point where they exit from the amplifier.
11. Use only attachments/accessories specified by the manufacturer.
12. Use this amplifier only with carts and rack equipment rated for this type of equipment. When a cart or rack is used use caution when moving to avoid injury from a tip-over. 
13. Unplug the amplifier during lightning storms or when unused for long periods of time.
14. Refer all servicing to qualified personnel. Servicing is required when the amplifier has been damaged in any way, such as the power cord is damaged, objects have fallen into the amplifier, the amplifier has been exposed to rain or moisture, has been dropped or does not operate normally.
15. This amplifier should only be operated from the type of power source indicated on the rating label. If you are not sure of the type of power coming from your wall socket, consult your product dealer or local power company.
16. **WARNING:** to prevent hazardous electrical shock do not touch the conductive parts of the output terminals. The external wiring connected to these terminals requires installation by a qualified technician.
17. This product is in compliance with EU WEEE regulations. Disposal of end of life of product should not be treated as municipal waste. Please refer to your local regulations for instructions on proper disposal of this product. 



Caution Hot Surface! Heat danger. Please don't touch the area because a high temperature danger may exist. Use caution when touching surfaces marked with this logo as they may become hot during extend use.



"Protective earthing terminal. The amplifier should be connected to a mains socket outlet with a protective grounding connection terminal. The amplifier should be connected to a mains socket outlet with a proper grounding connection for safe operation.



This lightning flash is intended to alert the user to the presence of non-insulated "dangerous voltage" on the output terminals that may be of sufficient magnitude to constitute a risk of electric shock. The external wiring connected to the terminals requires installation by an instructed person or the used of ready-made leads or cords. of



**CAUTION**  
RISK OF ELECTRIC SHOCK  
DO NOT OPEN



**CAUTION:** To reduce the risk of electric shock, do not remove any cover. No user-serviceable parts inside. Refer servicing to qualified service personnel only.



The lightning flash with arrowhead symbol within the equilateral triangle is intended to alert the user to the presence of un-insulated "dangerous voltage" within the product's enclosure that may be of sufficient magnitude to constitute a risk of electric shock.



The exclamation point within the equilateral triangle is intended to alert the user to the presence of important operation and maintenance (servicing) instructions in the literature accompanying this appliance.

**CAUTION:** To prevent electric shock, do not use this polarized plug with an extension cord, receptacle or other outlet unless the blades can be fully inserted to prevent blade exposure.

## INTRODUCTION

Thank you for your decision to purchase Cerwin-vega's innovative new CV Series professional power amplifier! Engineered for superior sound reproduction, the CV Series line of professional amplifiers deliver top quality audio at an affordable price. The CV Series offer a standard of reliability and efficiency that makes them the perfect solution for every DJ, musician, and sound engineer. Welcome to a new level of professional quality sound performance!

## UNPACKING & INSTALLATION

Although it is neither complicated to install, nor difficult to operate your amplifier, a few minutes of your time are required to read this manual for a properly wired installation, and to become familiar with the unit's features. Please take great care in unpacking the unit and do not discard the carton and other packing materials. They may be needed when moving the unit and are required if it ever becomes necessary to return the unit for service. Never place the unit near a radiator, in front of heating vents, in direct sunlight, in excessive humidity, or dusty locations to avoid damages and to guaranty a long reliable use. Connect the unit with the system components according to the description on the following pages.

## FEATURES

- Cerwin-vega amplifiers deliver the following power ratings.
  - CV-900 - 2 x 210 Watts at 8 ohm, 2 x 320 Watts at 4 ohm and 2 x 420 Watts at 2 ohm
  - CV-1800 - 2 x 400 Watts at 8 ohm, 2 x 600 Watts at 4 ohm and 2 x 900 Watts at 2 ohm
  - CV-2800 - 2 x 600 Watts at 8 ohm, 2 x 900 Watts at 4 ohm and 2 x 1400 Watts at 2 ohm
- 2-channel, parallel or bridged mono operating modes for flexible application 900 Watts for CV-900, 1800 Watts for CV-1800 and 2800 Watts for CV-2800
- Independent limiters for each channel reduce overload distortion
- Independent input level controls for each channel allow precision adjustments
- Precise signal and clip LED indicators to monitor performance, allow you to correct for overloading (clipping) condition
- Low-frequency filters (40 Hz) remove rumble and subsonic frequencies
- Twin-tunnel and two temperature-sensitivity forced-air cooling system to maintain a low operating temperature during use
- Balanced XLR or balanced 1/4-inch TRS Combination input connector for each channel and LINK ports
- 5-way output binding posts or Speakon® connectors enable secure operation
- High-current toroidal transformer for absolute reliability
- Independent DC and thermal overload protection on each channel automatically protects amplifier and speaker from damage or failure
- The CV-Series can be mounted in any standard 19" rack

# FRONT PANEL CONTROLS

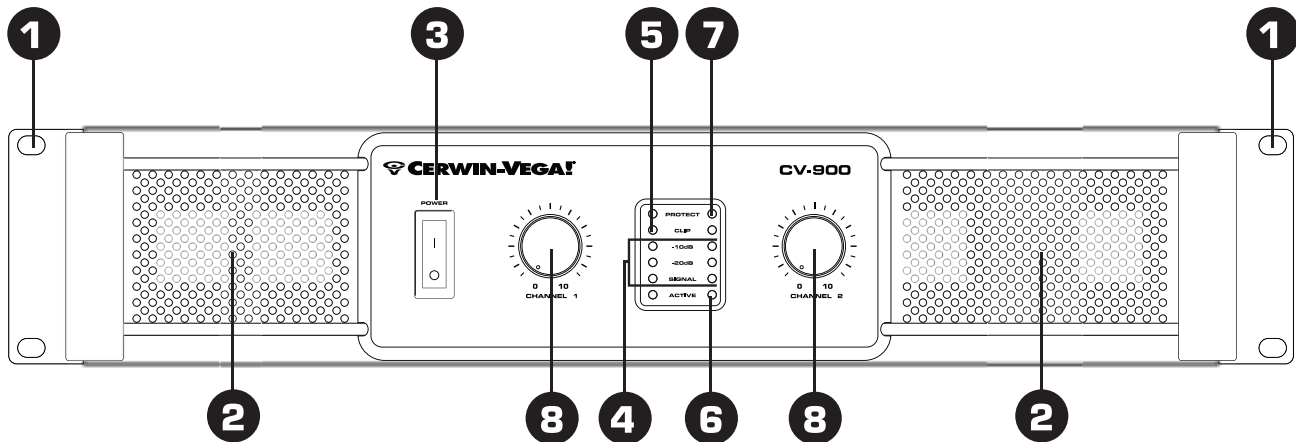

## 1. Rack Ears

These ears are used to mount the amplifier in any standard 19" rack.

## 2. Fan Vent

The CV-Series amplifiers are cooled by two rear-mounted fans (except for CV-900 which is cooled by a single rear mounted fan). Cool air flows through the front fan filters, reducing the temperature of internal components while forcing the heat out the rear vents. Never block these vents and keep them clean at all time.

## 3. AC Power Switch

This switch powers the unit on and off.

## 4. Signal Indicators

These blue LED's will illuminate to indicate that a signal is present at the amplifier input, and that the signal is being amplified.

## 5. Clip Indicators

These red LED's will illuminate at the clipping threshold. These lights should not light up during normal use as they indicate signal outside of the amplification range of the amplifier. When a signal is "clipped" and the clip indicator illuminates, it means that the signal is being distorted at the output stage. Prolonged clipping can not only damage your amplifier, but also your speakers, so be careful to monitor the clip indicator during setup and use. If the clip indicator is illuminated then simply lower the channel gain or input signal until the indicator does not light.

## 6. Active Indicators

These blue LED's indicate that AC power is connected and the amplifier is turned on.

## 7. Protect Indicators

These red LED's indicate that the channel is in Protect mode. When the channel goes into protect mode all output for that channel will be muted. The protect LED's light when overheating or other severe problems occur. This is to protect any speakers connected to the channel. The LED's also light for approximately five seconds whenever the unit is powered on and fade slowly when the amplifier is powered off.

## 8. Channel input level control

These two 21-position detented potentiometers adjust input level for their respective amplifier channels. In Bridged Mono Mode, only channel 1 level control is used to adjust signal level. In Parallel Mode, both input level control are used to adjust signal level for their respective amplifier channels. At their fully counter-clockwise position, the signal is attenuated by more than 80dB. At their fully clockwise position, the signal is at maximum gain. When 0 dBu of signal arrives at the input jacks and the Channel input level controls are set to their fully clockwise position, the unit delivers full power output.

# REAR PANEL CONTROLS

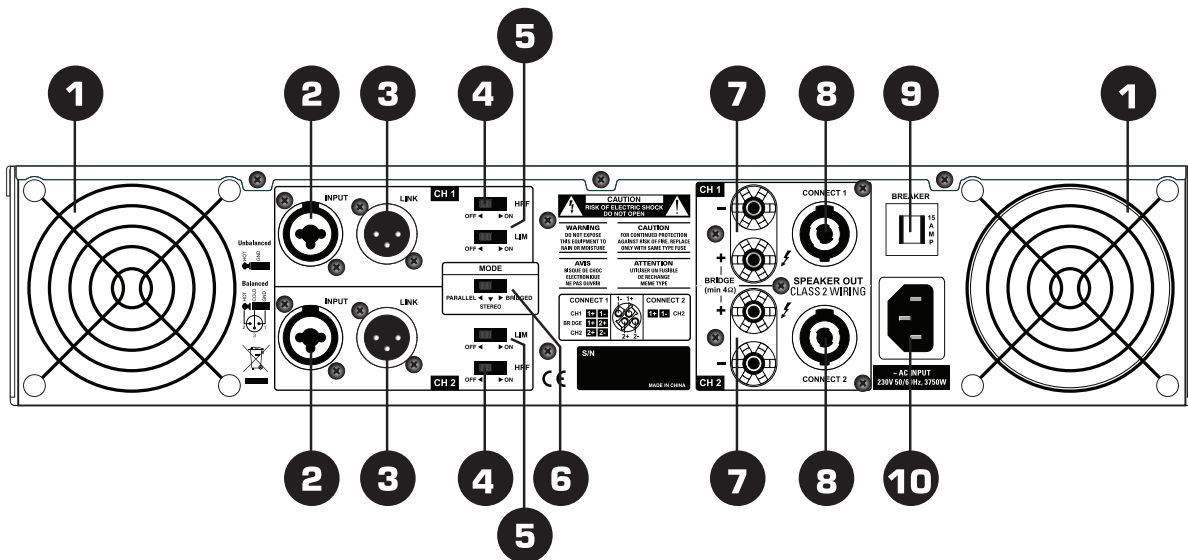

## 1. Fan

This is a variable speed cooling fan. Cool air enters the amplifier through the fan filters located on the front of the amplifier. Be sure not to block these ports when installing the amplifier or other equipment.

## 2. Input connectors

Connect the input source to the balanced combo connectors using either XLR or 1/4" TRS plugs. They are configured as follows : Pin 2 (Tip) hot, Pin 3 (Ring) cold, and Pin 1 (Sleeve) ground. We recommend using balanced three-conductor cabling wherever possible. Unbalanced two-conductor 1/4" plugs can also be inserted into these inputs, but you will get better signal quality and less noise and hum if you use balanced lines. Stereo signal should be connected to the Channel 1 and Channel 2 input jacks. When operating the unit in Bridged Mono or Parallel modes, use the Channel 1 input jack only.

## 3. Link connectors

These jacks are used to send a parallel signal to another device or amplifier.

## 4. High Pass Filter (HPF) switch.

These switches are used to activate the built-in High Pass Filter. The HPF rolls off signals below 40Hz. This improves bass performance by limiting sub-audio cone motion, making more power available for the speaker's rated frequency range. When the filter is turned off, a 5 Hz roll off protects against DC or deep sub-audio inputs.

## 5. Limiter switch

When the input signal connected to your amplifier is too high, you end up with a distorted output signal. To prevent this, both channels feature a clip limiter that can be engaged or disengaged selectively.

## 6. Bridge / Stereo / Parallel switch

This switch changes the amplifier operating mode between stereo, mono bridged, and parallel.

## 7. 5-way Binding Post

Connect each channel of the unit to your speakers. Binding posts are provided for each channel as well as Speakon® connectors, so that paralleling of speakers is possible. Connection to the binding posts can be made with bare wire, banana plugs, or spade lug terminations. Make connections to both the Channel 1 and Channel 2 terminals for Stereo or Parallel Mode, or a single connection across the red terminals only of Channel 1 and Channel 2 for Bridged Mono Mode.

## 8. Speakon® output connectors

You can use these to connect each channel of the unit to 8 ohms or 4 ohms loudspeakers. Using Speakon® speaker cables, make connections to both the channel 1 and channel 2 connectors for Stereo or Parallel Mode, or to the Bridged mode connector for Bridged Mono Mode.

## 9. Circuit breaker

The breaker acts in place of common disposable fuses. This circuit breaker will trip if there is a fault with the main voltage or if maximum output is exceeded. Simply depress the circuit breaker and power up the unit again.

## 10. AC input

IEC connector for AC power cable. Connect the supplied heavy-gauge 3-pin IEC power cable.

## PROTECTION

Every model in the CV-Series incorporates protection features. The front panel Protection LED indicates the activity of the speaker connection relay circuitry in each channel. When the protection LED turns on, this circuitry is active, and all connected speakers are muted.

**Initial power-up** : For approximately five seconds after initial power-up, the protection circuitry is activated and the speaker outputs are muted. If everything is operating normally, you will hear an audible click at the conclusion of this brief period, as the protection circuitry is deactivated and the unit begins delivering signal to the connected speakers. It is normal for the Protection LED to fade gradually after the amplifier is powered off.

**Thermal Protection** : Abnormally high heat sink temperatures will engage the protection circuitry for the overheating channel only. An output relay disconnects the speakers until normal temperature range is restored. The Protect indicator will light to show the protection circuit is active. To guard against this problem, make sure the unit receives adequate ventilation on all sides and that both the front and rear panels are unobstructed. If the power transformer gets too hot, its thermal switch will disconnect all of the secondary power and disconnect both channel outputs.

**Short circuit** : If output is shorted due to faulty wiring, the thermal circuitry will automatically protect the amplifier. If this occurs, the load will be disconnected by the thermal protection circuitry.

**DC Voltage Protection** : If an amplifier channel detects DC voltage at the speaker output, the output relay will immediately open to prevent speaker damage.

**Subsonic Frequency Protection** : The built-in High Pass Filter provides subsonic frequency protection for each channel.

**Current limiting Protection** : At the amplifier's full power limit, or clipping point, the limiter circuitry will be activated. This is indicated by illumination of the Clip LED. The channel gain is automatically reduced, protecting the speakers from high power. Uncontrolled feedback, oscillations, or improper equipment gain setting may activate this circuitry, which is virtually transparent in operation as full signal bandwidth is maintained.

There is reason to be concerned any time the Protection LED lights up (except for initial power-up during approximately five seconds). If this occurs, turn the amplifier off immediately and check all wiring and external equipment carefully in order to locate and correct the condition.

## SETUP

### Clip limiter



Clipping is the result of an amplifier running into power supply limitation. The maximum output voltage that any amplifier can produce is limited by its power supply. Attempting to output a voltage (or current) level that exceeds the power supply limit will result in a flattening effect on the signal. A clipped waveform exhibits extreme harmonic distortion, making it sound harsh or dissonant. The clip limiter detects this and reduces the gain to minimize the amount of overdrive. To preserve as much of the program dynamics as possible, limiting reduces the average program level until peaks barely clip. Each channel has its own clip limiter, which can be switched on or off. When driving full-range speakers, clip limiting reduces high frequency distortion caused by bass overload. It also protects higher frequency drivers from excess overdrive and harsh clipping harmonics.

### HPF (Hi-Pass Filter)



Also known as a low-cut filter, a High Pass Filter rolls off signals below 40Hz. The reproduction of the signal's bass portion is thus optimized, since ultrCV-low, distracting frequencies are eliminated, and more power is available for the reproduction of the wanted segment of the signal.

You should set up the filters so they best suit the frequency response of your speakers, since some speakers are particularly sensitive to over-exursion. The 40Hz filter works well with most compact full-range speakers.

# SETUP

## Mode Select

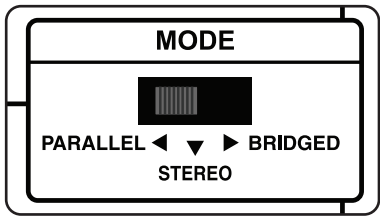

### Stereo Mode

In stereo mode, both channels operate independently with individual input gain controls. Signal at channel 1's input produces output at channel 1, while signal at channel 2's input produces output at channel 2's output. Recommended minimum nominal load impedance for stereo operation is 2 ohms per channel.

### Parallel Mode

When set to Parallel mode, a signal applied to channel 1's input will be amplified and appear at outputs for both channel 1 & 2. The parallel mode is well suited for applications in which driving two speakers with the same signal but with separate amplification. The 'Channel 1' and 'Channel 2' input gain controls individually control the output level on channels 1 and 2.

### Bridged Mono Mode

Bridged mono mode straps both amplifier channels together to make a very powerful, single-channel monaural amplifier. One channel "pushes" and the other channel "pulls" equally, doubling the power over that of either channel alone. Therefore the voltage is doubled, the peak power is quadrupled, and program power is roughly three times as high as that of the individual channel.

Signal is applied to the channel 1 input only and channel 1 input gain control is used to adjust signal level. The input gain control belonging to channel 2 are not used.

**Note :** Bridged mono mode is to be used only when the CV-Series is connected to a 4 or 8 ohms speaker load. Use of Bridged mode with speaker loads of less than 4 ohms can result in severe damage to the unit due to excessive heat and current limiting.



Use extreme caution when operating the amplifier in Bridged Mono Mode. Never ground either side of the speaker cable; the speaker load must "float" away from the amplifier chassis.

# CONNECTIONS

## Stereo Mode

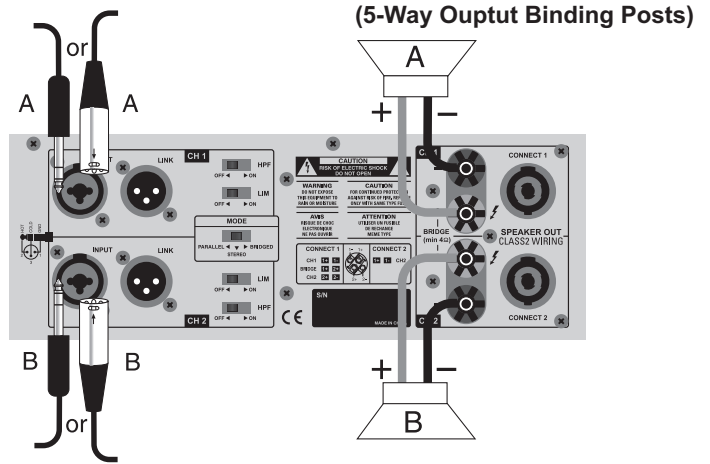

## Parallel Mode

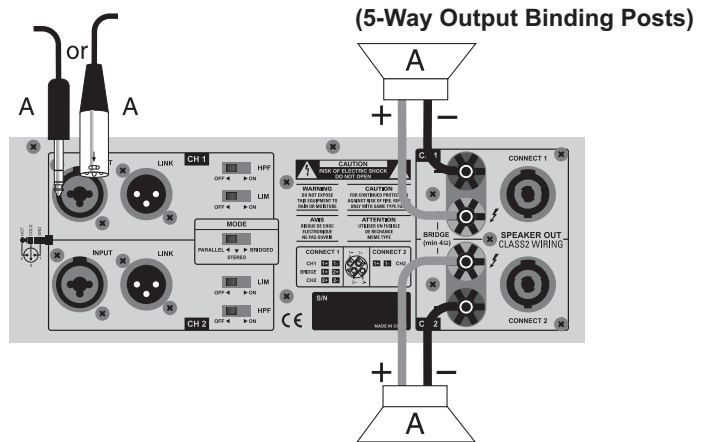

## Bridged Mono Mode

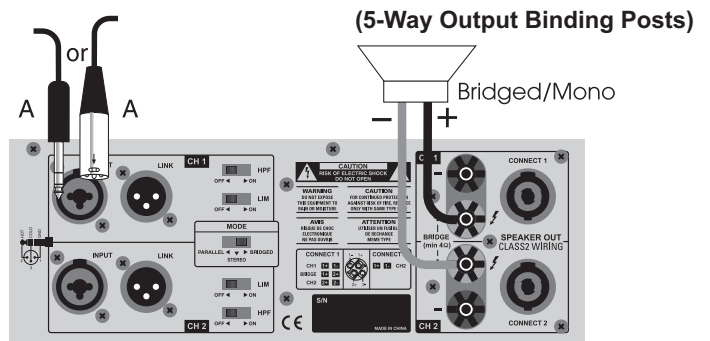



# CONNECTIONS

## Stereo Mode

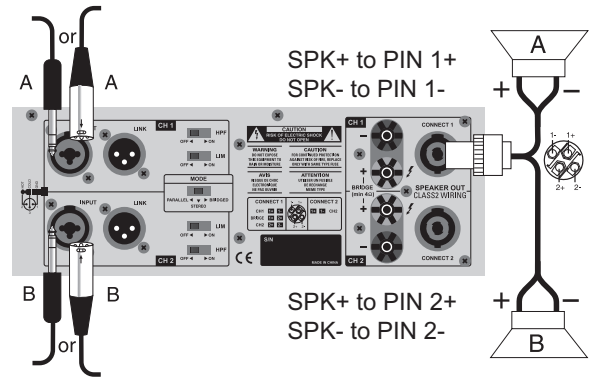
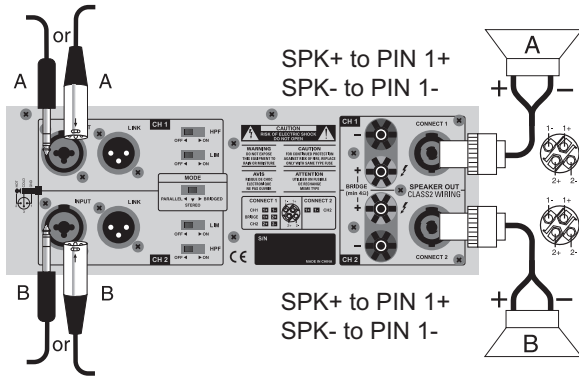

## Parallel Mode

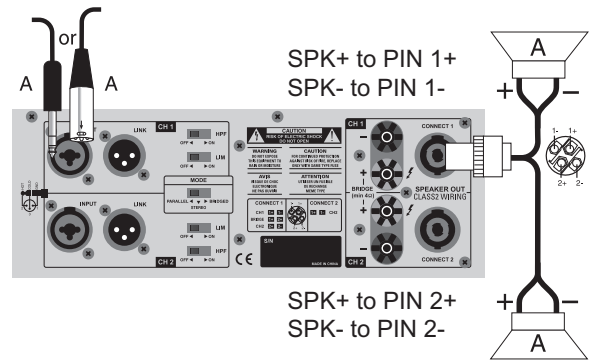
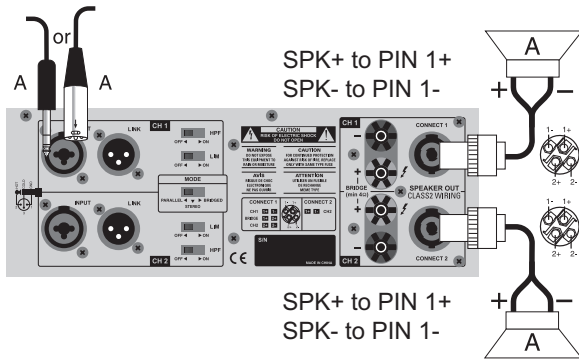

## Bridged Mono Mode

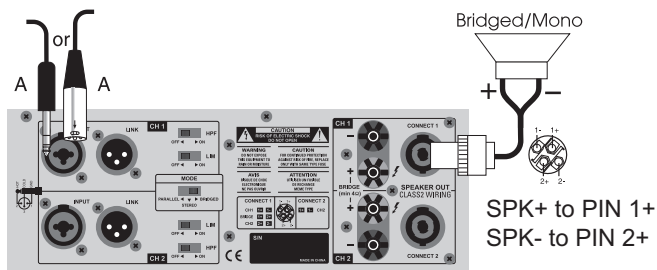



# WIRING

These are several ways to interface to the amplifier to support a variety of applications.

## Unbalanced 1/4" Connector

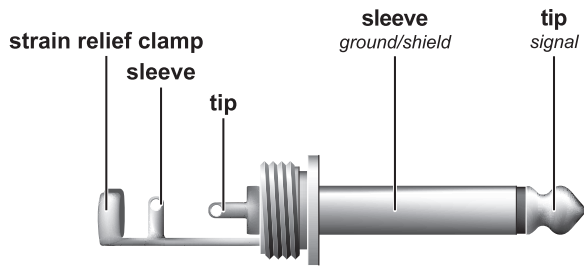

## Speakon® Connector

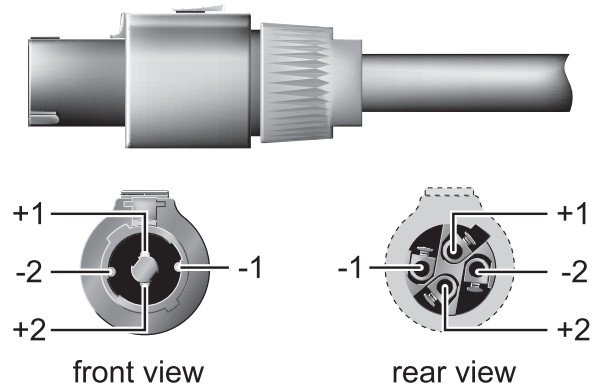

## Balanced TRS 1/4" Connector

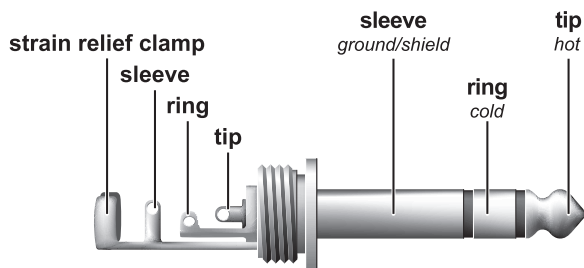

For connection of balanced and unbalanced plugs, ring and sleeve have to be bridged at the stereo plug.

## XLR Balanced Wiring Guide

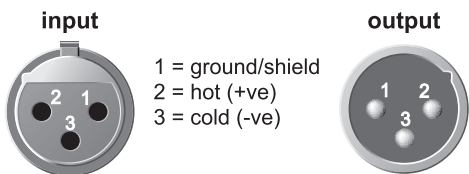

For unbalanced use pin 1 and pin 3 have to be bridged

# SPECIFICATIONS

	CV-900	CV-1800	CV-2800
Rated Output Power	Stereo Both Channel Driven		
8 ohms	210 W	400 W	600 W
4 ohms	320 W	600 W	900 W
2 ohms	420 W	900 W	1400 W
Rated Output Power	Bridged Mono		
8 ohms	650 W	1200 W	1800 W
4 ohms	845 W	1800 W	2800 W
Signal to Noise Ratio (20 Hz ~ 20k Hz)	100dB	102dB	104dB
Distortion (SMPTE-IM)	0.05%	0.01%	0.04%
Input sensitivity @8 ohms	4dBu	4dBu	4dBu
Voltage Gain	30dB	33dB	35dB
Output Circuitry	AB	AB	H
Current Consumption	120Vac / 240Vac		
@ 1/8 power @4 ohms	4.5A / 2.2A	7.2A / 3.5A	8.5A / 4.1A
@ 1/3 power @4 ohms	7A / 3.6A	12A / 6A	17A / 8.3A
@ Rated power @4 ohms	10.5A / 5.5A	19.5A / 9.5A	32A / 16A
Distortion			
20 Hz-20k Hz Half Power	0.01%	0.01%	0.03%
1k Hz Rated Power	0.1%	0.1%	0.1%
Frequency Response	0/-0.5dB ; 20Hz-20KHz, 0/-3dB ; 5Hz-60KHz		
Damping Factor (400 Hz)	200	280	350
Input Impedance	15Kohm Unbalanced, 30Kohm Balanced		
Input Clipping	22dBu (10Vrms)		
Cooling	Continuously variable speed, Front to rear		
Connectors (each)			
Input	Active balanced combo (XLR and 1/4" TRS common use)		
Output	5-way Binding post and Speakon®		
Control			
Front	AC power switch, Channel 1 and 2 volume		
Rear	HPF switch, Limiter switch, Mode selector switch		
Indicators	Active(light blue), Protection(red), Clip(red), Signal (dark blue)		
Protection	Short circuit, Thermal, Current limit, DC offset, Current inrush, RF protection, Turn on / Turn off muting		
Power requirements	100v 50/60Hz(JP) 120V 60Hz(U.S.A. & Canada) 240V 50Hz(EU)		
Dimensions (W _ H _ D)	19"(482mm) _ 3.5"(88mm) _ 16.5"(420 mm)		
Net Weight	28 lb (12.6 kg)	40 lb (18 kg)	46 lb (20.7 kg)

## SPEAKER COMPATIBILITY

The CV Series of amplifiers are designed to work with many different speakers on the market. They have been paired with the following Cerwin-Vega speakers. The following compatibility matrix can be used as a reference. (See: [www.cerwin-veg.com](http://www.cerwin-veg.com) for product specs.)

Amp Compatibility Information with CV Speakers			
Speakers	Amp Model	Amp Mode	
Two INT-152s	CV-1800	Stereo	
Two INT-252s	CV-1800	Stereo	
Two 118S	CV-2800	Stereo	
Two 118S	CV-2800	Bridged	
Two 118S	CV-1800	Bridged	
One 118S	CV-900	Bridged	
Two INT-152s + Two 118S	CV-2800	Stereo	one top + one sub per amp channel
One JE- or EL-36B	CV-900	Bridged	
Two JE- or EL-36B	CV-2800	Stereo	
Two JE- or EL-36B	CV-1800	Bridged	
One AB-36B	CV-1800	Bridged	
One AB-36B	CV-1800	Bridged	
Two AB-36B	CV-2800	Stereo	
Two INT-252s + Two EL or JE-36B	CV-2800	Stereo	one top + one sub per amp channel
Two INT-252s + Two AB-36B	CV-2800	Stereo	one top + one sub per amp channel
Two INT-152s + Two JE- or EL-36B	CV-2800	Stereo	one top + one sub per amp channel
Two INT-152s + Two AB-36B	CV-2800	Stereo	one top + one sub per amp channel
Two INT-252s + Two 118S	CV-2800	Stereo	one top + one sub per amp channel
Four (2 per ch) INT-252s	CV-1800	Stereo	two INT-252s per channel
Four (2 per ch) INT-152s	CV-2800	Stereo	two INT-152s per channel
Four (2 per ch) INT-152s	CV-1800	Stereo	two INT-152s per channel