



REFERENCE MANUAL

dSPEC™
and
Resyn®



Applies to:

dSPEC226 Networked Loudspeaker Processor

dSPEC226AN Networked Loudspeaker Processor

dSPEC226AE Networked Loudspeaker Processor

Resyn® Networked Loudspeaker Management Software

VERSION: 20.15.7.28

EC STATEMENT OF CONFORMITY

This document confirms that the range of products of Community Professional Loudspeakers bearing the CE label meet all of the requirements in the EMC directive 89/336/EEC laid down by the Member States Council for adjustment of legal requirements. Furthermore, the products comply with the rules and regulations referring to the electromagnetic compatibility of devices from 30-August-1995.

The Community Professional Loudspeaker products bearing the CE label comply with the following harmonized or national standards:

DIN EN 55013:08-1991

DIN EN 55020:05-1995

DIN EN 55082-1:03-1993

The authorized declaration and compatibility certification resides with the manufacturer and can be viewed upon request. The responsible manufacturer is the company:

Community Light & Sound
333 East Fifth Street
Chester, PA 19013
USA

Phone: (610) 876-3400
Fax: (610) 874-0190

Chester, PA USA July 2015

About this manual: Every effort has been made to ensure that the information contained in this manual was complete and accurate at the time of printing. However, due to ongoing technical advances, changes or modifications may have occurred that are not covered in this publication. The latest version of this manual, and the most recent product information published by Community is always available at www.communitypro.com/resyn.

REFERENCE MANUAL

dSPEC™ and Resyn®

Table of Contents

EC Statement of Conformity.....	2
Safety Agency Compliance	6
Important Safety Instructions.....	7
L'information de Sûreté Importante.....	8
dSPEC226 Additional Safety and Warning Notices	9
AC Power Requirements	10
Warranty and Service Information.....	10
SECTION I: Getting Acquainted	12
INTRODUCTION.....	12
ABOUT THIS MANUAL.....	12
KEEPING UP TO DATE.....	13
WHAT IS dSPEC?	13
Signal Flow Diagram.....	15
THE BASICS	16
Hardware	16
Software.....	17
SECTION II: Using dSPEC.....	23
INSTALLING Resyn®.....	23
Minimum System Requirements	23
UNINSTALLING Resyn®	24
GETTING STARTED	25
CONNECTING TO THE dSPEC226	26
DESIGNING WITH THE dSPEC226.....	28
Establishing the Connection	32

THE TASK BAR: DROP-DOWN UTILITY MENUS	38
SAVING, STORING, OPENING, AND RECALLING	41
Save and Recall Options in Expert Mode.....	42
Advanced Functions in Expert Mode.....	44
Understanding Resyn Files	46
Saving Speaker Files (Tunings)	49
Recapping STORE, SAVE, RECALL, and OPEN	51
THE SCREEN TABS.....	51
• design System Screen Tab.....	51
Input Section.....	56
Speaker Section.....	58
Uniform Response.....	60
• Protect Screen Tab.....	63
Working with Protective Limiting for Non-Community Loudspeakers	65
More about Protection	66
AMP CAL.....	67
How AMP CAL Works.....	67
Making an AMP CAL Measurement.....	70
About Front Panel LED's	73
• Enhance Screen Tab	73
More on Adjusting Parameters.....	86
Overview of Enhance Screen Views	87
dSPEC Detailed View	88
Input Detailed View.....	91
Speaker Detailed View.....	94
Driver Detailed View.....	94
Output Detailed View.....	95
• Control Screen Tab.....	95
Presets and Wall Control View	96
Operator View	99
Recapping User Presets and Wall Controls	99
• Administer Screen Tab	100
Networking View	101
Firmware View.....	101
Security View.....	102

Diagnostics View.....	103
Resetting dSPEC.....	103
Help!	104
APPENDIX A.....	106
dSPEC File Structure	106
Understanding File Types	106
APPENDIX B	108
dSPEC Configuration Options.....	108
APPENDIX C	109
dSPEC External Control Port Connection	109
APPENDIX D	113
dSPEC Hardware - Front and Rear Panel Views.....	113

SAFETY AGENCY COMPLIANCE



Conforms to UL60065 Standard
Certified to C.S.A. C22.2#60065 Standard

Additional Compliance Information:

This device complies with part 15 of the FCC Rules for a Class "B" computing device. Operation is subject to the following two conditions: (1) This device may not cause harmful interference, and (2) this device must accept any interference received including interference that may cause undesired operation.

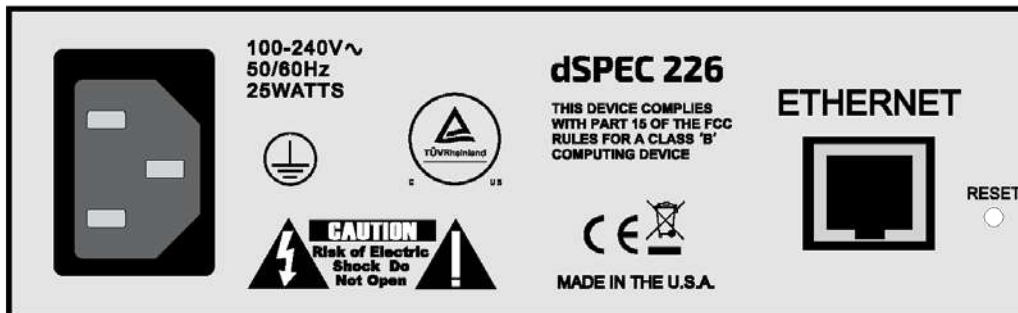





IMPORTANT SAFETY INSTRUCTIONS

Always follow these basic safety precautions when using or installing dSPEC226 processors and accessories:

- Read and keep these instructions.
- Heed all warnings.
- Follow all instructions, particularly those pertaining to electrical connections.
- Do not use this apparatus near water.
- Clean only with dry cloth.
- Do not block any ventilation openings. Install in accordance with the manufacturer's instruction.
- Do not install near any heat sources such as radiators, heat registers, stoves, or other apparatus (including amplifiers) that produce heat.
- Only use attachments and/or accessories that are specified and approved by the manufacturer.
- Unplug this apparatus during lightning storms or when unused for long periods of time.
- Refer all servicing to qualified service personnel. Servicing is required when the apparatus has been damaged in any way, such as if the power cord or plug is damaged, liquid has been spilled, objects have fallen into the apparatus, the apparatus has been exposed to rain or moisture, does not operate normally, or has been dropped.
- Do not expose this equipment to dripping or splashing liquids.
- Do NOT disrupt, disable, lift, or otherwise disconnect the AC Mains ground (earth) connection. In the event of internal electrical problems, an ungrounded apparatus can cause lethal voltage to be present on the front and rear panels, the chassis and other devices that are interconnected to this apparatus.

The terms caution, warning, and danger may be used in this manual to alert the reader to important safety considerations. If you have any questions or do not understand the meaning of these terms, do not proceed with installation. Contact your local dealer, distributor, or call Community directly for assistance. These terms are defined below:

-  **CAUTION:** describes an operating condition or user action that may expose the equipment or user to potential damage or danger.
-  **WARNING:** describes an operating condition or user action that will likely cause damage to the equipment or injury to the user or to others in the vicinity.
-  **DANGER:** describes an operating condition or user action that will immediately damage the equipment and/or be extremely dangerous or life threatening to the user or to others in the vicinity.
-  **WARNING:** To reduce the risk of fire or electric shock, do not expose this apparatus to rain or moisture. Servicing instructions are for use by qualified service personnel only. To reduce the risks of fire or electric shock do not perform any servicing other than that contained in the operating instructions, unless you are qualified to do so.

L'INFORMATION DE SÛRETÉ IMPORTANTE

Veillez toujours suivre ces mesures de sécurité de base lors de l'utilisation ou lors de l'installation des haut-parleurs dSPEC226 processors et de ces accessoires :

- Lisez et Gardez les instructions.
- Observez tous les avertissements.
- Suivez toutes les instructions, particulièrement ceux concernant le calage, support, montage et raccordements électriques.
- Ne pas utiliser cet appareil près de l'eau.
- Nettoyez seulement avec un tissu sec.
- Ne pas bloquer les ouvertures de ventilation. Installer conformément aux instructions du fabricant.
- Ne pas installer près des sources de chaleur comme les radiateurs, les cuisinières, foyers ou autres appareils (y compris les amplificateurs) qui peuvent produire de la chaleur.
- Utilisez seulement les accessoires qui sont spécifiés et approuvés par le fabricant.
- Débranchez cet appareil pendant les orages de foudre ou si inutilisé pendant de longues périodes.
- Référez tout entretien au personnel qualifié de service. Ceci est exigé quand l'appareil a été endommagé de quelque façon, incluant le fil d'alimentation et ou l'embout du fil a été endommagé, des liquides ont été renversés ou des objets sont tombés à l'intérieur de l'appareil, l'appareil a été exposé à la pluie ou l'humidité, l'appareil ne fonctionne pas normalement ou a été échappé.
- N'exposez pas cet équipement à l'égoutture ou des liquides d'éclaboussement.
- NE PAS interrompre, couper, soulever, ou que vous coupiez la mise à la terre CA du secteur (terre). Dans le cas de problèmes internes électriques, un appareil mis à la terre peut causer de tension mortelle pour être présents sur les panneaux avant et arrière, le châssis et autres dispositifs qui sont interconnectés pour cet appareil.

Les termes attention, avertissement, et danger peut être utilisés dans ce manuel pour alerter le lecteur aux considérations importantes de sûreté. Si vous avez des questions ou ne comprenez pas la signification de ces termes, ne procédez pas à l'installation. Contactez votre détaillant, distributeur, ou Community directement pour assistance. Les termes sont définis ci-dessous:

 **ATTENTION** : décrit une condition de fonctionnement ou une action d'utilisateur qui peuvent exposer l'équipement ou l'utilisateur aux dommages potentiels ou au danger.

 **AVERTISSEMENT** : décrit une condition de fonctionnement ou une action d'utilisateur qui peuvent causer des dommages probable à l'équipement et/ou à l'utilisateur et à ceux se trouvant à proximité.

 **DANGER** : décrit une condition de fonctionnement ou une action d'utilisateur qui endommageront immédiatement l'équipement et/ou seront extrêmement dangereuses et qui peut représenter un danger pour la vie à l'utilisateur et à ceux se trouvant à proximité.

 **AVERTISSEMENT** : Pour réduire le risque de feu ou de décharge électrique, ne pas exposer cet appareil à la pluie ou l'humidité. Ces instructions d'entretien sont pour l'usage d'un personnel de service qualifié seulement. Pour réduire le risque de feu ou de décharge électrique n'exécutez aucun entretien autrement que ce qui est contenu dans les instructions d'opérations à moins que vous êtes qualifié pour le faire.

dSPEC226 ADDITIONAL SAFETY AND WARNING NOTICES

1. Read all safety and operating instructions before using this product.
2. Retain all safety and operating instructions for future reference.
3. Obey all cautions, warnings and safety notices in the operating instructions and on the unit.
4. Follow all operating instructions pertaining to safety.
5. Use only high-quality shielded audio and data cables.
6. Do not use this product in the presence of moisture or rain, or near any water, i.e., sinks, swimming pools, wet amplifier rooms or wet basements, etc.
7. Locate this product so that it can receive proper ventilation. Do not use in direct sunlight. Do not place flat against a wall or in an enclosure that will impede the flow of cooling air.
8. Do not place this product near a source of heat such as a stove or radiator.
9. Connect only to a power source that falls within the range as marked on the unit adjacent to the power entry module (100 – 240VAC 50/60Hz – 25Watts).
10. Never remove, disconnect, disable, or lift the AC ground pin on the power cord.
11. Always handle power cords carefully. Never walk on power cords or place equipment on power supply cords. Periodically check cords for cuts or signs of stress, especially at the plug and the point where the cord exits the unit. Do not disconnect an AC power cord by pulling the cord itself to remove it from the power outlet. Instead, grasp the AC plug and remove carefully.
12. Unplug the power supply cord when the unit is to be unused for long periods of time.
13. Take care to prevent objects or dirt or debris from falling into the unit through the ventilation holes or any other openings.
14. Take care to prevent liquids from spilling onto the unit or into the ventilation holes or any other openings.
15. Have this unit checked by a qualified service technician if:
 - a. The power supply cord or plug has been damaged.
 - b. Anything has fallen into or been spilled into the unit.
 - c. The unit does not operate, or operate correctly.
 - d. The unit has been dropped or the enclosure damaged.
16. Do not open or attempt to service this unit. All service work must be performed by a qualified service technician.

AC POWER REQUIREMENTS

The lightning flash with arrowhead symbol, within an equilateral triangle is intended to alert the user to the presence of uninsulated "dangerous voltage" within the product's enclosure that may be of sufficient magnitude to constitute a risk of electric shock to persons.



The exclamation point within an equilateral triangle is intended to alert the user to the presence of important operating and maintenance instructions in the literature accompanying the device.

TO REDUCE THE RISK OF ELECTRIC SHOCK, DO NOT REMOVE COVER. NO USER SERVICABLE PARTS INSIDE. REFER SERVICING TO QUALIFIED SERVICE PERSONNEL.

TO REDUCE THE RISK OF FIRE OR ELECTRICAL SHOCK, DO NOT EXPOSE THIS APPLIANCE TO RAIN OR MOISTURE.

TO REDUCE THE RISK OF FIRE, REPLACE ONLY WITH SAME TYPE FUSE. REFER REPLACEMENT TO QUALIFIED SERVICE PERSONNEL.

WARNING: THIS APPARATUS MUST BE EARTHED

Note: All dSPEC226 loudspeaker processors use a universal input power supply which will accept any line voltage in the range of 100VAC to 240VAC, 50-60Hz, and is exceptionally resistant to voltage dips, or "brown outs." A standard IEC-320 grounded AC inlet is provided on the rear panel to accept the detachable power cord. As there is no ON/OFF switch provided, the AC Mains plug is used as the AC disconnect device whenever it is necessary to fully disconnect from the AC Mains supply.

 **WARNING:** The internal power supply will remain charged, exhibiting potentially lethal voltages for a period of time after the AC Mains cable has been fully disconnected.

 **WARNING:** Never remove the AC earth ground connection to the dSPEC226! The AC Earth Ground Connection is marked on the rear panel by the following symbol:



There are no external fuses on the unit. The power supply fuse is internal. In the event of fuse failure, refer the unit to a qualified service technician for fuse replacement, replacing only with the same type and rating of fuse.

WARRANTY AND SERVICE INFORMATION

The Community dSPEC226 series of Electronic System Controllers are warranted in the USA to be free from defects in materials and workmanship for a period of one (1) year, as determined by one of the following two methods, whichever is longer:

Starting from the date of retail purchase, as noted on the sales receipt from an authorized Community dealer,

- OR -

Starting from the date of manufacture, as determined by the serial number, if the sales receipt is not available.

TRANSFERABLE WARRANTY “(LIMITED)” VALID IN THE USA ONLY

dSPEC226 is designed and backed by Community Professional Loudspeakers. For complete warranty information within the USA, refer to www.communitypro.com/warranty.

To locate your nearest Authorized Field Service Station you can call 610-876-3400. For Factory Service call 610-876-3400. You must obtain a Return Authorization (R/A) number prior to the return of your product for factory service.

WARRANTY INFORMATION AND SERVICE FOR COUNTRIES OTHER THAN THE USA

To obtain specific warranty information and available service locations for countries other than the United States of America, contact the authorized Community Distributor for your specific country or region.

SHIPPING DAMAGE

If the product is damaged during transit you must file a damage claim directly with the freight company. Be sure to save the carton and packing materials, as damage claims can be denied if these materials are not retained. If evidence of physical damage exists upon arrival, be cautious before signing a delivery acceptance receipt. Often the fine print will waive your right to file a claim for damage or loss after you sign it. Make sure that the numbers of cartons shown on the freight documents have actually been delivered.

SECTION I: GETTING ACQUAINTED

INTRODUCTION

Welcome to the world of dSPEC™ and Resyn®. Community has designed the dSPEC loudspeaker controller from the ground-up to perfectly match our range of loudspeaker products. Coupled with Resyn software, dSPEC elevates the performance of Community loudspeakers to an entirely new level, while greatly simplifying the process of commissioning and optimizing any installation – from the smallest to the largest.

Featuring a logical workflow, ease of use, and exceptionally powerful processing capability, dSPEC and Resyn are equally suited for use with a simple pair of R-Series loudspeakers covering a high school football field – to a complex system in which hundreds of loudspeakers are installed in a professional sports venue, a convention center, or a large house of worship - to name just a few examples.

NEW! This latest version of Resyn software has many enhancements and features that we've developed in response to requests from our customers, as well as our own engineer's concepts of how to do things better and more efficiently. Particularly important is the new **Expert Mode** operation which can be ENABLED or DISABLED as desired. When ENABLED, additional displays become available, as well as the ability to save granular file types for use in future installations, or to transfer settings to other dSPEC units. Conversely when DISABLED, the file structure, and some of the display options, become simplified making it quicker and easier to use Resyn when the installation does not require the full suite of Resyn's capabilities. Also new with this release is the ability to connect to dSPECs via network or offsite via VPN.



ABOUT THIS MANUAL

This User's Reference Manual serves two purposes: In **Section I**, we will introduce you to dSPEC™ and Resyn® so that you can quickly become acquainted with the main features and capabilities of these outstanding products. After this brief introduction, **Section II** will provide you with a thorough description of all functions and features, some examples of workflow, and a few tips and techniques to help you optimize your utilization of dSPEC and Resyn to tailor the unique capabilities of these products to your specific needs.

From time to time, we will publish application guides and other information to help you further understand the many possibilities that dSPEC and Resyn offer to the professional sound system designer and installer. Please check our website regularly for updates: (www.communitypro.com).

Note: A printed dSPEC Hardware Manual and a Quick Start Guide are shipped with each dSPEC unit. The Hardware Manual describes how to interface the Inputs and Outputs to the other audio equipment in your sound system. The Quick start Guide provides brief instructions to set up and connect Resyn to your dSPEC system.

Detailed instructions are also provided for making connections to the Control Port and are included with each shipment of Remote Volume Level Controls and Remote Preset Recall Switches (note: these are optional accessories). For your convenience, the Hardware Manual and the Control Port Connection Data Sheets are also included as .pdf files, along with this Reference Manual, on the CD-ROM shipped with each unit.

As you read through this Reference Manual you'll occasionally see **IMPORTANT!** before a specific section or paragraph. Please make sure not to skip that section. This notice precedes any item that might potentially cause harm to your loudspeaker system, or create difficulties in your usage of the products.

When you see **OF INTEREST!** it indicates that there is something you can do with dSPEC or Resyn that may not be obvious without first reading the description.

Whenever we refer to a specific software 'button' on a Resyn screen, we'll usually show it like in this example: **Change Speaker**. This signifies that it's a selection you can make within the software.



KEEPING UP TO DATE

Software and firmware of all types are subject to change, whenever new features requested by customers have been added, or a better way of accomplishing a task has been implemented. dSPEC and Resyn are no exception.

Resyn now automatically checks for software and firmware updates whenever the program is started, provided of course that your computer is connected to the Internet. You no longer need to do this manually. **Note: Resyn does not check at periodic intervals, like some applications, but only when the program has been closed and re-started.**

If you wish to disable this feature you can do so by unclicking the box labeled **Automatically Check for Updates** on the Design System\Options screen.

You can **manually** check for updates at any time by clicking the **Check for Updates Now** button, accessible from the screen mentioned above. Again, you must be connected to the Internet in order to download any updates that are available.

WHAT IS dSPEC?

dSPEC is a **fixed architecture** 4 INPUT x 6 OUTPUT DSP and FPGA based loudspeaker processor. dSPEC provides a host of functions intended to efficiently optimize sound system installations of all sizes - along with certain unique capabilities that are available only from Community.

When we say **fixed architecture** it means that while various Input and Output configurations are optionally available, the maximum internal processing capability is always 4 INPUTS x 6 OUTPUTS. The I/O options are explained in detail below:

The base version of dSPEC, called the dSPEC226, comes equipped with 2 analog Signal Inputs and 6 analog Signal Outputs. A core design feature is that dSPEC can be additionally equipped with as many

as 6 Signal Inputs in various combinations of analog and AES3, but in all cases the internal processing supports a maximum of 4 Processing Inputs x 6 Processing Outputs.

At the time of this writing, three dSPEC Models are available:

- **dSPEC226** – provides 2 analog Inputs and 6 analog Outputs
- **dSPEC226AN** – provides 4 analog Inputs and 6 analog Outputs
- **dSPEC226AE** – provides 2 analog Inputs, 4 AES3 digital Inputs, and 6 analog Outputs

IMPORTANT! In this Manual we will often refer to Signal Inputs and Input Processors, as well as Signal Outputs and Output Processors. Please take a moment to read the following description of what these terms mean so that there will be no confusion as we refer to them throughout the rest of the Manual.

A **Signal Input** provides a means of connecting an external signal to a dSPEC device by one or more of the professional audio interface standards listed below. **Note:** all physical wiring for Inputs and Outputs utilize standard Euro-block solderless detachable connectors (sometimes called Phoenix™ connectors). Available Signal Input types among the various models include:

- (1) A balanced or unbalanced analog line level source (note: two analog signal Inputs are provided as standard equipment on all models);
- (2) An AES3 digital source (AES3 Inputs are available as an option);

Conversely, an **Input Processor** is a block of allocated DSP (Digital Signal Processing) within dSPEC that accepts any one of the Signal Inputs and allows the user to process the signal in a variety of ways. Signal Inputs cannot be summed together, but Input Processors can be summed. More on this later.

Similarly, a **Signal Output** provides a physical means of connecting an output signal from dSPEC to one or more of the following:

A balanced or unbalanced analog line level input; usually one or more power amplifiers. All models of dSPEC provide six analog outputs as standard equipment;

Conversely, an **Output Processor** is a block of allocated DSP (Digital Signal Processing) within dSPEC that provides a variety of functions and ultimately drives a **Signal Output** on dSPEC's rear panel that interfaces with the outside world. The dSPEC Signal Diagram on the following page illustrates signal flow through dSPEC's **Signal Inputs, Input Processors, Output Processors, and Signal Outputs** for all of the various dSPEC models:

SIGNAL FLOW DIAGRAM

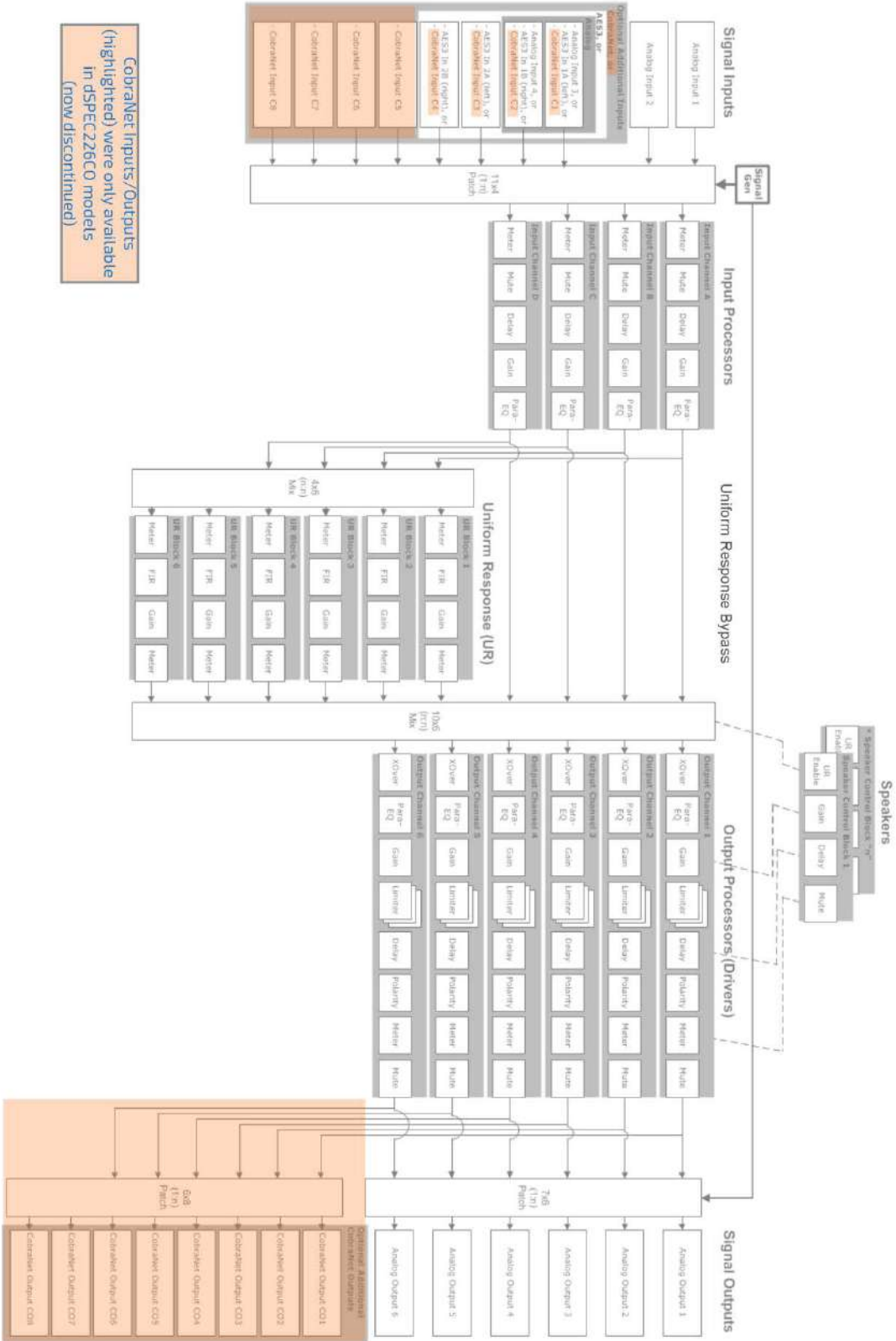

CobraNet Inputs/Outputs (highlighted) were only available in dSPeC226CO models (now discontinued)

There are no controls on dSPEC - not even an ON/OFF switch. All setup and operating functions are made via an outboard PC running Resyn software under Windows® 8, Windows® 7, Windows Vista®, or Windows XP® operating systems. Resyn has been tested and found to function reliably on an Apple MacBook Pro computer running Windows XP® under Apple's Bootcamp. It's also been tested on a Mac and will run under VMware® Fusion and Parallels®.

Though there are no front panel controls, we've provided Input and Output indicators that show signal presence; Input and Output level indicators that display -6dB below FS (Full Scale); Clip/Limit/Mute indicators; and a unique indicator on the front panel called Heartbeat that is labeled like this:



The Heartbeat indicator is a green LED on the front panel that flashes about 3 times every 5 seconds to tell you that your dSPEC is alive and well. If a fault condition occurs, the Heartbeat indicator will stop flashing, or it may flash with a different pattern and/or rate to assist Community's technical staff to diagnose the problem.

THE BASICS

Hardware

Each model of dSPEC is a 1U, 19-inch rack mounting device that connects to your sound system via solderless Euro-block terminals (also called Phoenix Block™ connectors), and then to your laptop computer with a standard Ethernet cable for programming and control. When you leave the job site and take your computer with you, the settings on the dSPECS in your system cannot be changed by others. Please see the **Hardware Manual** that's shipped with each dSPEC for information on how to make physical connections.

dSPEC is an acronym. In this example we'll show you what a **dSPEC226AN** stands for:

- digital
- Speaker
- Protection
- Enhancement and
- Control with
- 2 permanent analog physical inputs (always present in all models)
- 2 additional analog physical inputs (by means of an **AN** expansion card)
- 6 permanent physical outputs (always present in all models)
- **AN** indicates that two Analog Expansion Inputs are included (**note:** AES3 Digital Inputs are also available as options).

A dSPEC equipped with an AES3 expansion card (**dSPEC226AE**) would include the standard two analog inputs, plus the additional 4 AES3 digital inputs. In all model variations the six standard analog outputs always remain present and active.

Please see "WHAT IS DSPEC?" on Page 13 and "APPENDIX D" at the end of this Reference Manual for additional details concerning each of the various models.

Software

Resyn is the software that installs on your PC and allows you to monitor and control dSPEC via an Ethernet connection. Whenever you're ready to install Resyn, please refer to "Installing Resyn" which is found at the beginning of Section II in this Manual.

Resyn accesses dSPEC's unique capabilities by means of a typical Windows® Task Bar that appears across the top of your screen, along with 5 User Tabs. Each User Tab brings up one of Resyn's five Main Screens. The Tabs are named after dSPEC's capabilities, presenting a logical workflow for designing and commissioning a sound system in the dSPEC environment. We like to say, "The name of the product is how you use the product." So just like the name "dSPEC," the 5 Tabs are called:

- design System
- Protect
- Enhance
- Control
- and...
- Administer

Unlike other DSP software, Resyn minimizes the use of pop-up windows that can clutter your screen and create confusion as they appear and disappear. Later in this Reference Manual we'll tell you how to use each of the 5 Tabs, but first here's some general information to help you get acquainted with what dSPEC is all about:

What makes dSPEC different from other loudspeaker controllers?

First and foremost, dSPEC contains a library of Community loudspeakers. By simply selecting a specific loudspeaker model from the library, dSPEC automatically configures and optimizes itself for that particular model of loudspeaker. Your system can be up-and-running in minutes. You do not need to become a DSP expert – in order to achieve expert DSP results!

DSP processing parameters for future loudspeaker models will be incorporated into software updates that are automatically downloaded whenever Resyn has been exited and then re-opened. If you do not wish for Resyn to automatically check for updates each time the program is opened, you can check the box labeled **Do Not Check for Updates** found on the **Design System\Options Screen**. Alternately, updates can be downloaded at any time simply by clicking **Check for Updates Now** on the **Design System\Options Screen**. Of course you must be connected to the Internet to access updates.

Incorporated into dSPEC are FIR based UNIFORM RESPONSE correction algorithms - which no other loudspeaker controller has at the time of this writing. We'll tell you more about the value of UNIFORM RESPONSE in a moment.

You mention a Library of Community Loudspeakers. But aren't some Community loudspeakers usable in both biamplified and single-amplified modes?

Yes, and dSPEC accommodates this. You can choose between single-amplified mode and biamplified mode for any Community loudspeaker that supports those two forms of usage. In the biamp mode, dSPEC intelligently assigns one output for LF and one for HF, plus it automatically sets optimal crossover points. With dSPEC, you never have to establish and adjust crossovers for Community loudspeakers manually – unless you want to.

In single-amp mode, only one output will be assigned. In all modes of operation, the many other operating parameters such as low-pass and high-pass filters, corrective equalization, phase

compensation, crossovers (for biamped models), and protective limiter settings – have all been expertly optimized for you by our engineers. All you need to do is simply select the proper loudspeaker model(s) from the library. It's as easy as checking out a book!

What if I want to change the factory settings?

You can change factory settings at any time. We've provided many of the features and functions that you'd expect to find on a generic loudspeaker controller. For example, you can alter protection settings to match your amplifier's power output capability – or to increase the level of protection for particularly abusive conditions. You can add EQ on inputs and outputs. You can alter low-pass and high-pass filters and change crossover points, slopes, and types. And of course you can introduce digital delay on the inputs and outputs to acoustically align ancillary speakers to a primary sound source, as well as incremental delay to align multiple drivers within an enclosure, or multiple enclosures within a cluster.

Does dSPEC offer any other special features?

Yes. dSPEC provides numerous unique capabilities not found on other DSP controllers. Some of the highlights are listed below:

- dSPEC now offers two modes of operation: Expert and Normal. When the Expert mode is selected, additional functions become accessible. These are explained below in each relevant section. Mainly, they include the availability of granular file types, useful if you want to share specific files among one (or more) additional dSPECS for complex installations involving multiple dSPEC units and/or for transferring files to other dSPECS for future installations. Additionally, the opportunity to view the UNIFORM RESPONSE correction filters on the graphic display screens is activated.
- Loudspeaker protection is handled by three stages of protective limiters: these include a short-term peak limiter to prevent over-exursion of drivers and to control amplifier clipping; a mid-term RMS limiter that prevents system overdrive; and a unique long-term power monitor that works to protect your loudspeakers from long-term thermal damage. All three limiters operate interactively, providing unparalleled driver protection, while allowing each loudspeaker's full dynamic range to be utilized without compromise.
- A built-in **automatic measurement routine called AMP CAL** allows you to precisely measure and record the true gain and actual onset of distortion in each of the amplifier channels in your system, thus ensuring that the protective limiters are properly calibrated and optimized for any supported model of Community loudspeaker. AMP CAL can also be used with other brands of loudspeakers, simply by manually entering the loudspeaker's rated power-handling specifications into Resyn software.
- dSPEC provides 20 filters on each output. Some, or all, may be used as All-Pass filters and/or Phase filters, thereby providing true loudspeaker phase-response correction. Only a few very expensive 'drag and drop' DSP platforms provide similar capabilities.
- Additional filter innovations include selectable VAR Q low-pass and VAR Q high-pass filters, which permit the user to generate under-damped response curves. A VAR Q high-pass is useful for Thiele-Small B6 LF port tuning, and a VAR Q low-pass can correct various forms of upper HF driver/horn response deficiencies.

- dSPEC provides six Remote Control Ports that permit remote activation of User-Presets through a simple switch closure, and/or the use of remote Level Controls. This very powerful feature provides a simple and cost-effective means of solving numerous application requirements without resorting to third-party routing and control systems - or other costly alternatives. The use of dSPEC's six Remote Control Ports does not require the presence of a PC in the system. A PC is required only on a temporary basis to run the simple Control Port setup procedure. dSPEC's Control Ports are explained in detail in Appendix "C" in this Reference Manual.
- dSPEC is expandable in increments from a 2 x 6 configuration - up to 6 x 6 when used with the optional AES3 digital inputs. However, it's important to note that dSPEC employs a fixed-chain architecture of 4 In x 6 Out DSP Processing Blocks. So while you can select from as many as 6 Signal Inputs, only 4 Input and 6 Output DSP Processing Blocks are able to be utilized at any given time.
- dSPEC features a dynamic range of 115dB from analog Input to analog Output, thanks to Community's proprietary U-O (Ultra-Optimized) balanced-line input circuitry and balanced-line output drivers. Such specification is rarely, if ever, seen in DSP products of a similar price point. Moreover, when using the AES3 Inputs, the dynamic range increases to an industry-leading 118dB, approximately double the S/N ratio of the analog input section.
- dSPEC is expandable, thereby making it effectively "Future Proof." Each dSPEC model has the ability to accept an expansion card. Models dSPEC226AN, and dSPEC226AE each have an expansion card already in place; however, cards can be removed and upgraded, or changed in the field at any time, as your application requirements alter - or as new technologies develop. Firmware Updates for dSPEC will become available, when needed, in order to accommodate future expansion cards.

The world of digital audio is rapidly changing and will continue to do so for the foreseeable future. As new networked audio protocols gain in popularity, and eventually become industry standards, dSPEC will be ready to accept compatible expansion card products.

How can I match dSPEC's protection settings to a specific amplifier? Isn't that a difficult process?

Usually it is, but we've made it easy for you. As mentioned above, we've engineered a unique AMP CAL Connection Port that you temporarily connect to your amplifier's output terminals. After you start the measurement routine in Resyn, dSPEC will calibrate the amplifier's output voltage and other characteristics, intelligently calculating optimal protection settings. The whole process takes between 5 to 20 seconds for each amplifier channel in your sound system. The resultant Amplifier File created in Resyn can be saved into your personal Amp Library for use on other channels of dSPEC - or for use with other dSPEC units - without needing to repeat the measurement process when you start your next project.

How about using dSPEC with loudspeakers other than Community?

Yes, you certainly can. In much the same way that you can alter factory settings for Community loudspeakers, you can also create your own custom settings for single-amped, biamped, tri-amped, quad-amped and other loudspeaker configurations, for any manufactured brand, model, or home-grown loudspeaker system. You can save those settings in your **Custom Speaker Library** to be used as often as you like in future installations.

You mentioned something about Uniform Response. What is it, and why might I wish to use it?

Uniform Response (UR) is a technology that Community uses in dSPEC. Uniform Response acquires hundreds of measurement points throughout a loudspeaker's nominal dispersion pattern, and then calculates that loudspeaker's Acoustic Power Frequency Response (APFR). APFR differs significantly from simple SPL based frequency response measurements in that it takes the power response of the loudspeaker into account, not just the pressure response - which is typically measured at only one, or a few, points in space. The complicated acquisition phase of implementing UR is performed by Community engineers at our factory, and the corrective response curves are locked into the loudspeaker library files that reside within Resyn.

Uniform Response applies a 1024 point FIR (Finite Impulse Response) frequency response correction that precisely flattens the Acoustic Power Frequency Response of each selected model of loudspeaker over its entire operating range - not just for the HF driver, as in some lesser technologies - and not just derived from a few SPL measurements. Think of Uniform Response as a parametric equalizer containing 1024 bands that have automatically and expertly been set for you. What you hear is a vast improvement in definition, clarity, and overall sonic quality. The entire sound field of the loudspeaker is corrected, not just the on-axis SPL response.

Do I have to learn how to use Uniform Response? It sounds pretty complicated.

It is complex, but we've done all the work for you in our factory labs. By simply selecting one (or more) Community loudspeakers from the Speaker Library which is supplied with Resyn software, the proper Uniform Response correction for each specific model is automatically engaged. You don't even need to choose UR ON or UR OFF, though you can toggle ON/OFF if you wish to compare the difference. We think you'll like ON.

Does Uniform Response provide any other benefits?

Yes. Uniform Response does a great job of making different sizes and types of loudspeakers sound very similar to one another. This means you can install the appropriate loudspeaker model for each section of a venue (long-throw, medium-throw, short-throw, etc.), and be confident that uniform sound quality will be heard throughout the room.

And because Uniform Response is based on Acoustic Power Frequency Response instead of SPL measurements, it helps make each model of loudspeaker sound very much the same under widely varying acoustical conditions. A reverberant room will still sound reverberant, while a dry room will still sound dry; Uniform Response is not an effects processor or echo cancellation device. But within reason, the difference in sonic quality between one acoustical environment and another will be significantly diminished.

Updated! Resyn permits the user to see the Uniform Response corrective filters on the Enhance display screen. While this can sometimes be a bit overwhelming, it is very interesting on an academic level and can help the person who's commissioning the system to optimize his/her choices in applying any additional room EQ that might be needed. Whenever the Expert Mode box is checked, a

message appears asking if you want to make the Uniform Response filters visible: i.e. **UR Response Visible**. If you click this box, you will see exactly what UR is doing. Note that the display shows only the UR FIR corrective filters, NOT the corrected acoustic response of the loudspeaker - which typically will be a nearly flat line when measured with an Acoustic Power Frequency Measurement device.

If I don't want to use Uniform Response can I get the old "normal" Community PEQ filter settings back?

Yes, absolutely. The Community Speaker Library includes versions of each loudspeaker with Community's traditional IIR (Infinite Impulse Response) parametric EQ filters. It's entirely your choice.

Can I use Uniform Response with other loudspeakers - I mean those that are not manufactured by Community?

No. Although Uniform Response realization hardware is built into each dSPEC, the complex acquisition equipment that we use at the factory to acquire and implement UR correction curves is not part of the dSPEC design. Therefore, the benefit of UR correction algorithms can only be utilized with Community loudspeakers that are present in the Speaker Library in Resyn.

Why are there no front panel controls on dSPEC?

When we designed dSPEC we had the best interests of our customers in mind (as we always do!). We wanted you to be able to set up and program your Community Loudspeaker installation in as little time as possible, with the shortest learning curve possible, so that you can move on to other work opportunities. Front panel controls are not conducive to meeting either of these goals.

Additionally, front panel controls require a front panel display. Controls and displays are expensive - and the programming even more so. But cost aside, operating any loudspeaker controller from a small front panel display and a few shaft encoders is, at best, a compromise. In effect, you'd have to learn two different modes of utilizing the product; first from the front panel and next from the accompanying software. We think your time is more valuable than that. And because dSPEC is essentially a 'black-box' processor with no user adjustments, when you finish commissioning your installation it's going to stay exactly the way you left it.

Is there a lot I need to learn to program dSPEC?

Not at all. Our Resyn software was carefully designed for busy contractors who don't have time to learn complicated, esoteric systems. We've worked hard to insure that all functions and capabilities are simple and intuitive, so that your work can be accomplished quickly and easily - while still providing you with a rich and powerful set of tools that get the job done.

Can I use more than one dSPEC in my system at the same time?

Absolutely. A large number of dSPECs can reside on the same Network at the same time. Additional dSPEC units may be added to a system whenever you wish, without needing to reconfigure the existing units. Please note, however, that Input and Output audio signals do not pass from one dSPEC unit to another. Audio is not transported via the Network, only control commands.

Is Ethernet the only way to control dSPEC? What if I don't want my installations to require a full-time computer to be part of the system in order to make configuration changes?

Many installed systems are not suited for use with a full-time computer. Knowing this, we've designed dSPEC with six Control Ports on the rear panel that you can connect to two types of remote control devices that are available optionally.

The first remote device we offer is the RPS4 Remote Preset Recall Switch Assembly. This optional accessory provides four User Preset selection switches in one easily installed wall mounted unit. Each of the four 'radio-button' style switches provides a simple contact closure that can activate any one of the six built-in dSPEC User Presets. Each of the six User Presets can re-configure any and all dSPEC parameters, thus permitting one dSPEC to be utilized for a variety of different tasks.

For example, at the push of a button you can re-configure a hotel ballroom from a daytime meeting to an evening Cabaret performance that requires a change in position of the head table. The system's delay times, response curves, protection levels, and all other parameters can be altered... just by touching a control switch that could be located anywhere you want it to be, within several thousand meters of cable distance.

The second remote device we offer is the RLC1 Level Control. Like the RPS4 Remote Switch, it can be mounted on a wall, thereby allowing the user to adjust the level of any Input, Output, or even a combination of Inputs and Outputs that you assign to any of the six Control Ports. You can define maximum and minimum permissible levels; in other words, the installer sets the appropriate range of adjustments that can be made by the end-user within established limits. This feature is perfect for systems in venues such as pubs and restaurants in which staff members are permitted to make alterations to the sound system levels throughout the course of their work shift, but only within a pre-defined framework.

Best of all, multiple dSPEC units can be controlled by a single remote contact closure. This feature permits the construction of very complex processing systems at a fraction of the cost of virtually any other present-day solution.

New: We have added Remote Management capability to the software that allows the system integrator to access the dSPECS either via an on-site wireless network or off-site via a VPN connection. See the *Remote Management Manual* for additional information.



SECTION II: USING dSPEC

INSTALLING RESYN®

Before you can use dSPEC you must first install Resyn software on your PC. Resyn is a proprietary application that you'll use to control and adjust all the various models of dSPEC hardware. Resyn runs on standard Microsoft Windows® clients that support .Net Framework 4.0 Client Profile. At the time of this writing, these clients include Windows XP® (Service Pack 3), Windows Vista®, Windows® 7 and Windows® 8.

It helps to have an active Internet connection during installation because the Resyn Installer will automatically download and install .Net Framework 4.0 from Microsoft, if it's not already present on your computer. Alternately, you can manually update your PC with .Net Framework 4.0 Client Profile prior to installing Resyn using the following process:

- inserting the Resyn CD and choose Install .Net from the menu, or;
- run dotNetFx40_Client_x86_x64.exe from the dotNet folder on the Resyn CD, or;
- download and run the .Net installer directly from Microsoft via this link:
<http://www.microsoft.com/download/en/details.aspx?id=17113>.

OF INTEREST: Installing Resyn or the .NET Framework Version 4.0 Client Profile will not overwrite earlier versions of .Net that might be needed by other programs on your PC.

Note that .NET Framework Version 4.0 Client Profile requires a significant amount of disk space, so please make sure that you have enough space available before getting started. Below are the minimum requirements for a successful Resyn installation:

Minimum System Requirements

- A PC running Windows® 7 or Windows® 8, Windows Vista®, or Windows XP® SP3 operating system, or compatible machine such as an Apple Mac running Windows® under Bootcamp, Parallels, or running another VM (Virtual Machine) application. In order to run Resyn on Virtual Machine Software such as Bootcamp, VM Fusion® or Parallels®, your computer's Ethernet connection may need to be bridged to the Virtual Machine. For help with configuring your system you can contact our Technical Applications Group for assistance.
- Intel Pentium 4 CPU or better
- CPU speed of 1.0 GHz or faster
- 512 MB of RAM or greater (1 GB recommended)
- Hard drive space required for Resyn: 20 MB. Additional space required for .Net 4.0 CP: 600 MB for 32 bit; 1.5 GB for 64 bit
- Display resolution of at least 1024 x 768
- Network Interface Card (10/100/1000 Mbps)
- Operating System (OS): Windows® 8 (64 or 32 bit), Windows® 7 (64 or 32 bit), Windows Vista® (64 or 32 bit), or Windows XP® SP3 (Service Pack 3) or greater (64 or 32 bit)

If you prefer to manually update your computer before you install Resyn you can download .NET Framework Version 4.0 Client Profile from Microsoft. The download is free and can be found at: <http://www.microsoft.com/download/en/details.aspx?id=17113>.

If you do NOT have an Internet connection you MUST install .NET Framework Version 4.0 Client Profile from the supplied CD-ROM first, before installing Resyn. In order to avoid any difficulty, we recommend that you have an active Internet connection during the installation process, if at all possible.

Resyn installs much like any other Windows® compatible program. Before installing Resyn it's best to close all other open programs. When you install Resyn from the supplied CD-ROM it normally will auto-run. Simply select **Install Resyn** from the CD menu. If for any reason the CD does not auto-run, or you have downloaded Resyn from the Community website (www.communitypro.com/resyn), find the file named **Resyn Installer.msi** and double click on it to install (see below for hard disk path information).

The Resyn Installer will guide you through the remainder of the process. Once the installation is complete, a desktop icon is automatically created for convenient access to the Resyn application. The icon will look like this:



You can start Resyn by double-clicking on the desktop icon... or you can start Resyn from your Start menu. Simply go to **Start >> All Programs >> Community Professional Loudspeakers >> Resyn** ...and click on **Resyn**.

For future reference, Resyn program files are normally installed in C:\Program Files\Community Professional Loudspeakers\Resyn. File locations can be altered upon installation, if desired, to another folder, partition, or external hard drive; however **.NET Framework Version 4.0 Client Profile** must reside on your primary hard drive and we recommend that Resyn resides on your primary drive as well.



UNINSTALLING RESYN®

If you need to uninstall Resyn, for any reason, you can do so manually. In Windows XP® removing a program is accomplished by using "Control Panel – Add or Remove Programs." In Windows Vista® this same function is found under "Programs and Features." In Windows® 7 it's called "Programs – Uninstall Programs" and is found under the Control Panel Screen. Additionally, if you re-run the Resyn Installer, it will provide the option to uninstall Resyn. In Windows® 8, you can uninstall the software either from the control panel by going to programs then uninstall a program, or you can go to the Start menu (press the windows key). Right click on the software icon, then click "uninstall" below on the options toolbar, then follow any additional steps to remove the software.



GETTING STARTED

Once Resyn is installed and running, you can design your system with or without an actual dSPEC hardware device connected to your computer. Contractors, consultants, and system designers will all be happy to know that with dSPEC you can configure a system from your preferred environment, such as an office - or even an airplane seat - instead of in a cramped amplifier room.

After launching Resyn, you'll see that the opening screen contains the 5 Main Screen Tabs (design System, Protect, Enhance, Control, Administer). It also contains a group of drop-down menus across the top Task Bar named File, Connect, Edit, Venue Preset, Units, Screen, and Help, and a few miscellaneous elements. Each of these will be explained in detail later in this Reference Manual, but this is a good time to mention the Screen options - because if you can't clearly see the screen, then you can't work.

By selecting Screen in the Task Bar, you can choose between a light or dark background to best suit the lighting conditions you're working under. You can also alter the size of the screen fonts to suit the screen size of your computer. We've made it very simple to alter the look at any time that you encounter a change in lighting conditions: Function Keys **F7** and **F8** instantly toggle the background color between light and dark. Function key **F12** increases the size of the screen fonts each time you press it, **<Alt>F12** decreases the size of the screen fonts, and **F11** resets the screen font to the default size.

F9 toggles between full-screen mode and the default window size - or any window size that you might have adjusted to. As simple as these functions may seem, together they comprise a set of very useful features that help you get the job done.



CONNECTING TO THE DSPEC226

The dSPEC226 connects to your computer via a CAT 5e or better Ethernet cable. You can use either a standard cable or a crossover cable, it does not matter as the system will auto-detect the cable type. **NOTE:** make sure to use a high quality Ethernet cable that is known to work properly. Poor quality or damaged cables can cause data errors and may result in lost data or system crashes.

OF INTEREST: If your system uses multiple dSPECS and you wish to have control over more than one unit during the same commissioning session Community recommends using a 100Mbps Ethernet Hub or Ethernet Switch to connect between your computer and your multiple dSPECS.

You can also control one (or more) dSPECS by means of a wireless router, which makes for very convenient operation. With a wireless link you can move about the venue to adjust levels and EQ from the various loudspeaker zones. Resyn can now connect to dSPEC remotely over the Internet. If there isn't an on-site computer managing the system, each dSPEC must have a static IP address and be connected via VPN and a router.

After you open Resyn you'll be greeted by the **design System** screen. Note that all five main tabs (**design System**, **Protect**, **Enhance**, **Control**, and **Administer**) are always present just below the top of the screen and can be selected at any time.



Towards the top of the screen below the 5 Main Screen Tabs, you will see a button that's labeled "Add dSPEC" (see the screen shot above). When you click on this button, a sub-menu will appear.

Load Actual dSPEC from Network Add Virtual dSPEC in Resyn

If you choose **Load Actual dSPEC from Network**, Resyn software looks for existing dSPEC hardware units on the network and loads their existing settings and parameters into the various Resyn screens. Resyn does this via the Load from dSPEC(s) and Connect dialog as described in "Establishing the Connection" on page 32.

Conversely you can design and configure a dSPEC system with or without an actual dSPEC unit (or units) being present. To do this choose **Add Virtual dSPEC in Resyn** and choose from the various dSPEC models:

- dSPEC226 – base unit
- dSPEC226AN + analog input expansion card
- dSPEC226AE + AES3 input expansion card

When adding a new virtual dSPEC in this manner, you can later store the settings to an actual dSPEC by cabling the actual dSPEC and computer together with Cat5 or better cable as described above and then choosing **Connect | Store to dSPEC(s)** from the main menu as described in

"Establishing the Connection" on page 32.

Make sure to choose the correct model of dSPEC to avoid any conflict between the hardware and the software. In the example shown below, we have highlighted the second choice from the top, a dSPEC226AN. This is a dSPEC226 with the added analog expansion card (AN) installed in the unit.

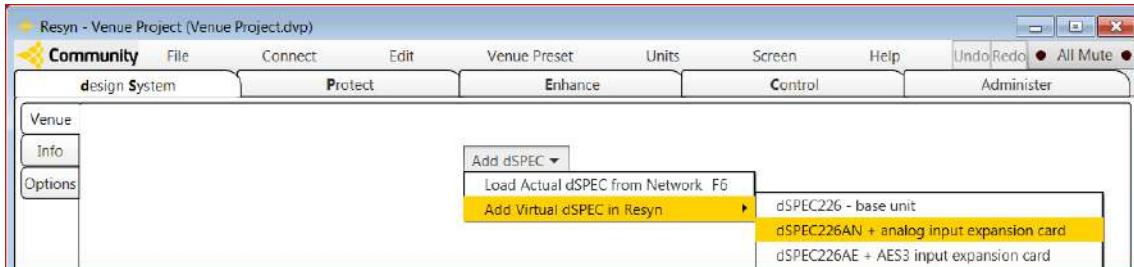

After you have made your choice of dSPEC model, the design System screen will populate with a graphic representation of the selected dSPEC. We refer to this as a virtual dSPEC. From time-to-time we will mention virtual dSPEC in this Reference Manual, as a virtual dSPEC can exist without an actual dSPEC hardware device being present. This feature makes it possible to configure a system, add labels, rough-out filter settings, establish initial delay times, and perform most other tasks without needing the physical unit (or units) to be present.

Additional dSPEC units may be added at this time – or at any later time – by simply clicking on the **Add dSPEC** button, found at the bottom left hand corner of the screen.

After making the dSPEC model selection, the first items you will see are the various selection buttons and text boxes that represent the Inputs and Speaker choices, AS shown in the example below. Whenever you wish to add one or more additional dSPECs, note that the **Add dSPEC** button has now shifted position to the bottom of the screen, indicated by the red arrow. If you wish to delete a virtual dSPEC, perhaps in the event you have mistakenly chosen the wrong model or added too many units, you simply click on **Delete dSPEC** which is also indicated below by a red arrow.

Please note that the red arrows will not be present when you run the actual Resyn software; they are used in this Reference manual to call your attention to specific areas of the screen shots.

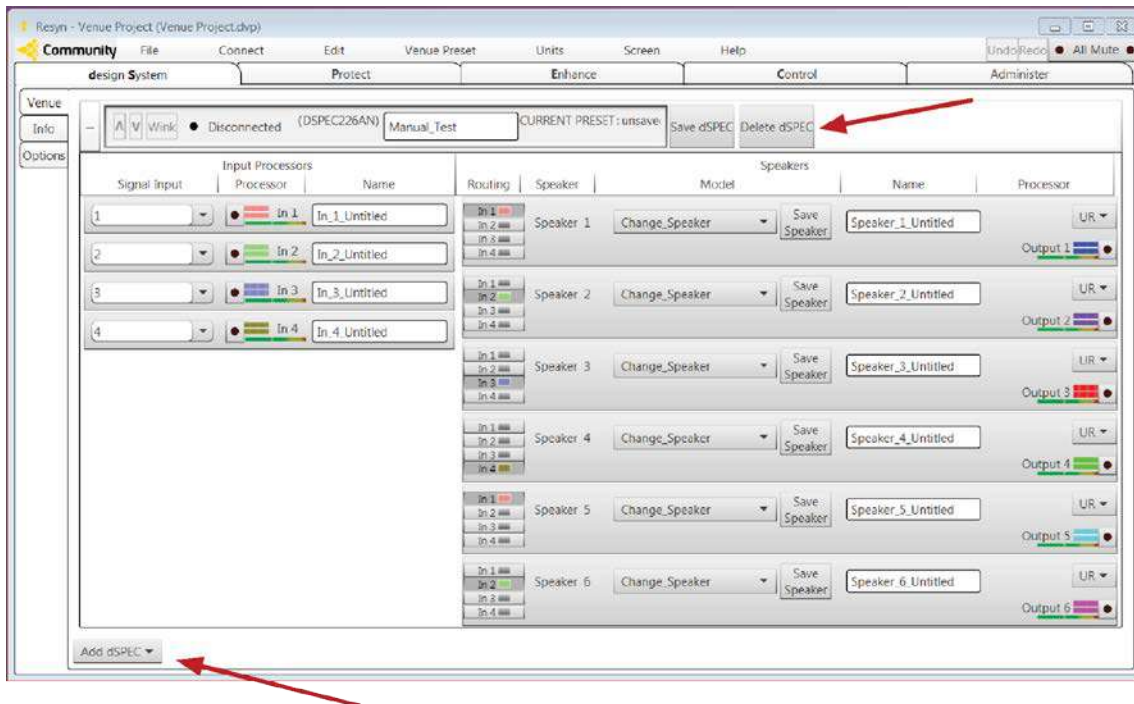

All models of dSPEC work seamlessly together; this means that you can have different models present on the same network at the same time. You can add and subtract dSPEC's whenever you wish, of any model type, with no practical limitation.

IMPORTANT! Dependent upon how you size the window that Resyn resides in, it is possible to inadvertently truncate screen items to the right side of the display screen. A horizontal scroll bar will appear at the bottom of the screen if the window does not contain all of the on-screen information. When the scroll bar is present, the objects toward the right side of the screen should not be inadvertently overlooked.

Designing with the dSPEC226

As we've mentioned above, you can design and configure a dSPEC system with or without an actual dSPEC unit (or units) being present. You can unpack your dSPEC from the shipping carton, connect it to your computer, and begin to configure it for your installation.

Alternately, you can plan an entire system in Resyn software, and at a later time upload the system parameters to an actual dSPEC (or dSPEC's). We'll explain how to do both.

First, let's look at the design and configuration process, then we'll move on to describe how to make the association between the software and the hardware units so that the system you've designed in *software* will be uploaded to the actual dSPEC *hardware* units themselves.

Let's first look at the design System screen. Note the four DSP Input Processors on the left of the screen - just to the right of the Signal Inputs. Depending on the dSPEC model, the available physical Signal Inputs may be greater or lesser than the four Input Processors. Signal Inputs are routed by

simply accessing the drop-down menu and selecting from the available Input list (see the red arrow at the left of the page). In the example shown, the available Signal Inputs are: Signal Generator, None, 1, 2, 3 and 4. The model used in this example is a dSPEC226AN which has two additional analog inputs installed in its expansion slot, in addition to the two Inputs that are always present in the dSPEC226 base model; hence all four analog Inputs, 1, 2, 3 and 4, appear on the drop-down menu.

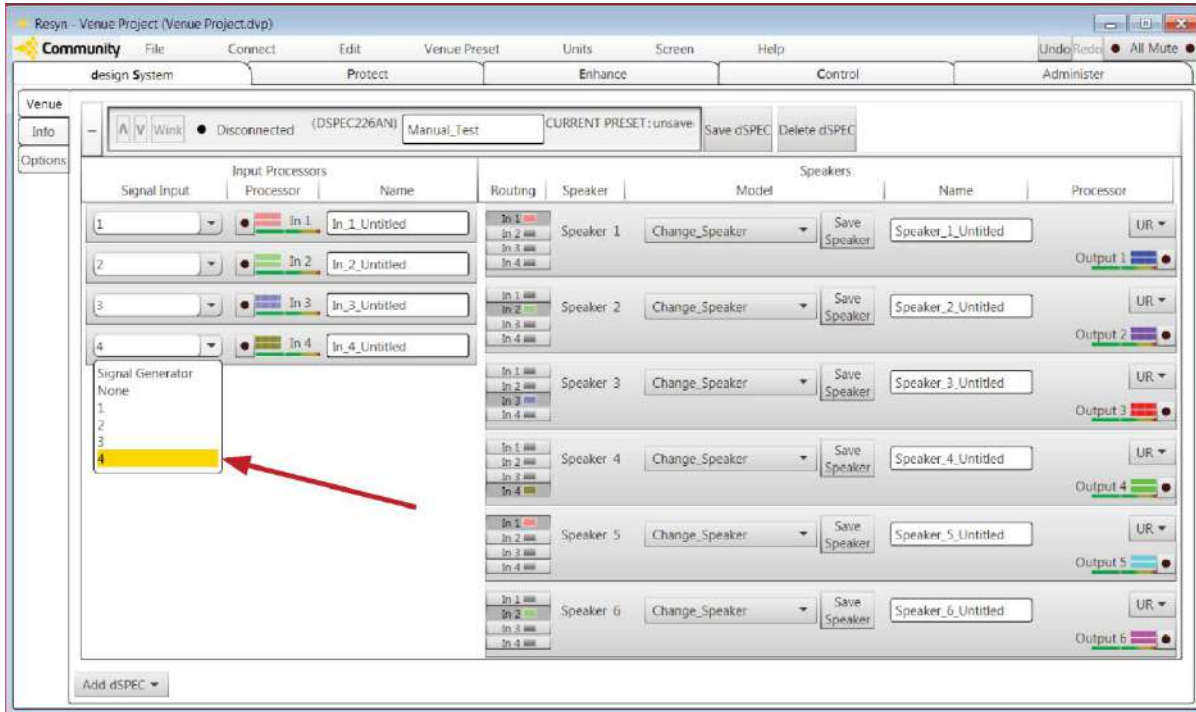

Similar to the two examples described above if your dSPEC is so equipped, the AES3 expansion card will display: Signal Generator, None, 1 and 2 (again, representing the two analog inputs that are always present), and D1 through D4 which represent the four AES3 Digital Inputs depicted in the screen capture displayed below:

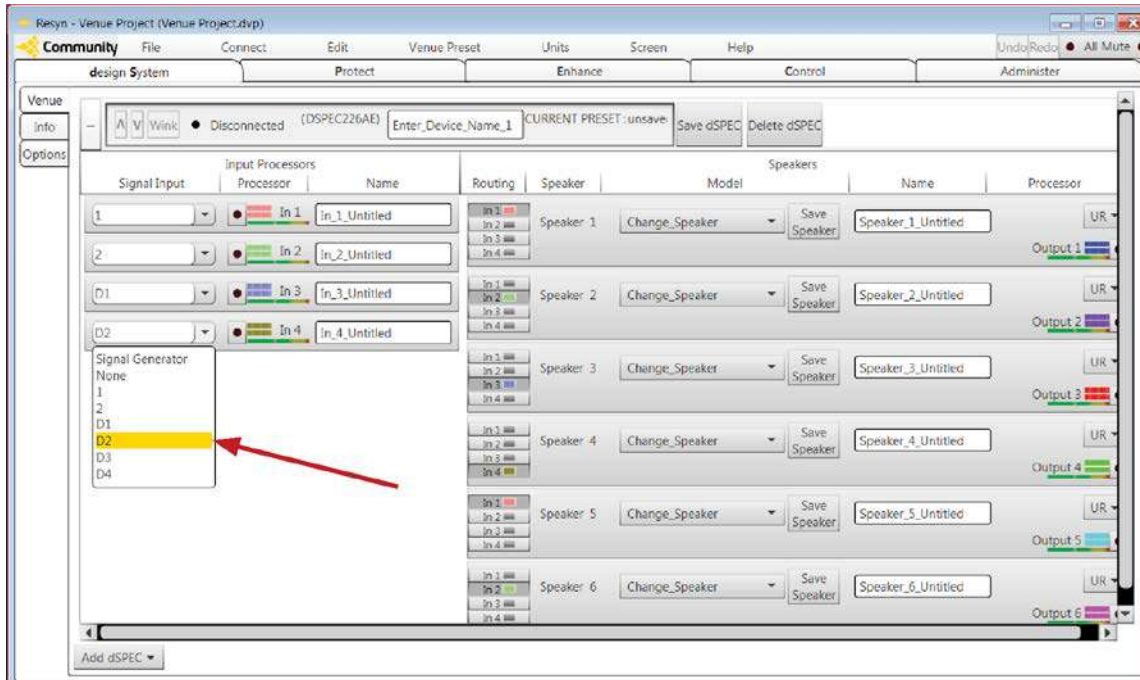

IMPORTANT! Regardless of the number of Signal Inputs that your dSPEC model is equipped with (currently this can be 2 or 4), you will see the appropriate number of *Input Processors* that appear on the left hand side of the screen. As we mentioned above, dSPEC provides up to 4 Input Processors and 6 Output Processors, though the number of Signal Input connections can vary from 2 to 4, depending on the model you've chosen.

To avoid any confusion, think of the Signal Inputs and Signal Outputs as simply a digital patch bay. Though as many as 10 Signal Inputs may be present, only 4 may be selected at any given time and routed to the four Input Processors. The Output Processors permit you to route the six DSP Output Processors to 6 Signal Outputs, but only six *discreet* Signal Outputs can be employed simultaneously. Our use of the term *discreet* refers to an Output Processor that is able to provide unique audio content (filters, delay, etc.) that differs from the other Output Processors in dSPEC.

IMPORTANT! Signal Inputs cannot be summed together. This would be similar to shorting two line level devices with a Y-cord in an attempt to create a mono feed. However, *Input Processors* CAN be summed together because the summing amplifier is in the signal path after the signals are converted to the digital domain.



After you have installed the first dSPEC device, note that the **Add dSPEC** button has now moved to the bottom of the screen as mentioned above (see the red arrow on the screen below). If you want to add additional dSPEC units to your design, simply click **Add dSPEC** again, and repeat the process of selecting the correct dSPEC model as previously described. You can try this now to see how it works without requiring additional dSPEC hardware units. Any dSPEC that you add can always be deleted by clicking the **Delete dSPEC** button found just above the "Speakers" section of each added dSPEC. All three models of dSPEC work seamlessly together, so you can have different models present on the same network at the same time. You can add and delete dSPEC's at any time, of any model type, with no practical limitation.

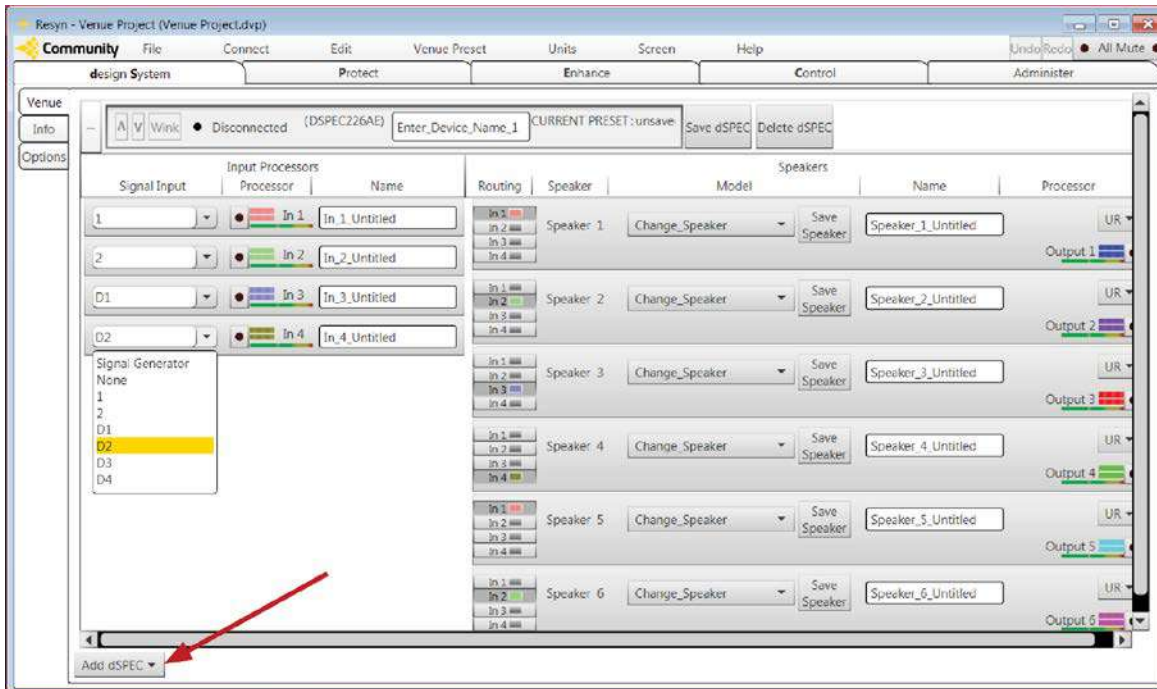

Establishing the Connection

After physically connecting one or more dSPECS to your computer, you will then establish the connection of one or more hardware units to its virtual representation in Resyn through the simple process described below. First, click on the "Connect" drop-down menu at the top of the screen (see below):



Three choices will appear in the **Connect** screen. They are: **Load from dSPECS**, **Store to dSPECS**, and **Disconnect** - along with their associated **F6**, **F5** and **F4** shortcuts. Note that **Disconnect** will be grayed-out if you have not established a connection between a dSPEC and your computer, as there's nothing available yet to disconnect.

IMPORTANT! If you choose Load from dSPECS the parameters stored in each connected dSPEC will be recalled and displayed in Resyn. Conversely, if you choose Store to dSPECS then all the parameters in Resyn (either the factory default parameters, or new parameters that you've entered) will be stored in non-volatile memory in each dSPEC that's connected to your computer.

IMPORTANT! "Store to dSPECS" will overwrite any previously stored parameters in the dSPECS' memory! Be careful not to eradicate your existing parameters accidentally!

IMPORTANT! If you choose **Disconnect**, dSPEC will be disconnected from your computer with no additional notification. However, any settings that were made in Resyn will remain in the dSPEC hardware, just as they were. To restore your session, simply re-establish a connection and choose **Load from dSPECS**. Resyn will then capture the parameters stored in the dSPEC hardware.

IMPORTANT! Make sure *not* to select Store to dSPECS (unless you want to), *or you will overwrite all previously stored settings in dSPEC's memory.*

If you have not executed at least one **Add dSPEC** command, then you will not have any dSPEC units defined on the screen. In such case, the only active option will be **Load from dSPECS**. The command **Store to dSPECS** will be grayed-out, because there is nothing that has yet been defined in Resyn to store to the dSPEC hardware. In all cases, you will only be able to make selections that are actually functional. *This is one of the many intelligent features that we've built into Resyn software to make it easy and convenient to utilize!*



For this next exercise, let's choose "Load from dSPECs." You'll see a new screen appear that's divided into two segments, as shown in the example below:

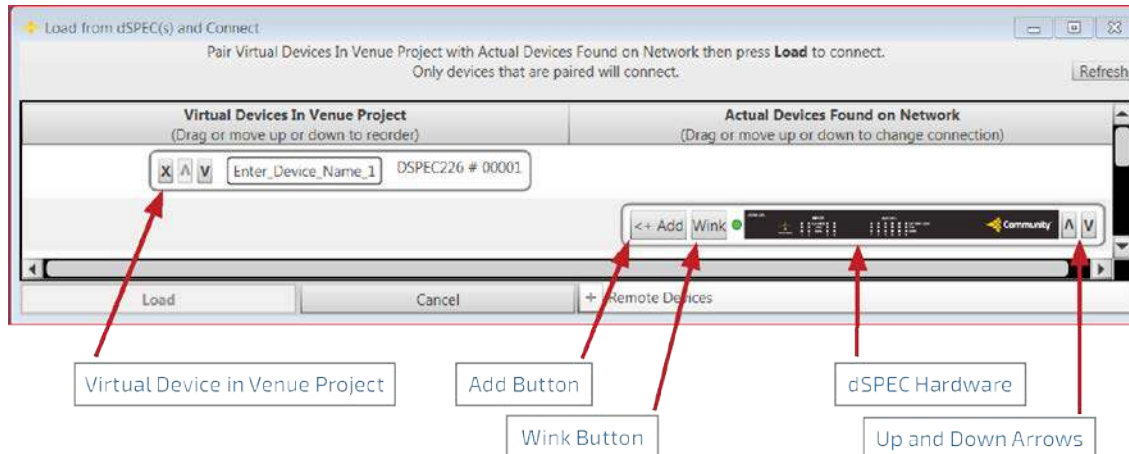

The next step is to make the connection between the *virtual* dSPEC in the Venue Project and the *actual* dSPEC hardware. This can be accomplished either by dragging the dSPEC hardware icon upwards to align with the virtual dSPEC icon or, by using the UP and DOWN arrows to move the dSPEC hardware icon upwards or downwards.

The **Add** button allows you to add an additional dSPEC Venue Project from within the Connect screen. Using this feature adds only the same model as the hardware device on which the **Add** button is clicked –no alternate choices of models are presented. This is a quick convenience feature, as dSPECs can also be added from the design System screen.

Why is associating the virtual and actual devices required?

The 'extra' step of associating virtual designs with the actual hardware units has been designed into Resyn to make it easy to associate a specific dSPEC hardware unit with a specific set of virtual dSPEC parameters in a Venue Project. This feature has significant value whenever more than one dSPEC is being used in a system layout. With this feature, you can quickly select the Venue Project parameters that you want, and then direct them to a specific dSPEC hardware device.

The next screen shot shows a single dSPEC hardware unit associated with a single virtual dSPEC. Note that after association, the WINK button has moved from the dSPEC hardware icon to the virtual dSPEC. If additional virtual or actual dSPECs were present, the UP and DOWN arrows – or dragging and dropping – could both be used to rearrange the associations.

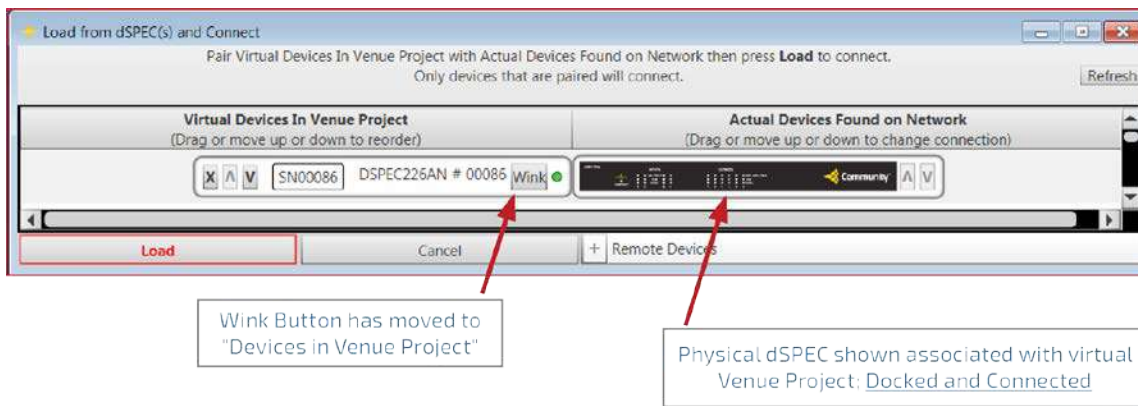

The **left** side is labeled **Virtual Devices in Venue Project**. This represents the one (or more) virtual dSPEC devices that you've added to your project on the **design System** screen in Resyn. When more than one virtual device is present, you can re-order the *virtual* devices by dragging the dSPEC icon that represents each virtual device upwards or downwards. This will cause the dSPEC devices on the design System screen to re-order as well.

On the top **right** side of the screen you'll see the heading **Actual Devices Found on Network**. This represents the *actual* dSPEC hardware devices that are currently connected to the Network and have been auto-detected by Resyn. If more than one dSPEC is present (this requires an Ethernet Switch or Hub), Resyn will detect all additional dSPEC units that are connected and powered up. Auto-detect can take a few moments to execute, especially the first time that it recognizes one or more dSPEC's, so please be patient.

You can also *reorder* **Devices found on Network** (*actual* dSPEC's). Initially, they will automatically load onto the **design System** screen in the order in which they are organized, but you can change their order if desired. They can be re-ordered on Store or Load.

IMPORTANT! Reordering on the **left side** of the screen changes the order of the virtual dSPECs on the design System screen. Conversely, reordering on the **right side** of the screen changes the actual connections between a virtual dSPEC and each dSPEC hardware unit.

The next and last step to completing the association between *virtual* and *actual* is to click on either the **Load** Button or the **Store** Button. These are located at the lower left corner of the "Connect" screen, depending on whether you've chosen "Load from dSPECs" or "Save to dSPECs" from the drop-down menu in "Connect" on the tool bar. The example below shows the Load button.

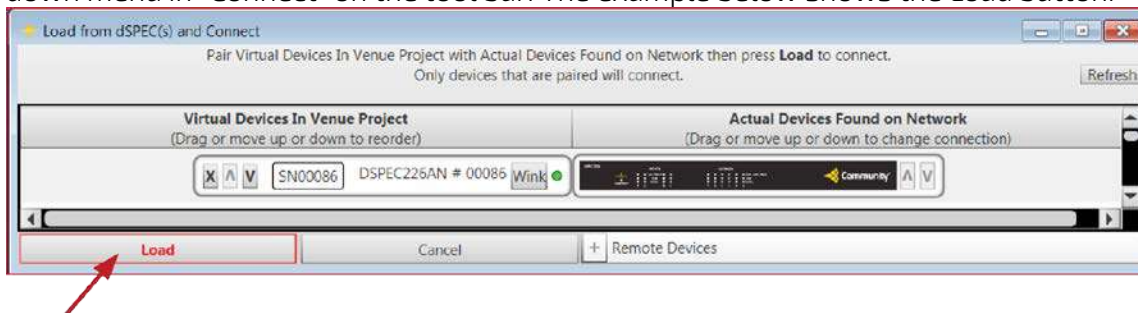

IMPORTANT! If you do not click on either the **Load** Button or the **Store** Button, then the association among the virtual and actual dSPECs will be lost when you exit the "Connect" screen.

OF INTEREST: When more than one actual and more than one virtual devices are present in your system configuration, you can conveniently use the “Wink” command on the actual device icon (that’s the one on the right side) to make sure that you are associating the correct actual device to the proper virtual device. Whenever a Wink command is executed, all the LEDs on the front panel of the physical dSPEC hardware device will flash three times rapidly, indicating that the device is connected and has received the Wink command. This helps you to keep track of how each actual dSPEC device is connected to each virtual dSPEC screen representation (think of this as actual to virtual connectivity), and is especially useful in a large, complex system.

After docking an actual device to a virtual device, the Wink button will move from the actual device to the virtual device verifying that the connection has been established. Now if you click “Wink” in the virtual device, all of the LEDs on the front panel of dSPEC will again flash three times to verify connectivity.

Note that all 5 Resyn Screen Tabs have a **Wink** button in the upper left-hand corner, so that you are never more than a mouse-click away from making sure that each virtual dSPEC in Resyn is connected to the physical dSPEC hardware device that you want it to be connected to.



OF INTEREST: A large number of dSPECS can reside on a single network. It’s even possible to be connected to the Internet and locally connected to one or more dSPEC devices at the same time. This allows you to use Internet resources such as email, while you’re configuring your system.

Please note that you can now operate a dSPEC via an Internet connection, but only one computer can connect to one or more dSPECS at a given time. Please refer to the *Remote Management Manual* for additional information.



Rolling the cursor over the actual device icon on the right side of the **Connect** screen will provide the serial number of the hardware, firmware information, and the IP address as shown in the example below:

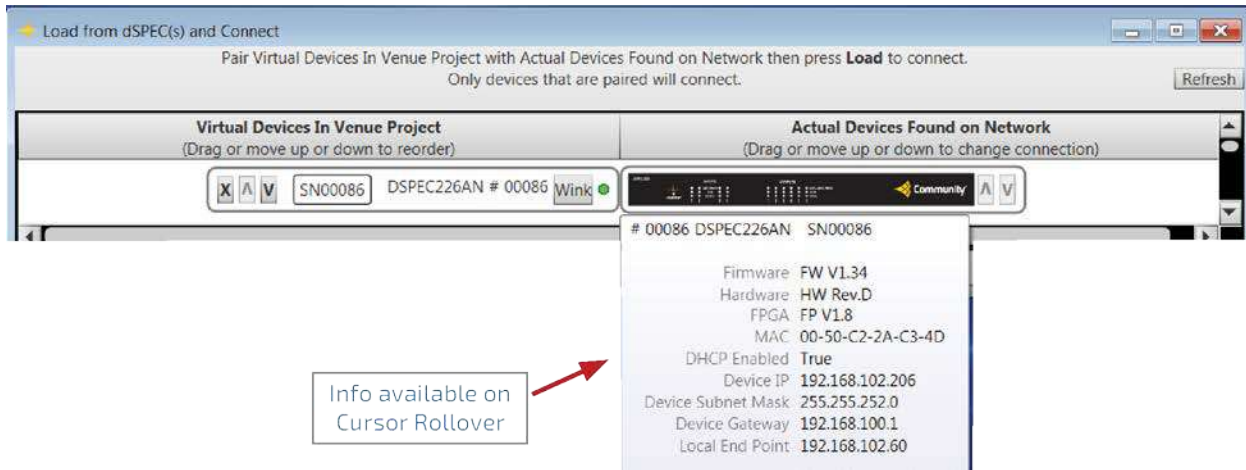

Here's a quick tip on Establishing the Connection: whenever multiple dSPECS are present on the Network, you can reorder the actual dSPEC icons to change how they connect to the virtual dSPEC icons – and vice versa. This may sound confusing, but it's easy to understand when you're looking at the screen and going through the motions yourself. If only one dSPEC is being utilized, then re-ordering does not apply.

Note: In addition to adding more virtual devices in the design System screen, you can also add more virtual devices by clicking on **New** on the *actual* device box in the **Connect** screen. However, this is only possible when you're in the process of executing a "Load From dSPECS" operation. The purpose of this feature is to make it easy to create one (or more) new virtual dSPEC screens that precisely copy the parameters already residing in the dSPEC hardware that you're **Loading** from. This simplifies the process of connecting to an existing Resyn *Venue Project* and loading all of the parameters from a hardware device, without first having to create a new "virtual" *Venue Project* on the design System screen. Just go to **Connect, Load From**, and click **New** on all of the devices in the Venue. Then when you click Load, your existing dSPEC hardware is recreated on the Resyn Software screen. You can now begin editing, or monitoring, your existing *Venue Project*. This option is not available when executing a "Store To" operation.

Note: An "X" also appears on devices in the venue project. Clicking on the X will remove the device from the *Venue Project*. We've made it easy to utilize multiple dSPEC units by providing more than one method of managing your work flow.

The above are Advanced Functions that you may wish to utilize when creating large systems, but probably only after you've become conversant with the other ways of getting up-and-running.



Let's now take a moment to carefully look at the differences between a **Load from dSPECs** and **Store to dSPECs** operation. If you are *Loading* from a dSPEC, you will be transferring all the settings and parameters in that actual dSPEC to the virtual dSPEC that's graphically represented in Resyn.

Conversely, when you are *Storing* to a dSPEC, you will be transferring all the settings and parameters that you've established in a virtual dSPEC in Resyn to the actual dSPEC hardware, thus overwriting any settings and parameters that may already be present in the hardware. It's very important not to confuse these two operations, in order to avoid the loss of previously established settings.



Load Button

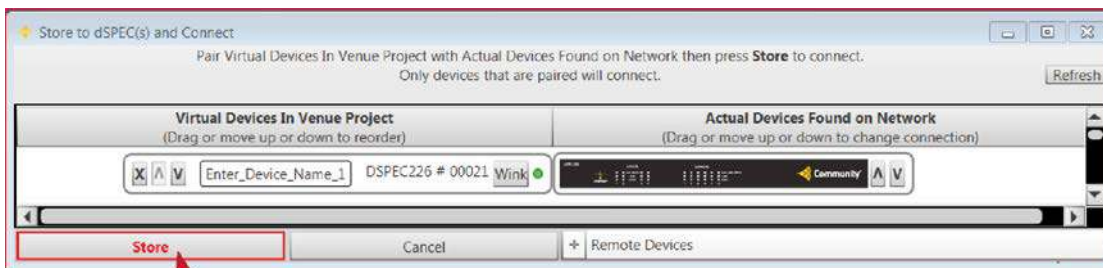

Store Button

IMPORTANT! After establishing a connection, but before you leave the **Connect** screen, you *must* click on the **Load** button or the **Store** button at the bottom-left of the screen or the established connection(s) will not remain in place when you exit the **Connect** screen. Both "Load" and "Store" have slowly flashing red borders to help remind you.

After you click on either **Load** or **Store**, a dialog box may appear asking you to enter your password - if a password has previously been set for the **Venue Project** or for an individual dSPEC. The dialog box looks like this:

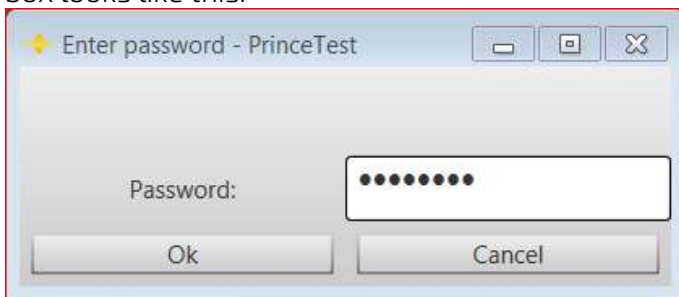

IMPORTANT! If the password has not been changed from the default factory password, the password box will not appear. The factory default password for all dSPECs is **dspec123** (case sensitive). You can change your password in the **Administer** Screen Tab whenever you wish.

If the password box appears (because you've already established a working password), and after you've entered your password, the screen will close and in a few seconds you'll be back to the **design System** screen after dSPEC has processed your connection command. Again, if the password has not been changed from the default **dspec123**, Resyn will skip the password dialog box and you'll be taken right to the **design System** screen. The small round LED-type indicator in the upper left corner of the **design System** screen by the **Wink** button will briefly flash *white* while the connection is being made, then it will change to a steady-state *green*. This tells you that your computer and dSPEC are online together and you can now control dSPEC in real time. To test this, click the **Wink** button on the **design System** screen: all front panel LEDs will flash three times to verify that the connection is active, if the connection has been made properly and recognized.



Note: As you make your way through the 5 Main Screens, you'll see that the now-green LED indicator and the **Wink** button will consistently appear in each of the 5 screens in the same location – the upper left corner. As previously mentioned, clicking on **Wink** will momentarily force all of the LED's on the front panel of the associated dSPEC to flash three times, verifying that the connection is valid. In addition to validating connectivity, **Wink** is very useful for identifying which dSPEC is which, whenever multiple dSPECs are present in an installation. Use the **Wink** button as often as you like to make sure that each dSPEC in the system is docked to the correct virtual dSPEC screen representation in Resyn, and that each is installed in the signal path of the sound system in the way you intend it to be.



THE TASK BAR: DROP-DOWN UTILITY MENUS

Across the top of the screen you'll see six drop-down utility menus on the **Task Bar**. The **Task Bar** is present on all 5 Main Screen Tabs, allowing you to access it at any time without having to navigate away from the Screen Tab that you're currently working within. Each selection is described briefly below, with additional details provided later in this Manual.

- **File.** File enables the creation of a **New Venue Project**, the ability to **Open Venue Project**, and the ability to **Save Venue Project**. "Venue Project" refers to an entire sound system project that uses at least one, or possibly many, dSPEC units. We recommend that you **Save** your **Venue Project** to disk early and often, so as not to lose valuable information. **Saving** will establish a permanent record of each **Venue Project** that you've worked on for future reference.

IMPORTANT! If you select **New Venue Project**, it will be like starting Resyn for the first time. All current information in Resyn will be lost - if it hasn't already been **Saved** with the **Save Venue Project** command.

- **Connect.** This is where you access **Load from dSPEC**, **Store to dSPEC**, and **Disconnect**. The Connect screen is used to manage the relationship between the *virtual* on-screen devices in Resyn, and the *actual* dSPEC hardware devices in your system, as we've described in detail in the previous section.
- **Edit.** Permits the use of *Copy* and *Paste* to save time entering names and nomenclature. The **Edit** drop-down menu also provides **Undo** and **Redo** functions.

OF INTEREST: Note that the **Undo** and **Redo** buttons appear in the upper right hand corner of all 5 Main Screen Tabs, and the standard Windows® Undo/Redo commands (Ctrl+Z and Ctrl+Y), as well as the standard Copy and Paste commands (Ctrl+C and Ctrl+V), can also be used at any time.

- **Venue Preset.** A **Venue Preset** is a global snapshot of *all* the parameters and settings of *all* dSPECS that are present in a Venue Project. dSPEC remembers presets by name - that is of course if you name at least one Venue Preset when you start working. **Venue Preset** stores all parameters to non-volatile memory in each dSPEC hardware unit in the Venue Project, rather than to disk.

To **Store a Venue Preset** to the dSPEC's in your system, or to **Recall** from the dSPEC's in your system, you simply select **Store**, **Store As**, or **Recall** from the **Venue Preset** menu on the **Task Bar**. The name you choose will apply to *all* dSPECS in the system. Note that you must first choose a Venue Preset name using the **Store As** command before you can execute a **Store** or **Recall** command; if no name has been chosen, the **Store** and **Recall** selections will be grayed-out.

OF INTEREST: The name of the current **Preset** always appears at the top of each dSPEC on screen. If you have not yet stored one (or more) Presets, the name will simply be displayed as "CURRENT PRESET: **unsaved**." Then, after you name and store a **Preset** using the **Venue Preset>> Store As** command, the name will change to "CURRENT PRESET: **Paul & Ringo's Club**," ...or whatever else you wish to name it.

IMPORTANT! Whenever you make a change to *any* control in Resyn, the Preset name for that dSPEC will immediately revert to "CURRENT PRESET: **unsaved**." This is important to understand. The changes that you made actually *did* take place in dSPEC's hardware, and will remain in place even if the computer connection is interrupted, but unless you save the changes as a new **Preset** (or overwrite an existing **Preset**), the changes cannot be recalled by name.



As many as 255 **Venue Presets** can be **Stored** to the dSPECS within a Venue Project. The use of Presets opens up a wide range of possibilities, permitting numerous system configurations to be **Recalled** when needed.

By executing a **Store** command, Resyn stores *all* parameters to the internal non-volatile memory of *all* dSPECS in the Venue project under the name of the **Venue Preset** that you've chosen. **Venue**

Preset is a global, system-wide function that works across all dSPECs in the **Venue** project; therefore one **Preset name** can apply to a large number of dSPEC units.

There are other commands discussed below that permit you to **Save** and **Open** the parameters from only *one* dSPEC at a time, and also individually, from select sub-groups of operating parameters - such as Speaker tunings and Amplifier settings - again, one at a time.

IMPORTANT! Each time a **Venue Preset** is **Recalled** the parameters and settings that are stored in the **Venue Preset** will overwrite all parameters and settings that were previously stored in the active memory in *all* the dSPECs in the system. The use of **Venue Presets** is described in greater detail in the next section, as well as other options that Resyn provides to allow you to retain and access data in other ways.

- **Units.** This allows you to choose the *units-of-measure* that you prefer to work with. Delay is available in milliseconds, meters, or feet. Parametric EQ can be viewed in oct/bandwidth or Q (Quality). High-pass and Low-pass filters can be in dB/octave or Order. Amplifier ratings and Speaker ratings may be selected in dBu, Volts, Gain, or even Watts at specified load impedances. Whenever you change **Units**, the change alters *only* the displayed values; it does not affect the operation of any associated functions.
- **Screen.** This drop-down menu allows you to reverse the background color to suit the lighting conditions under which you'll be working. It also permits increasing or decreasing the size of screen fonts to make them easier to read, and there's a selection that restores the screen font size to the default setting. We suggest memorizing the **F7** and **F8** shortcuts; these reverse the screen background color, making it quick and easy to adjust the screen if the lighting conditions were to change from, let's say, a dark amp room... to a bright sunlit ballpark... and then back again. This menu also allows you to view the Resyn software in Full Screen mode whenever you wish.
- **Help.** Provides information on the version of Resyn that is currently installed on your machine, the location of the Resyn File Folders, the version of your OS (Operating System), and other useful information. Additionally, **Help** contains a menu item that will launch this **Reference Manual** whenever you need to refer to it, as well as menu items that access associated documents which you can use to help you plan and commission your system. NOTE: pressing **F1** at any time will bring you directly to this Reference Manual.



SAVING, STORING, OPENING, AND RECALLING

Resyn software automatically **Stores** your parameters and settings to dSPEC hardware as you make changes whenever a dSPEC hardware unit is connected to your computer. Resyn also provides useful options for **Saving** and **Opening** global parameters and settings – or just certain sub-settings – to and from your hard disk drive, or to external storage media. This important feature permits you to **Save to disk** any individual elements that you've defined – such as **Custom Speakers** and **Amplifiers** – for use at a later date.

IMPORTANT! Make sure to save Venue Project early and often to disk.

The quickest and easiest way to **Store** and **Recall** *all* settings and parameters of *all* dSPECs in your system is to use the commands under the **Venue Preset** drop-down menu. They are:

- Store
- Store As
- Recall

IMPORTANT! Note that the **Venue Preset** menu is *always* present on the **Task Bar** at the top of *all* 5 Main Screen Tabs. **Store** and **Recall** are not associated with disk files; they **Store to** and **Recall from** the one (or more) dSPEC hardware units that are connected to your computer.

If you are creating a project offline (no dSPEC hardware connected to your computer), Venue Presets will be **Stored** inside the *virtual* dSPECs in your venue project, and may be **Stored** to dSPEC hardware at a later time.

NOTE: You can *also* **Recall** as many as six **Venue Presets** remotely, by use of the **Control Port** on dSPEC and a Remote switch Assembly. We'll tell you more about this in the **Control Screen** section of this Manual.

We strongly recommend regularly executing a Save Venue command (found under 'File' on the Task Bar), so that you always have a copy of your work on your computer's hard drive for future reference.



Save and Recall Options in Expert Mode

We've already discussed **Storing** Presets and **Saving** Files, but if you need to isolate a single dSPEC - or to isolate individual dSPEC settings - you can do that too, when you've selected Expert Mode. Expert Mode is enabled (or disabled) from **design System>>Options**.

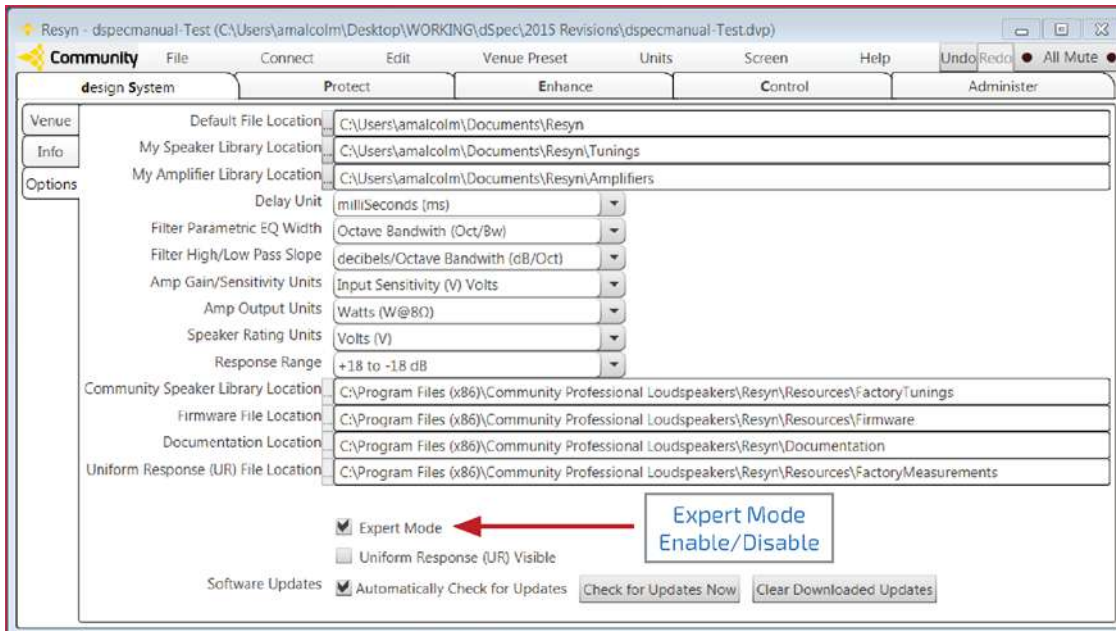

Whenever the **Expert Mode** box has been selected and enabled, another box appears. Directly below the **Expert Mode** box, the **Uniform Response (UR) Visible**, allows the user to see the response curve of the Uniform Response Acoustic Power Frequency Response correction on the **Enhance** screen, and "**Enable Statistics Logging**" will allow our engineers to better understand how you, our customer, is utilizing dSPEC. This will help us to make more effective improvements to the software and hardware as future releases are being planned.



In both the Normal and Expert mode, Resyn allows you to **Store** and **Recall** all settings and parameters on any *individual* dSPEC in the Venue Project, as well as certain individual elements by using other commands that we'll describe below.

Let's look at the nomenclature we use in Resyn, and what it means:

- **Save** and **Open** refer to **Saving** a set of parameters to disk and later being able to **Open** them.
- **Store** and **Recall** refer to **Storing** a set of parameters in the dSPEC hardware itself (in non-volatile memory) and later being able to **Recall** them.

It's that simple! But as these are two distinctly different operations, it's a good idea to keep these terms in mind: **Save** and **Open** relate to settings saved to *disk*; **Store** and **Recall** relate to settings stored to the non-volatile memory in the dSPEC *hardware*.



When you click on the **Venue Preset** drop-down menu on the task bar at the top of the screen, you'll see the following choices: **Recall**, **Store**, **Store As**, and **Remove**. Clicking on **Store As** will bring up a dialog box (shown below) that allows you to enter the name of your project:



You can name it whatever you like such as **Paul & Ringo's Club rev 01**, as shown in the above example. By using Revision Numbers you can easily keep track of parameters that were stored earlier, in case you've made changes to the system - and maybe you're not yet sure if you want to keep them. Or perhaps more than one overall system configuration is desired. Multiple system configurations are often needed when a sound system is to be used in a different manner from one time of day to another, or perhaps for one type of event to another.

You can always *rename* an existing Preset by using the **Store As** command to store the Preset under a new name and then the **Remove** command to remove the Preset with the old name.

IMPORTANT! Remember that the **Venue Preset** function will store *all* of the settings and parameters that you've created on *all* of the dSPECS in your installation under the same **Preset** name. This is a good thing because when you **Recall** a particular **Preset**, by either a software command or by a Control Port switch closure, *all* of the dSPECS in your system will each **Recall** *all* of their own individual settings and parameters - even though you've executed only a *single* **Recall** command.

OF INTEREST: Unless you've stored at least one **Venue Preset**, the other selections on the drop-down **Venue Preset** Menu (**Recall**, **Store** and **Remove**) will be grayed-out and you will be unable to use them. That's because there's nothing yet to **Recall**, **Store** or **Remove**.

After you've executed one (or more) **Store As** commands, then **Recall**, **Store** and **Remove** will become functional. Now, when you click on **Recall**, **Store** or **Remove**, you'll see a list of the **Venue Presets** that you've previously stored (or only a single line item if you've only stored one Preset). You can select from any of them by simply positioning the cursor over the name of the **Preset** that you wish to **Recall**, **Store** or **Remove**. This makes it quick and easy to update a **Venue Preset**, **Recall** a **Venue Preset**, or **Remove** a **Venue Preset**. You simply click on the function that you want, and then move the cursor to the right over the name of the **Preset** that you want, and click once again. This function avoids having to tediously re-enter **Preset** names in order to access them.

Advanced Functions in Expert Mode

Resyn and dSPEC provide the ability to save individual elements within a Venue Project. As described above, we've made it very easy to **Store** and **Recall** global parameters and settings to hardware, while also providing the ability to **Save** and **Open** only the specific data that you might require for more advanced applications.

We recommend that you read through this section to determine how you might want to take advantage of these capabilities, as you begin to think about how you will plan your system. If the system is simple, there's no need whatsoever to learn about **Advanced Functions in Expert Mode**. On the other hand, if the system is somewhat complicated, perhaps consisting of numerous dSPECS, then you may want to become conversant with the Resyn file system so that it can help you to facilitate a current and/or future design project.

Advanced Functions in Expert Mode include the following:

Save dSPEC. By executing a **Save dSPEC** command, you can save the settings and parameters of any *individual* dSPEC in the Venue Project. The **Save dSPEC** button is found on the **design System** screen under the default **Venue** sub-tab as shown below:

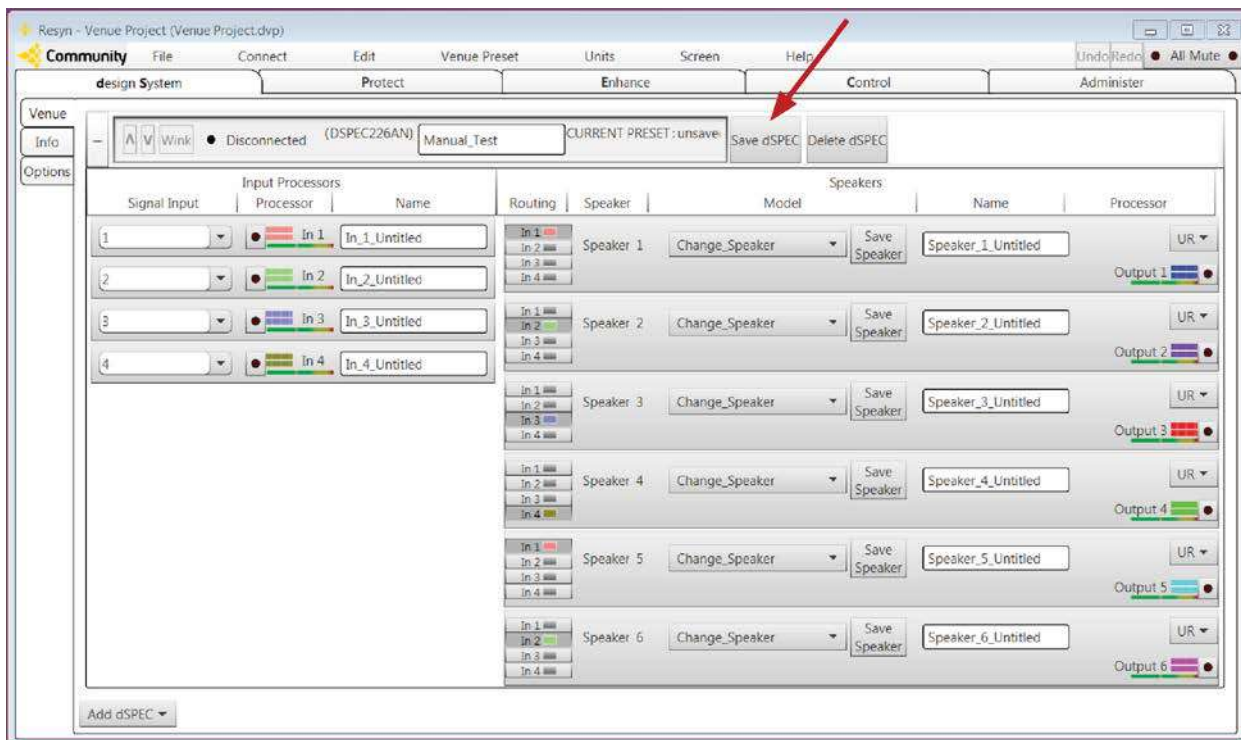

This function can be very useful. For example, if you're satisfied with how you've set up a dSPEC in one zone of an installation (perhaps a group of floor monitors), and you wish to retain those settings for use in another installation at a later date. When you click on **Save dSPEC** you'll be directed to a standard Windows file management screen like the one shown on the next page:

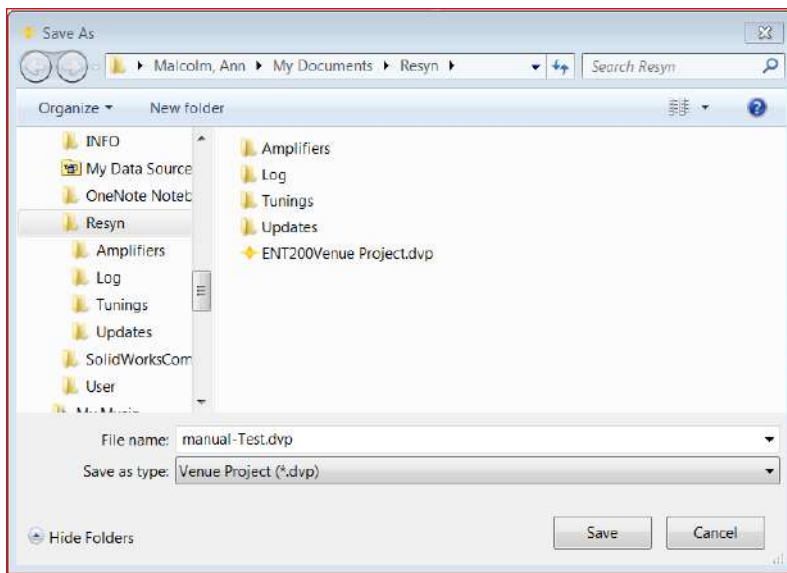

The **Save dSPEC** command will save the parameters and settings of an individual dSPEC to a *disk file*, rather than to the *non-volatile memory* in the dSPEC hardware, so it's important not to confuse these two distinctly different operations.

You can repeat the same process for *any* dSPEC, thereby isolating it from other dSPECs in your system, whenever you may need to **Save** a dSPEC's parameters and settings to Disk on an individual basis. At the same time you can *also* continue to execute a **Venue Project "Save"** command, thus ensuring that the entire system is also **Saved** to Disk as a **Venue Project**.

IMPORTANT! Next to the **Save dSPEC** button is another button called **Delete dSPEC**. This button does not delete the saved disk file but rather, it will delete the virtual dSPEC in Resyn without further warning. Fortunately, if you accidentally press **Delete dSPEC**, all is not lost. The current state of all parameters and settings in Resyn are always stored in the dSPEC hardware – as long as you have a dSPEC connected to your computer. By simply executing the **Add dSPEC** command, followed by **Load from dSPEC** (found under Connect on the Task Bar), the parameters and settings that are stored in dSPEC's non-volatile memory will once again appear on the screen in Resyn.

IMPORTANT! If you do not have a dSPEC connected to your computer (say, for example, you're planning your system from your airplane seat), and you click on **Delete dSPEC**, **your settings for that dSPEC will be lost! There is no auto save-to-disk function!**

OF INTEREST: Whenever you have selected **Expert Mode**, an additional set of commands allow you to **Store, Recall, Save** and **Open** granular files become available in the Control Screen. However the ability to **Save** individual elements including **Save Speaker** in the design System screen, and **Save Amp** in the Protect screen are both *always available*, whether you're in Expert Mode or Normal Mode. These functions are described in detail in each of the individual Screen Sections below.

You can also copy and paste a Speaker from one DSP *Output* block to another. This is functionally the same as saving a Speaker file to disk and then opening it on another output, but without the extra keystrokes.

You can also **Save** and later **Open** an *individual Preset* by using the **Save to Disk** and **Open from Disk** buttons that appear in each dSPEC screen under the **Control Tab**. This allows you to save just a single **Preset** for later use in another installation, or to transfer that **Preset** to another dSPEC in the same Venue Project.

Note that the **Undo** and **Redo** commands which are always present in the upper right hand corner of all 5 Main Screen Tabs will not Undo or Redo any operations related to **Saving, Recalling, Storing, or Opening**. You wouldn't want them to.



Understanding Resyn Files

There are six PC file types for **Saving** and **Opening** dSPEC settings and parameters, to and from your PC disk media. To better understand the structure, we recommend that you read this section if you anticipate that you'll need to isolate some, or all, of the individual parameters for later use.

The six file types are described below. Note that **Venue Project** is at the top of the hierarchy because it saves and recalls *all* parameters and settings of *all* the dSPEC's in your system.

NORMAL MODE

- **Venue Project (.dvp)**
 - **Speaker Tuning File** (Factory Defined **.dtf**, or User Defined **.dtu**)
 - **Amplifier Gain File (.agf)**.

EXPERT MODE

- **Device File (.dev)**
- **Preset File (.dps)**

A **Venue Project (.dvp)** is the root file type. It is the simplest and most important file, and in many cases the only file you will need to **Save** or **Open**. At least one **.dvp** file should always be saved for each **Venue Project**, otherwise the settings and parameters that you've established will not reside on disk, but only in dSPEC hardware. As previously mentioned, a **Venue Project** is the project you're working on and will always consist of at least *one* dSPEC, and possibly many more dSPECs.

A **Venue** project contains all of the parameters and settings for a given installation. It includes all of the data needed to fully **Save** and **Load** a **Venue Project** from the other file types. You can access **New Venue, Open Venue** and **Save Venue** from the drop down menu that appears on the **Task Bar** at the top of the screen in all of the five Main Screen Tabs. You can also use the shortcuts **Ctrl+N, Ctrl+O,** and **Ctrl+S** for convenience, instead of selecting from the drop-down menu.

As with any software, it's always prudent to **Save** your work often. Your computer might develop a problem; a power outage may occur; other unforeseen difficulties could arise. Resyn is no exception to this rule. We recommend that you **Save** a **Venue Project** file whenever you make important changes to your work that would be time-consuming to replicate later.

Even if you have no need to **Save** or **Recall** individual parameters and settings, we recommend that you *always* **Save** a **Venue Project** file so that you can load the parameters and settings that you've established to another dSPEC unit, at a later date, if you need to.



Resyn also provides additional file types so that individual elements of a **Venue Project** can be **Saved to disk** and **Opened from a disk** of any dSPEC, whether it's related to the current project, or intended to be used later in a different project. These are described below:

- **Amplifier Gain File (.agf)**. An Amplifier Gain File contains input sensitivity and gain information of each amplifier that you've defined in your system, as well as any notes that you may have entered. The .agf files can be saved for use at a later date in other projects, or transferred to other dSPECS in the same project.
- **Speaker Tuning File (Factory Defined (.dtf) or User Defined (.dtu))**. These files contain all of the active settings for each *DSP Processing Output* and are defined by the requirements of the Speaker that was selected. In the case of a *Factory Defined* file, all the work has already been done for you at the factory. Each .dtf file contains low and high pass filter data, corrective equalization settings, limiter settings, driver power handling data, and Uniform Response filter coefficients. If the selected Speaker is multi-amped (biamped, tri-amped, or other), the .dtf Speaker File will also contain the settings needed to configure the proper number of outputs, along with all necessary the crossover data.

Conversely, if it's a .dtu *User Defined* file, it will contain all of the settings that you have manually entered. A user defined file can be a file that you have created from scratch - or it can simply be a modification of a factory file that you are using to save your own preferred settings.

EXPERT MODE ONLY

- **Preset File (.dps)** A **Preset File** contains a snapshot of all the active settings and parameters that are stored in only *one* specific **Preset** of only *one* specific dSPEC. It permits you to transfer a snapshot of a single **Preset** from one dSPEC unit to another.
- **Device File (.dev)** A **Device File** contains all settings and parameters for a given dSPEC. It is typically used for transferring all *settings, parameters, and presets* from one dSPEC to another.

IMPORTANT! While many applications require nothing more than simply **Storing a Venue Preset** to the one (or more) dSPECS that are utilized in the project, others may benefit by isolating some, or all, of the individual elements described above, thereby enabling these elements to be accessed at a later date. Please note that the .dps and .dev files are only visible and accessible when you select **Expert Mode**.

The file descriptions that are detailed above *need only be taken into account* if you think that you might need to have access to individual dSPEC elements for use in the future. In essence, they are *entirely optional*. For many, if not most installations, all you need to do is execute a **Save Venue** command under the **File** drop-down menu, and you'll have the backup that you'll need. In any case, you can always go back at a later date and isolate the individual elements - if you need to - as long as you have an *actual* dSPEC hardware device available to you.



Creating and Saving Amplifier Files

dSPEC provides a comprehensive means of entering the power ratings of the various amplifiers in your system. Each amplifier's ratings can be entered either *manually*, by inputting the manufacturer's specifications into text boxes in the **Protect Screen Tab**, or you can use dSPEC's unique *automated* AMP CAL function to accurately measure each amplifier's output voltage. The use of AMP CAL is described in detail under the "dSPEC Protect Screen Tab" on page 63 of this Reference Manual. If you are using one (or more) models of Community Speakers from the supplied library, then the power handling data will automatically be sent to the **Protect Screen** - after you've made your choice from the **Change Speaker** menu in the **design System Screen**.

In all cases, dSPEC uses the amplifier ratings and loudspeaker power handling data to intelligently apply protective limiters, thereby helping to keep your loudspeakers from being damaged by too high an application of power, and/or by excessive distortion due to amplifier overdrive or clipping.

Whether you choose to use the *manual* or *automated* method to establish your amplifier ratings, you'll probably wish to **Save** the data to disk for future use. The data will automatically be **Stored** in the dSPEC hardware, but you can also **Save** it to disk by clicking the **Save Amp** button on the **Protect Screen** that appears directly to the right of the **Change Amp** drop-down menu (see below):

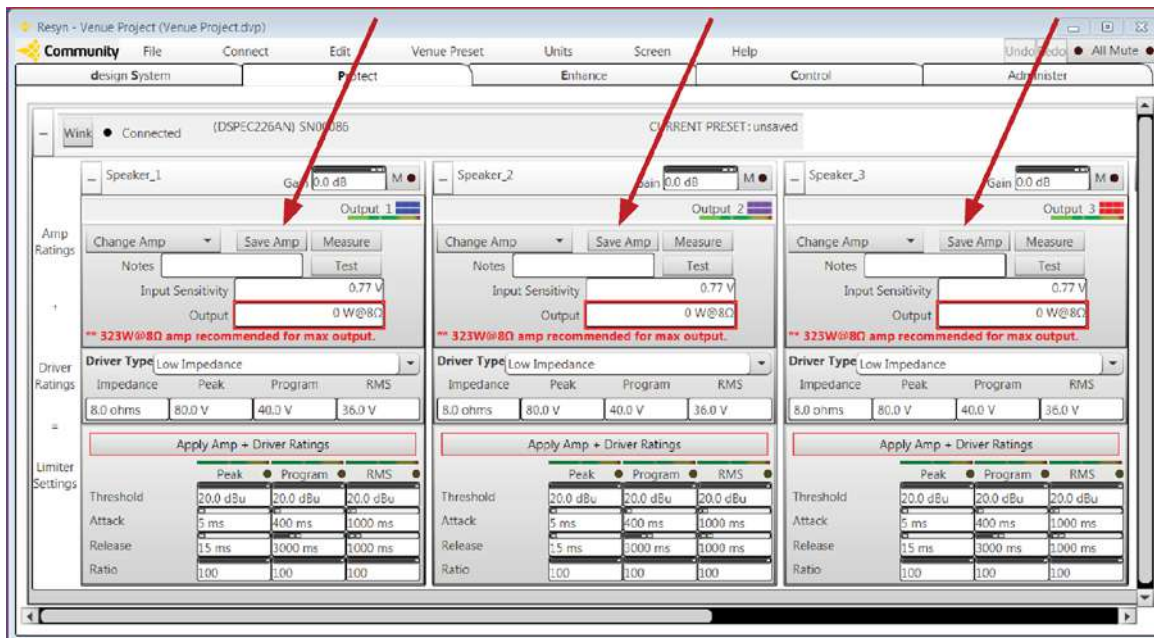

Clicking on **Save Amp** will call-up a standard Windows file management screen like the one that is shown below:

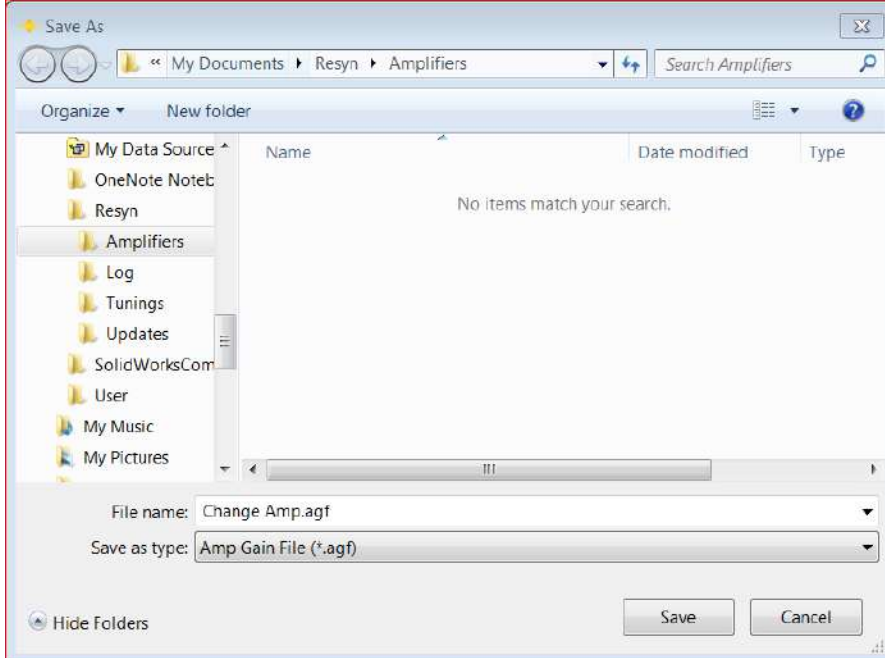

You simply assign a name to each amplifier by overwriting "Change Amp," click on **Save**, and you will be able to **Open** the file at a later date when you need it again.



Saving Speaker Files (Tunings)

In the same way that you can save individual amplifier data (described above in **Creating and Saving Amplifier Files**), you can also save individual Speaker data. This is very useful if you've created your own crossovers, low-pass and high-pass filters, incremental driver offset delay, EQ for a custom loudspeaker or other non-Community loudspeakers, *or*, if you've altered the factory settings of a Community Speaker to suit your particular needs.

A speaker file contains settings for one entire speaker including: name, applicable Uniform Response filter, and the active settings for each DSP Output Processor used by the speaker. It does **not** contain any Input Processor settings or Routing.

It's also worth noting that **Copy** and **Paste** Speaker is now available as an alternative to using speaker files, as we mentioned above. This function is accessible from both the **design System** screen and the **Enhance** screen, allowing the user to quickly replicate a Speaker selection to another *Output Processor* within the same dSPEC, or to another dSPEC in the same **Venue Project**.

Saving a Speaker is as easy as clicking the **Save Speaker** button pointed out by the red arrow in the example below:

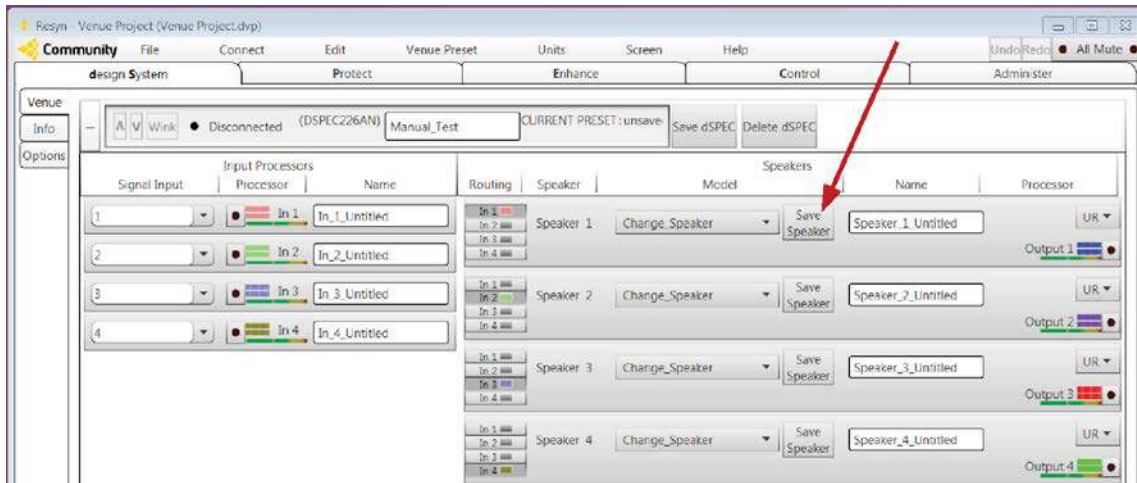

After clicking the **Save Speaker** button you'll see a standard Windows file management screen:

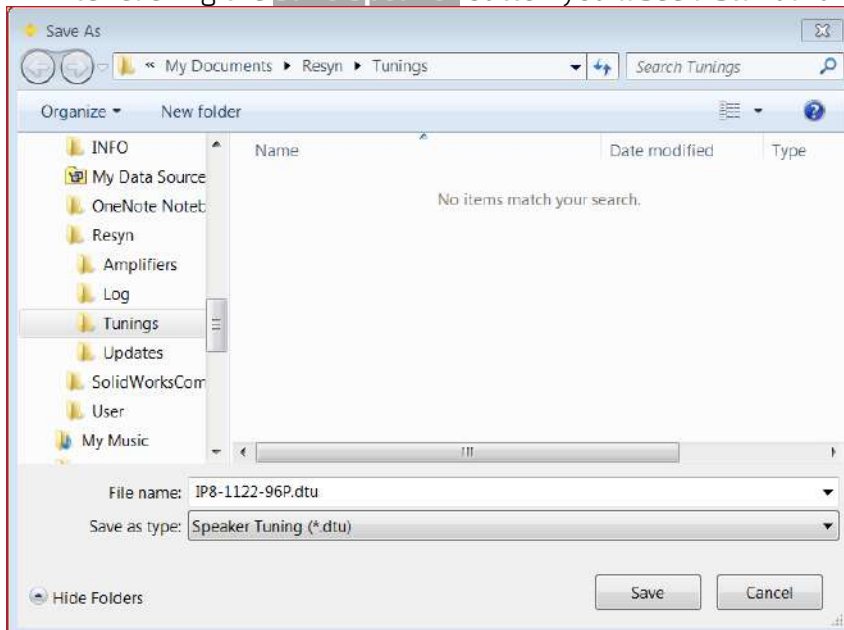

Resyn automatically assigns the correct file suffix, in this case a .dtu file (this is the file type that Resyn uses for a *User Defined Speaker* tuning). Speaker files are saved to disk in a folder named **Tunings** that's found under the Resyn main folder (called *Resyn*) under *My Documents*.



Recapping STORE, SAVE, RECALL, and OPEN

In the section above we've learned that Resyn provides a comprehensive means of managing global settings and parameters of one - or many - dSPECs in your installation, as well as individual elements including **Custom Speakers**, user defined **Amplifiers** - and just about everything else, at every possible level - when in **EXPERT MODE**.

It's a good idea to determine early on, when you first begin to plan and develop your system, how you wish to utilize dSPEC and Resyn's comprehensive data management capabilities. You don't want to overly complicate matters if you don't need to, as it could be confusing to locate the proper files at a later date. On the other hand, if you've spent a lot of time creating *Custom Speaker* parameters (for example), you'll probably want access to the files for future projects, so that you don't have to repeat your work efforts.



THE SCREEN TABS

As previously mentioned, Resyn software is designed around five *Main Screen Tabs*. Whenever you select a *Screen Tab* you get a set of *controls, labels, and displays* that Resyn provides for each logical group of functions. Some screens also have sub-tabs that hold additional information and provide additional functions.

In this section we'll explain how each of the five *Screen Tabs* permit quick and effective system configuration. Let's look at them in the order that they appear from left-to-right at the top of Resyn's always-present master Window. This is also the logical order in which you'll usually want to address your work flow:

- **design System Screen Tab**

This is the first screen you'll see when you open Resyn and use the **Add dSPEC** button to select one or more specific models of dSPEC. At this stage, the **design System** screen has not yet been populated with the various selections and labels that you'll add later. Initially, it will look like the screen capture shown below:

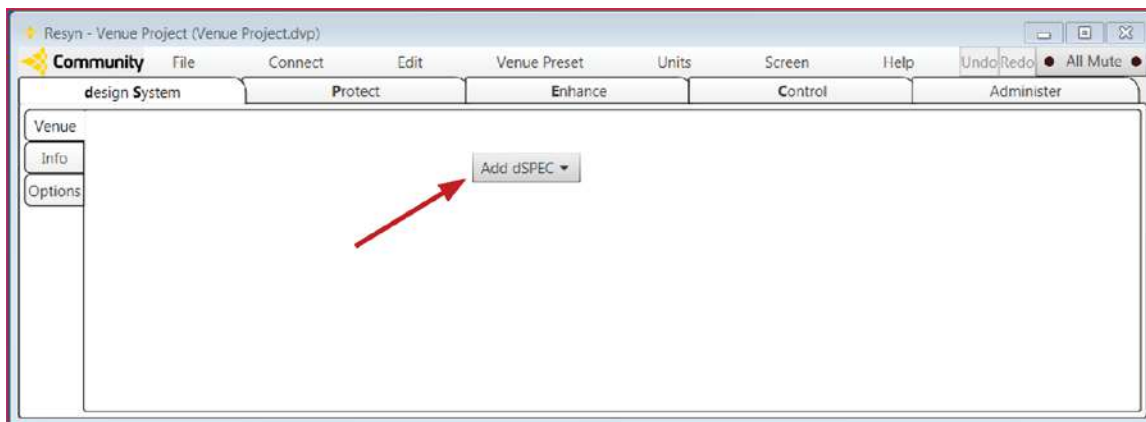

Next, by clicking on **Add dSPEC** a virtual screen representation of a particular model of dSPEC will be added to your **Venue** project. **design System**, just like its name, is where you'll plan and configure your overall system layout. In this screen you'll choose how INPUTS are routed to OUTPUTS, which Community Speakers (or other brand) of speakers you'll be using, and how you'd like to label the various INPUTS, SPEAKERS, DRIVER components and AMPLIFIERS that will be used in your system.

OF INTEREST: Although **design System** is the first screen that appears after selecting a model of dSPEC, it is not where you will control gain, EQ, or other functions that are sometimes found in the top-level screens of other brands of loudspeaker controllers. *That's because we have a different idea of how to do things.* Think of the **design System** screen as a roadmap of your entire **Venue Project**. We use the name "**Venue**" to mean the entire sound system as it relates to dSPEC.

Below is an example of a **design System** screen that has been populated with all the attributes of a dSPEC226AN.

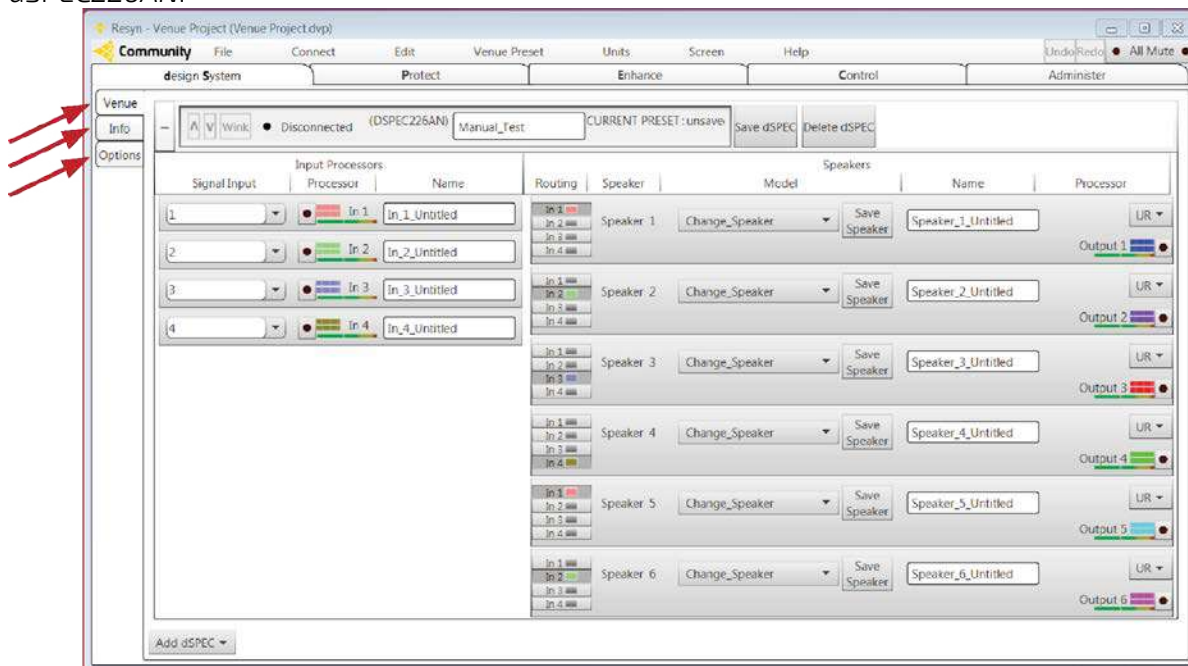

Notice the three buttons at the far left labeled **Venue**, **Info**, and **Options** (see the **red** arrows). Each of these will call up a sub-tab. Let's look at each of them in turn:

Venue (the top of the three buttons) is the 'home' screen where the top level labels and configuration details are always displayed - as long as one (or more) dSPEC(s) have been selected by using the **Add dSPEC** button as described above. If you add more dSPECs, they'll appear under the top dSPEC and can be accessed by using the scroll bar, which will appear on the right side of the screen whenever there's an object to scroll down to. The next example shows two dSPECs with the second dSPEC partially truncated; this illustrates how vertical scrolling may be necessary, depending on your screen size. In this example, the second dSPEC has not yet been associated with the physical unit; therefore, the green Connected LED is not lit:

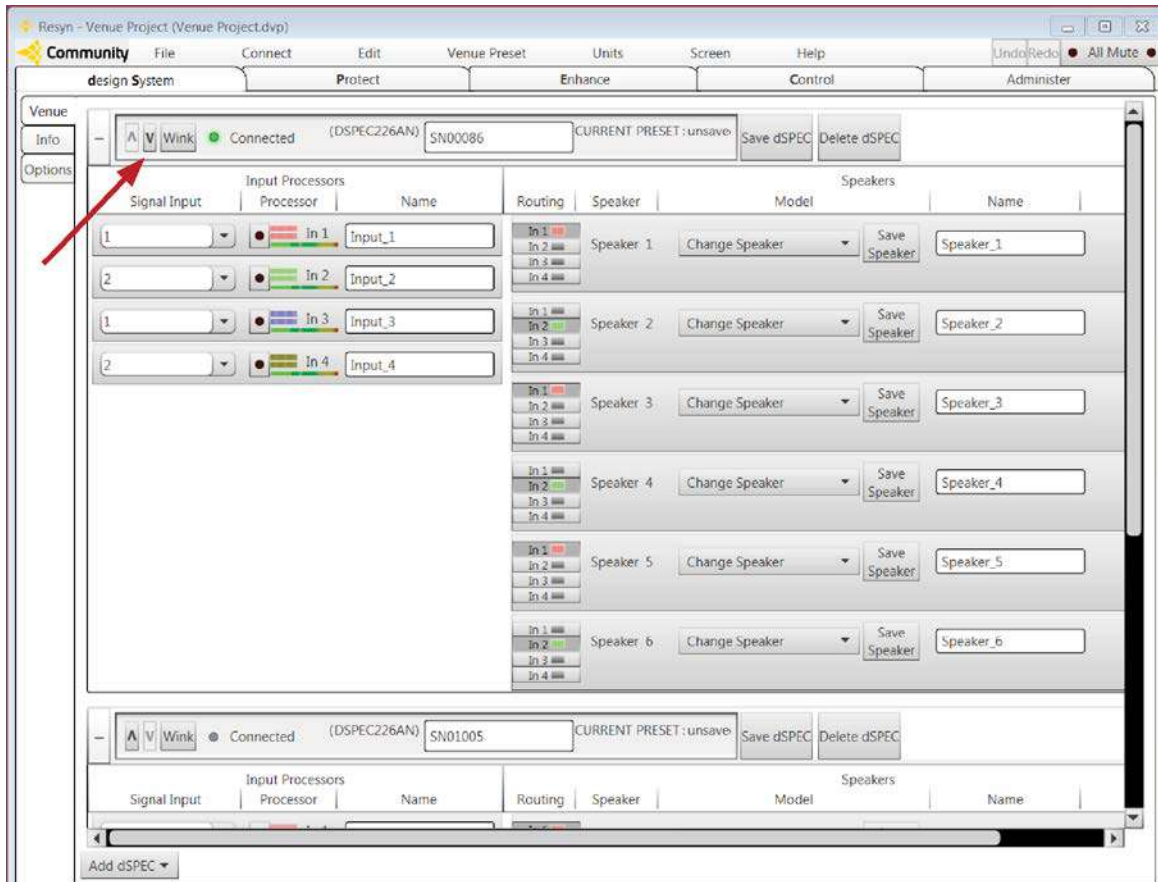

Mute commands, level meters, the signal generator, and new UP and DOWN buttons for re-ordering virtual dSPECS are now all available on the design System screen (see below):

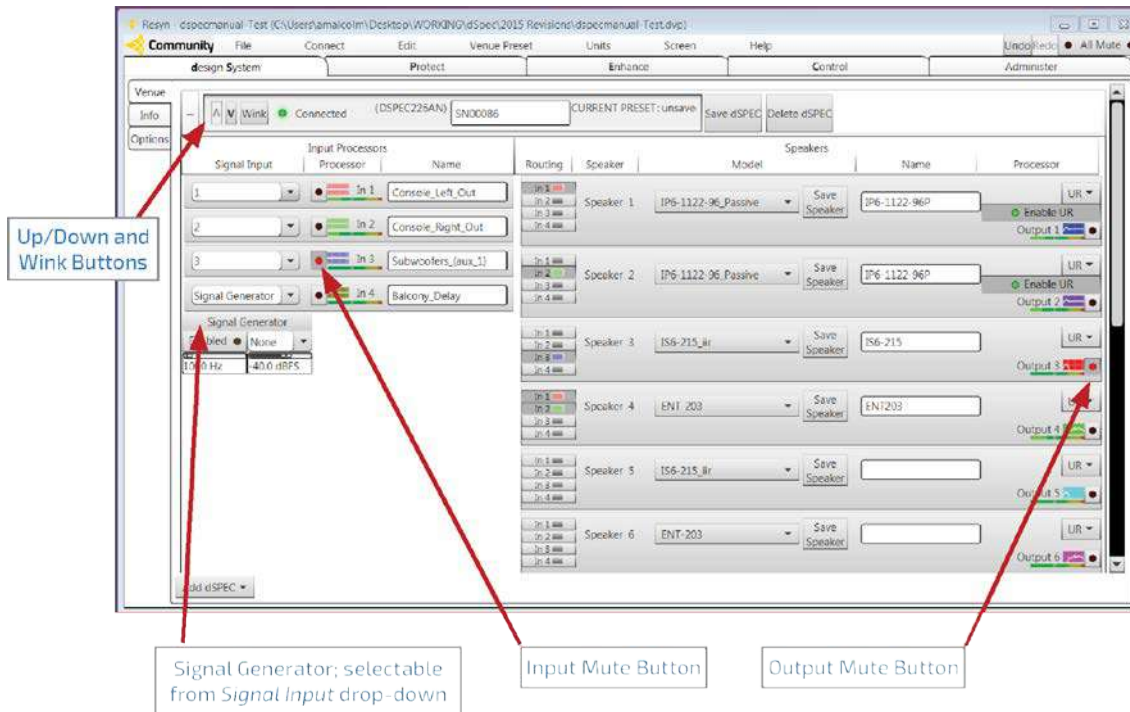

The **red** arrows call attention to the UP and DOWN buttons that allow you to re-order the virtual dSPECS so that they match the physical layout of the dSPEC hardware units in the rack. Adjacent to the UP and DOWN buttons is a **Wink** button so that you can easily identify which dSPEC is which. When clicking on **Wink** all LEDs on the front panel will flash three times in rapid succession, to identify the dSPEC unit that is being addressed.



Switching to **Info** will bring up a new screen that provides a "Note Pad" where you can name the **Project**, the **Location**, the **Status**, the **Author**, and enter any **Comments** you may have that might help you revise system settings, or remind you of why you made certain configuration choices, at a later time. You can also write the sequel to "War and Peace" in the Comment field... if you feel so inclined.

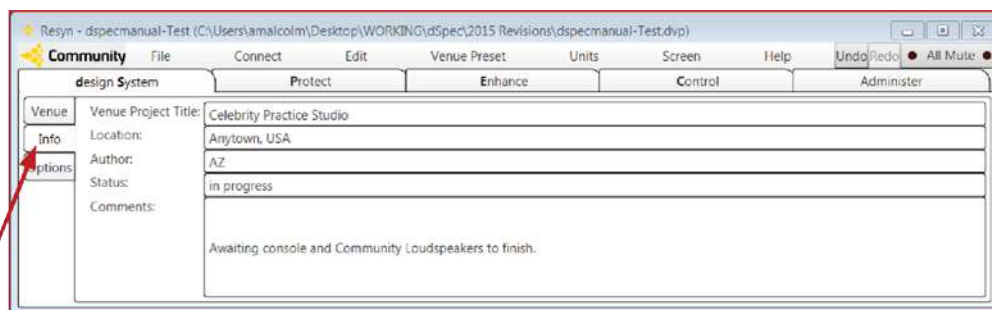

IMPORTANT! The notepad information will be saved to disk file with the Venue Project but nowhere else! *Make sure to save your Venue Project, so that you can access this information in the future.*

Next, selecting **Options** allows you to alter the location where the various files that store dSPEC parameters reside on your hard drive. This is accomplished by clicking on the three dots (...) <see **red** arrow> that will appear at the right of the various headings such as "Default File Location," "My Speaker Library Location," etc. You then use standard Windows commands to make changes to the file locations. Appendix "A" in this Reference Manual describes the various file types that dSPEC uses to store information, and what each one represents.

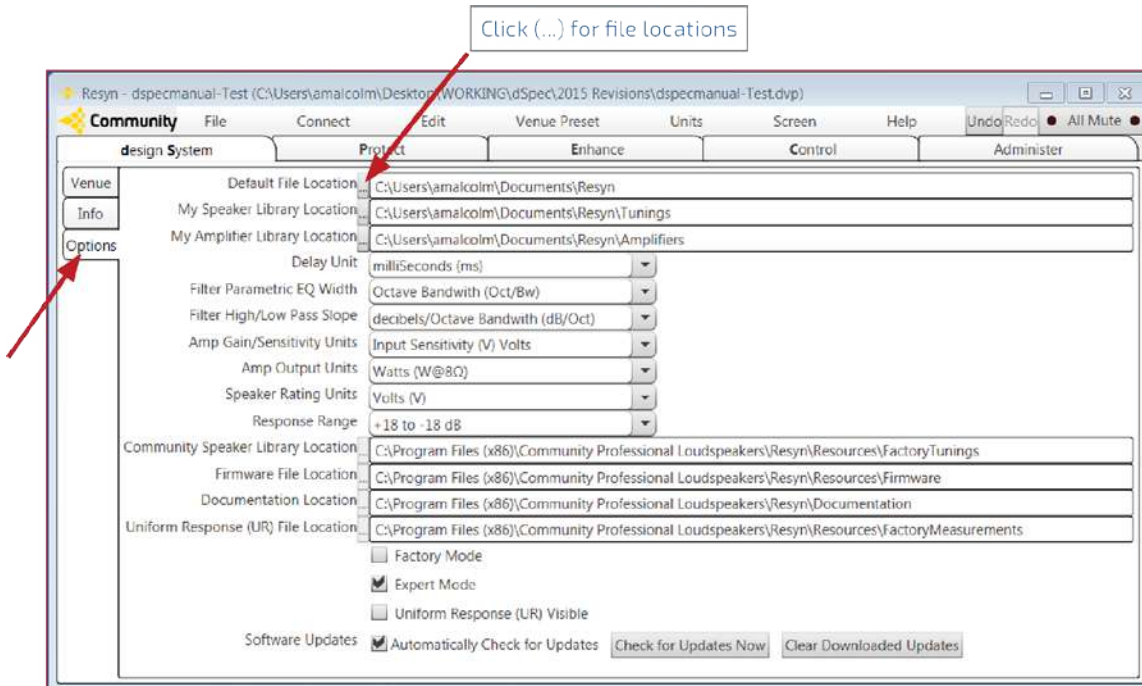

You may copy and paste these file paths by using standard Windows copy shortcuts (Ctrl+C and Ctrl+V) to place them directly into Windows Explorer to access the files in the various folders. This can be extremely useful if you wish to copy some, or all of your files, on a thumb drive, CD-ROM, or other transportable media for archiving, or for use in future installations.

The **Options Tab** also allows you to select the unit measurements that you prefer to use throughout Resyn. It replicates all of the **Options** that are available under **Units** in the Drop-Down Utility Menu that appears in the Task Bar.

Lastly, the **Options Tab** is where you will select **Automatically Check for Updates/ Check for Updates Now**, **Expert Mode**, and **UR Response Visible**. Each of these Options are selected by ticking the enable box, or disabled by de-selecting the tick box.

As discussed above, **Expert Mode** enables the use of two additional file types for advanced applications, as well as the option to view the effect of the UR response curves on the **Enhance** Screen graphic displays.



Input Section

Go back to **Venue** by clicking on the **Venue sub-tab** in the **design System** main tab. At the left side of the screen you'll see the Input section. Each Input defaults with text that reads, **Input 1 Untitled**, **Input 2 Untitled**, and so on. This prompts you to overwrite the default text with nomenclature that's meaningful to your project. For instance, you can name **Input 1** "Main Console Output," or "Console Left Out." Simply place your cursor over the default text and replace the text with whatever you want. You can even leave part of the default label intact (for example: Input 1), and then add your specific description to the left and/or the right side of the default text, which might end up looking like this: Console L - Input 1 – Main Array Left. The text boxes will actually hold many more characters than they can display. You can scroll within each text box by using the left and right arrow keys on your keyboard to reveal text that is too long to display within the box (note: this same labeling procedure applies to text boxes in the other sections as well). Below is an example of an *Input Section* that has already been labeled:

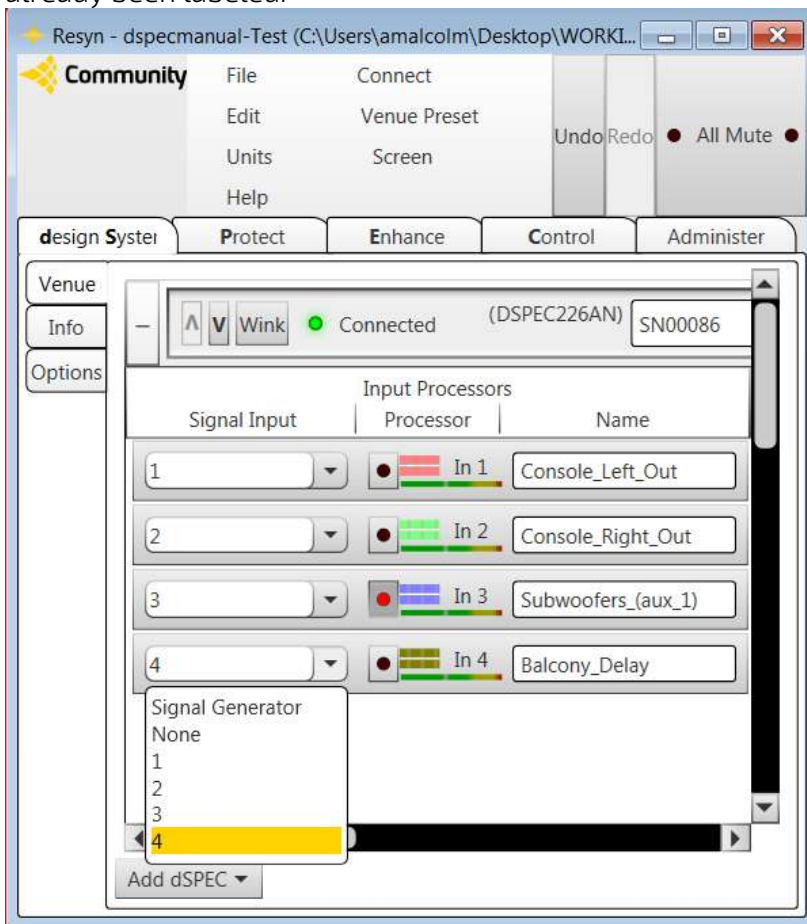

Input level METERS, Input MUTES and the Signal Generator can now be accessed from the Signal Input drop down box.

Notice that when the size of a Window has been narrowed horizontally, as in the example shown above, the **Task Bar** does not disappear; it merely reconfigures itself. All the important commands are still accessible including **Undo**, **Redo**, and **All Mute**.



Next, route each of the *Signal Inputs* to one or more of the DSP *Input Processors*. Use the drop-down boxes associated with each *Input Processor* as depicted in the following example:

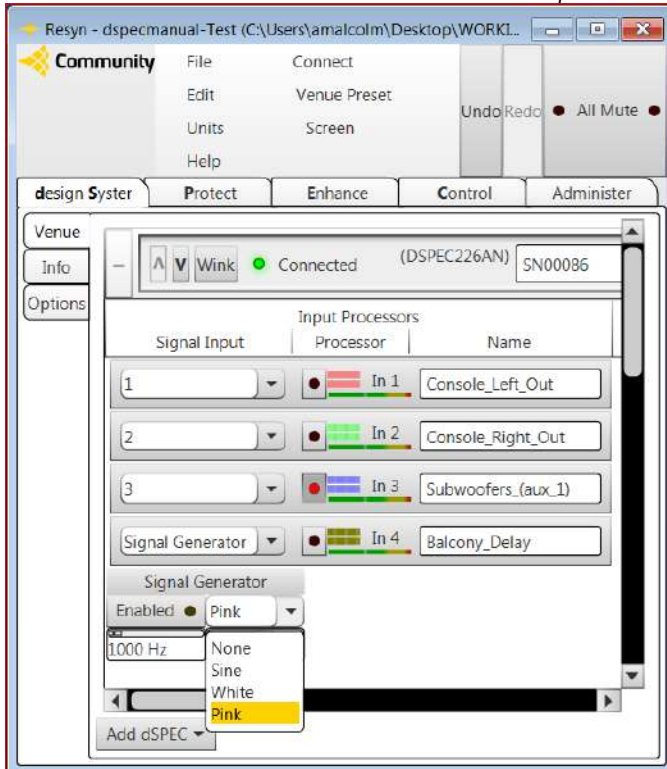

Any *Signal Input* can be routed to more than one of the 4 *Input Processors*. This *routing* feature functions much like a digital patch-bay, but please note that you *cannot sum* multiple *Signal Inputs* to a single *Input Processor*. However, you *can sum* *Input Processors* later in the signal chain to a single *Speaker*, which will be described later.

In the example shown above, Input Number 4 has been selected to access the internal Signal Generator. The Signal Generator control boxes appear on the Input screen whenever any of the Inputs have been set to select it. The Signal Generator options are **None**, **Sine**, **White** and **Pink**. Whenever **Sine** is selected, the frequency of the sinusoidal wave is user-selectable. With *any* selected source the Output level is adjustable from 0.0dBFS to -96.0dBFS. Be sure to be careful with high signal generator levels, as they can easily damage loudspeakers, especially smaller models.



Speaker Section

To the right of the Input Section is the Speaker Section. When you first execute the **Add dSPEC** command by clicking on the **Add dSPEC** button, the default screen will show Speaker 1, Speaker 2, Speaker 3, Speaker 4, Speaker 5, and Speaker 6. These may change later, depending on whether you select single-amped, biamped, or other formats that will eventually occupy the 6 **Output Processors**. dSPEC's 6 **Output Processors** can support 6 single-amped Speakers, 3 biamped Speakers, 2 tri-amped Speakers, or any other combination - up to its inherent limit of six simultaneous **Output Processors**.

Let's now take a look at the four routing buttons associated with each **Speaker**. Note that they match the colors of the 4 **Input Processors**. These buttons assign **Input Processors** to the six internal DSP **Output Processors** that make up the Speaker and Output section, and here is where you can sum **Input Processors** together to drive one or more **Output Processors**, if so desired.

Unlike other DSP loudspeaker processors, dSPEC is oriented in terms of **Speakers**, rather than **Outputs**. This makes it far easier to configure a system, because the work of assigning outputs, crossover points and slopes, EQ, incremental driver-alignment delay, and protective limiters is instantly accomplished by simply choosing the proper model of Community loudspeaker from the **Change Speaker** menu, as illustrated below:

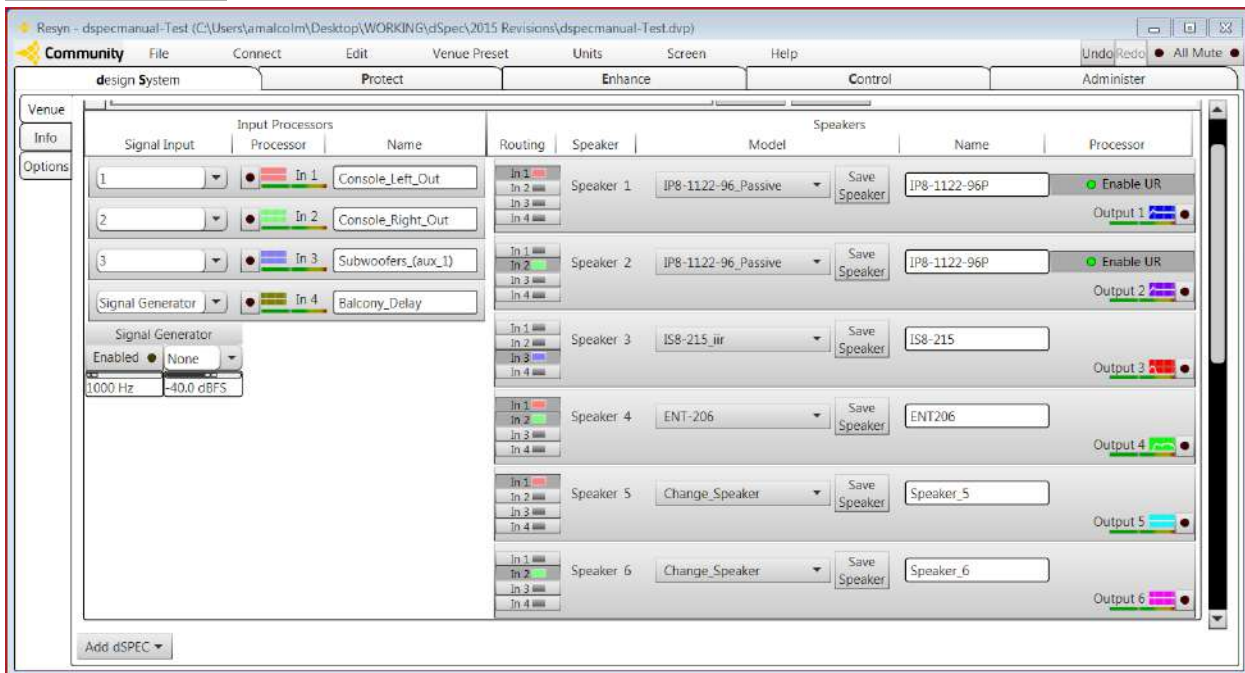

In the example shown above, **Speaker 1** and **Speaker 2** have been selected from the drop-down menu to each be a Community iHP1296H and are routed, respectively, to **Input 1** and **Input 2** simply by selecting the **In 1** button and **In 2** button. Note that to the right side of the screen, UR is in the Enable mode, indicated by the green LED and depicted by the small graph at the far right side of the screen.

The reason that Uniform Response is in the enable mode is because when the **Speaker 1** and **Speaker 2** selections were made, **"UR FIR Filters (preferred)"** were selected from the menu. An alternate choice would have been **"Traditional IIR Filters."** We recommend that you start with the UR FIR Filters; you can always switch back to the traditional filters if you choose to, or you can simply turn the UR correction **OFF** by clicking the **Enable UR** button on the right. Clicking **Enable UR** will toggle between **UR ON** and **UR OFF**, so that you can experience the difference in sound quality.

Also, note that **In 2**, which in this example is labeled CONSOLE RIGHT OUT, the Signal Generator has been selected instead of Signal Input 2. The Signal Generator provides a quick means of testing connectivity and listening to the loudspeakers in the system to ensure that they are properly circuited.

IMPORTANT! Be very careful when activating the Signal Generator. White Noise, Pink Noise, and especially fixed Sine Waves can all cause serious damage to your loudspeakers, if the level of the Signal Generator is high enough.

Note: You can Copy and Paste any Speaker model to another **Output Processor**, or to another dSPEC within a Venue Project. When using multiple dSPECs, this feature saves the extra time that it would otherwise take to locate the Speaker model in the library, save the file, and then re-load it to another dSPEC.

In this example, **Speaker 3** is a Community IS8-215 subwoofer routed to **In 3**, an Aux send from the console. Many mixing engineers and system designers like to feed their subwoofers from an Aux send, rather than the Main Outputs of the mixing desk. However, if it is preferable to feed the subwoofers from the sum of the LEFT CONSOLE and RIGHT CONSOLE Outputs rather than from an Aux send, all you need to do is click *on* the **In 1** and **In 2** buttons, and click *off* the **In 3** box. That would automatically sum the CONSOLE LEFT and CONSOLE RIGHT Outputs into the subwoofer's *Output Processor*.

Speaker 4, in this example, is a group of single-amped Community ENTASYS-206s being used as delay-fill in the upper balcony area. They are being fed from the summed signal of the LEFT CONSOLE and RIGHT CONSOLE Outputs. Once again, all the hard work is done for you. You need only to set the proper delay time for the balcony speakers, establish volume levels for each zone, and adjust EQ to compensate for room effects (if desired), and the system will be ready to use.



Change Speaker allows you to choose from a library that includes **Community Speakers**, **Generic Speakers**, and **My Speakers**. Simply click on the **Change Speaker** button and these three sub-menus will appear. After you've made your selection, some of the text boxes will be filled-in for you. If you've chosen a **Community Speaker**, the model name of the Speaker will automatically appear along with the driver information. Conversely, if you select from **Generic Speakers**, you'll be prompted to enter a name that you want to call the Speaker in the text box.

If you select from **My Speakers**, the relevant text boxes will be filled in with any information that has previously been saved in your custom speaker library. In all three cases, you can change the names in the text boxes – just like you can in the Input section – and the naming will automatically migrate to the other Screens, such as Enhance. Saving is accomplished by executing any of the **Save Speaker**, **Save dSPEC**, or **Save Venue** commands.



If you're *not* using Community loudspeakers in your system, you will choose instead from **Generic Speakers**. The library includes *full-range, biamped, tri-amped, quad-amped, pent-amp, and hex-amp* configurations. Here again, the Outputs will automatically be assigned for you, but unlike selecting a Community loudspeaker model, you will still have some work to do.

With non-Community Speakers you will need to set the low-pass and high-pass filters, the crossover points, crossover rates and types, incremental delay to align drivers (if any), as well as establishing the settings for driver protection in the **Protection Screen**. But thanks to dSPEC and Resyn's straightforward design, these tasks are made easy. We recommend that you utilize a high-resolution audio spectrum analyzer to aid in establishing these settings.

IMPORTANT! It's a good idea to save the parameters you've established in **My Speakers** by clicking on **Save Speaker**, so that your Speaker configurations –called *Tunings* in the file system - can be accessed for future use if you might wish to load that same Speaker file by itself in the future.



Uniform Response

As we mentioned in the Introduction, Uniform Response is a technology that we use in order to bring you the very best in leading-edge sound reinforcement. Uniform Response provides **1024 points of equalization** that precisely flattens the response of each Community loudspeaker in the **UR FIR Filters (Preferred)** section of Resyn's Speaker library¹. There's no other technology like it in the world, and Community is the first to incorporate Uniform Response into a loudspeaker controller. The improvement in sound quality is exceptional!

You do not need to *activate* the Uniform Response feature. Whenever you choose a Community loudspeaker from the **UR FIR Filters (Preferred)** Community Speaker Library, the associated Uniform Response correction will automatically be engaged. You may instead select from the **Traditional IIR Filters** library, if you want to match a given loudspeaker's voicing to that which was established in the pre-Uniform Response era. Most speakers have both kinds of filters available, but some have only Uniform Response while others, especially sub woofers, have only **Traditional IIR filters**. This is because the Uniform Response correction is linear in frequency rather than logarithmic, and is therefore not as high in resolution at very low frequencies, so it's less effective for subwoofers.

Please note that the advanced Uniform Response corrections provided in dSPEC are only available for Community loudspeakers. You cannot use Uniform Response with any other brands or types. This is due to the complexity of gathering the initial measurement data, which is performed in our laboratory environment.

If you wish to *hear* exactly what Uniform Response is doing to improve the sound quality, you can toggle the **UR** correction **ON** and **OFF** by clicking on the **Enable UR** button on the right side of the design **System** screen. The small round 'LED' indicator will change from green (*enabled*) to black (*disabled*).

Likewise, if you wish to *see* what Uniform Response is doing, you can enable the **Expert Mode** of operation. This is easily accomplished by selecting **Options** under the design **System** screen, and then

¹ Some Community loudspeakers in Resyn's library are not available with Uniform Response corrections.

ticking the check box named **Expert Mode** and also ticking the check box named **UR Response Visible**. You will then be able to see the corrective response curve that Uniform Response has introduced into the signal path.

Keep in mind that what you'll be seeing is the *correction response curve*, rather than the result of the correction. The corrected loudspeaker is essentially flat (throughout its operating range) and while that is a good thing, there is not much useful information to be obtained by viewing a straight line.

Conversely, viewing the Uniform Response correction curve can sometimes be helpful when applying additional EQ to correct for room response variations. Note that all user-adjustable IIR filters remain accessible whether Uniform Response is **IN** or **OUT** of the signal path. Uniform Response does not use any overhead from the DSP but rather, from an internal FPGA which is dedicated entirely to the Uniform Response correction process. Because Uniform Response flattens the power response of the loudspeaker, the effect of using IIR filters may become more pronounced than expected.

WHAT'S THE DIFFERENCE BETWEEN IIR AND FIR FILTERS?

IIR filters (Infinite Impulse Response) have been used in audio systems for more than 75 years. Originally built with passive resistors, capacitors, and inductors, they are now implemented with active analog components - or modeled within DSP chips. Whenever an IIR filter is used to adjust frequency response, a corresponding alteration will occur in phase response. This is not necessarily a bad thing, as it can be shown that if the response correction is optimally compensating for room resonance, the resultant phase response will always improve.

FIR filters (Finite Impulse Response) are achievable only by use of digital processing. Describing FIR all types of FIR filters available is beyond the scope of this manual. In professional audio, two types of FIR filter are generally encountered; Linear Phase and Minimum Phase.

Linear Phase FIR filters are capable of making changes in frequency response without any corresponding alteration to the phase response, but the price to pay is an increase in signal latency (latency is the time it takes for a signal to propagate from the input to the output of a given device). At low frequencies with large numbers of filters, the delays can add up to seconds of latency.

Minimum Phase FIR filters act very similarly to IIR filters, which are also a type of Minimum Phase filter. An adjustment to the frequency response will result in a corresponding change to the phase response. The advantage of Minimum Phase FIR filters vs. Linear Phase FIR filters is that they have no additional latency. Thousands of points of Minimum Phase FIR filters can be applied with very little added latency; they have the same latency, due to simple phase shift, as IIR filters. Thousands of Minimum Phase FIR filters can easily be added to an audio processor while using a fraction of the resources needed to add the same number of IIR filters.

Uniform Response corrections use Minimum Phase FIR filters. They minimize latency and create an extremely detailed loudspeaker correction curve while leaving system resources free for other DSP processing functions.

When you're EQ'ing your sound system to optimize its performance in relation to room acoustics, it may become confusing to view the Uniform Response correction *and* the elective EQ that you are introducing into the signal path. If the view on the screen is too distracting with **UR Response Visible** enabled, it's a simple matter to return to the **design System** screen and un-check the **UR Response Visible** tick box. A screen capture of a typical Uniform Response correction follows:

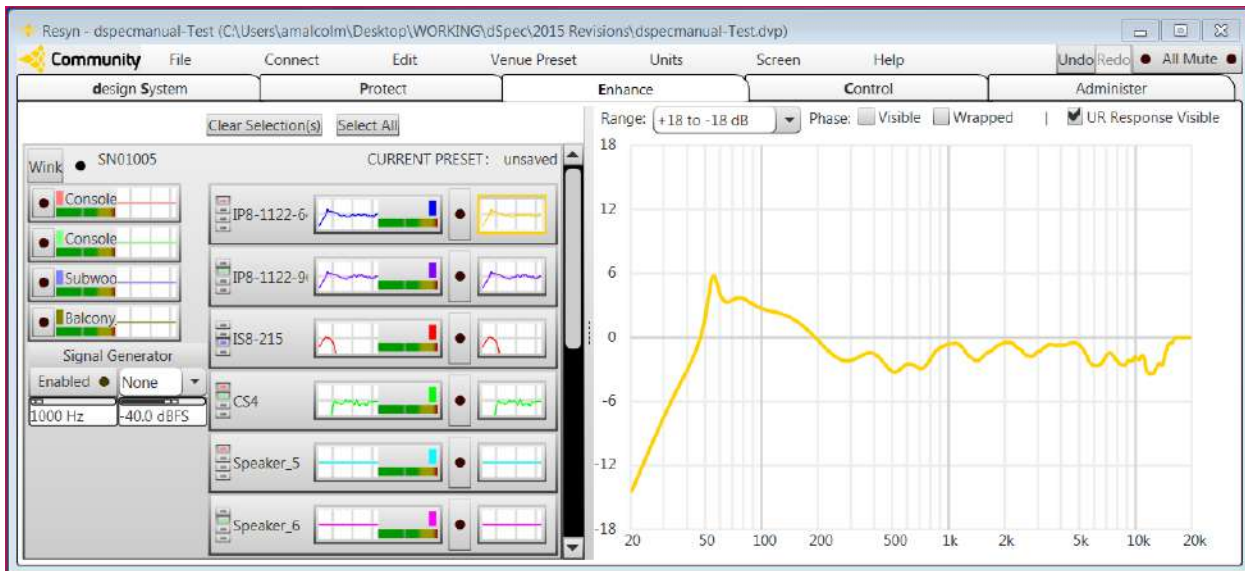

As you can readily see, there are significant corrections to the loudspeaker's response that have been introduced by Uniform Response. However, it's important to note that Uniform Response measurements are based on **Acoustic Power Frequency Response**, *not* a typical **SPL response**, which is why the Uniform Response correction curve might appear to be overly EQ'd.

Acoustic Power refers to the entire sound field of the loudspeaker, not just one - or even a few - specific measurement points. Therefore, while the correction might seem somewhat radical it's definitely not, when the nature of Uniform Response's unique measuring process is fully appreciated. Also, please note that the Uniform Response correction trace actually represents the inverted response of the **UR** correction filters. When these filters are applied to the loudspeaker, the net effect is that of flattening the acoustic power response anomalies.

Below is a **UR** screen capture that shows the original response of a loudspeaker (the green trace); the EQ filters that **UR** has generated are depicted in an inverted (upside) format display (the yellow trace); and the final result - which is an almost perfectly flat response (the orange trace):

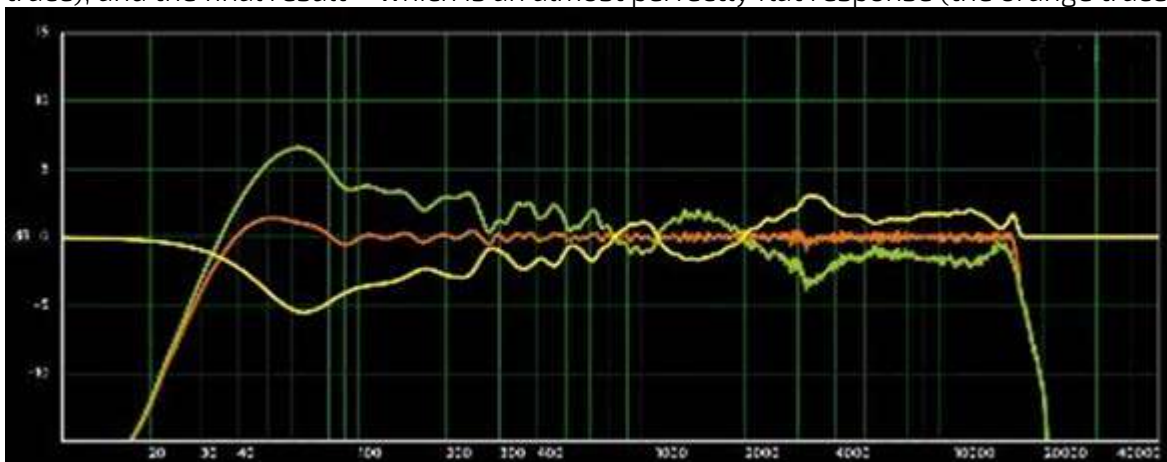

● Protect Screen Tab

Clicking on the **Protect** Tab brings up the **Protect** Screen. If you've chosen a **Community** loudspeaker in the **design System** screen (rather than a generic loudspeaker), each driver's power handling parameters will populate the appropriate sections of the **Protect** screen automatically, as in the example shown below. In this first example we've truncated the screen to display only one *Output Processor*, in order to improve readability:

The screenshot displays the 'Protect' screen for a 'Community' loudspeaker system. The interface includes a menu bar with options like 'File', 'Connect', 'Edit', 'Venue Preset', 'Units', 'Screen', 'Help', 'Undo/Redo', and 'All Mute'. Below the menu is a tabbed interface with 'design System', 'Protect', 'Enhance', 'Control', and 'Administer' tabs. The 'Protect' tab is active, showing a 'Wink' status and a connected device '(DSPEC226AN) SN01005'. The main area is divided into sections for 'Amp Ratings' and 'Driver Ratings'. The 'Amp Ratings' section includes a 'Change Amp' dropdown, 'Save Amp', 'Measure', 'Notes', 'Test', 'Input Sensitivity' (0.77 V), and 'Output' (0 W@8Ω). A red box highlights the 'Output' field, and a red arrow points to it. Below this, a red text warning states: '** 1596W@8Ω amp recommended for max output.' The 'Driver Ratings' section shows 'Driver Type' set to 'Low Impedance' and a table of ratings:

Impedance	Peak	Program	RMS
8.0 ohms	160.0 V	113.1 V	80.0 V

Red arrows point to the '8.0 ohms', '160.0 V', '113.1 V', and '80.0 V' values in the table. Below the table is an 'Apply Amp + Driver Ratings' button. The 'Limiter Settings' section includes a table with columns for 'Peak', 'Program', and 'RMS' and rows for 'Threshold', 'Attack', 'Release', and 'Ratio':

	Peak	Program	RMS
Threshold	20.0 dBu	20.0 dBu	20.0 dBu
Attack	1 ms	30 ms	1000 ms
Release	5 ms	200 ms	2000 ms
Ratio	20	20	20

Next, notice that the full screen is divided into six sections that correspond to each of the six DSP *Output Processors* (note: for this example we've again truncated the screen to only three *Output Processors* for better readability).

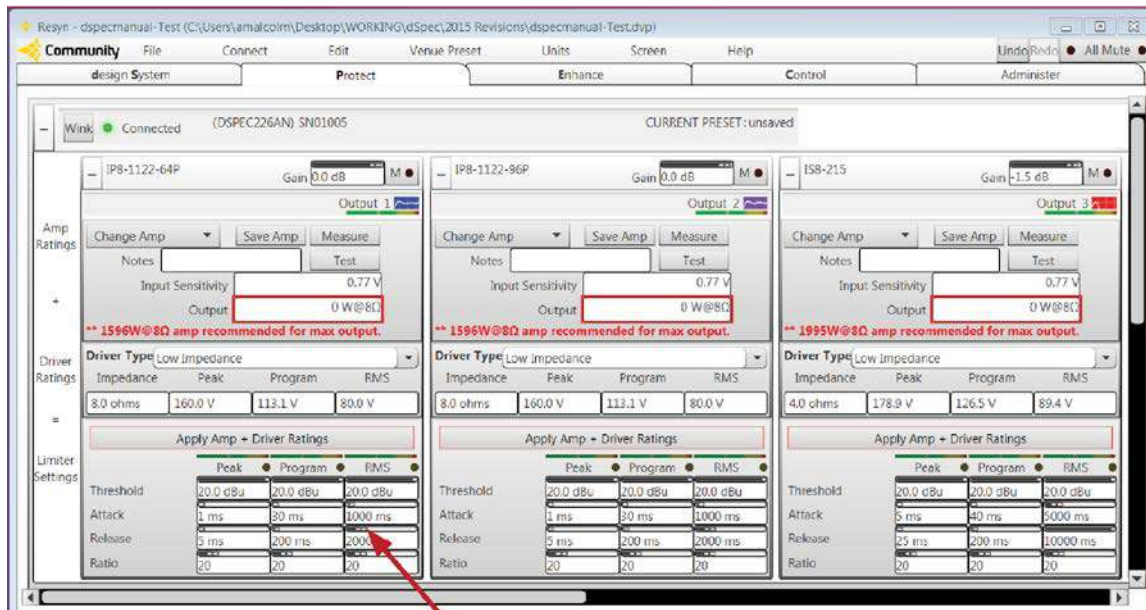

(for non-Community models) Move Sliders or enter appropriate values in boxes

The screen is now laid out to explicitly show Amplifier Ratings + Driver Ratings = Limiter settings. More additions and improvements include:

- Support for 70V, 100V, and 140V constant voltage transformer driven speakers.
- Additional "units" selection for Amp Output Watts at 4, 8, 12, or 16 ohms.
- New color plots to identify channels and clarify screen layout.
- New signal generator view.
- New speaker volume, mute, and level meters.
- Output level meters are now relative to full scale instead of to limiter threshold.
- Limiter attenuation meters are now viewable (but only in Expert mode).

As mentioned above, selecting a Community Speaker from the library will automatically populate the Amp, Driver, and Limiter boxes with the proper settings. However, if you're using **non-Community loudspeakers**, you can enter each driver's power-handling specifications manually by simply increasing or decreasing the numerical value of the settings by dragging the cursor left and right – or up and down. Alternately, you can overwrite the existing numerical value with a new value, by first clicking on the value you wish to change, and then using the numeric keys on your keyboard to enter a new value.



The **Protect** screen is where you'll enter the name, model, and type of amplifiers in the system, along with each amplifier's *Input Sensitivity* or its *Gain* (dSPEC accepts either), and the amplifier's *Output Power* ratings.

Better yet (and highly recommended), you can use dSPEC's unique "AMP CAL IN" Port to accurately measure each amplifier channel - instead of manually entering the manufacturer's ratings. We'll explain how to do this in just a moment.

Working with Protective Limiting for Non-Community Loudspeakers

If you are using non-Community loudspeakers, you'll need to determine the parameters of each loudspeaker yourself. These include impedance and power handling for each driver in a bi-amplified or tri-amplified system, or overall power handling in a single-amped system. You'll enter these values manually in the Driver Ratings boxes.

First, click on the **Edit** box in the Driver Ratings section of the **Protect** Screen to enable the values to be altered. Next, enter the impedance of the drivers in your system, and the power-handling ratings in your selected units (Volts, Watts or dBu) into the Driver Ratings text boxes. To calculate the Voltage for a given Wattage rating you simply find the Square Root of the Impedance times the Wattage. For example: a 200 watt 8 ohm driver would be $200 \text{ (watts)} \times 8 \text{ (ohms)} = 1,600$. The Square Root of 1,600 is 40 (volts). Calculating the maximum voltage of each driver in your system is a good place to start when setting limiter thresholds, though you may wish to be conservative by starting at an even lower threshold, to be sure that your driver(s) are adequately protected.

While the mathematical relationship of Voltage, Watts and Impedance is useful to know, if you don't have a calculator handy - or don't feel inclined to use it - *Resyn will perform the calculations for you*. Simply click on **Speaker Ratings** under the **Units** drop-down menu on the **Task Bar**. There you can select dBu, Volts, or Watts, and the values in the "**Driver Ratings**" text boxes on the **Protect** Screen will immediately change and be automatically relabeled with the newly chosen units. Note that changing **Units** does not change any of the operating parameters, only the resultant display. Because Resyn uses the driver impedance when converting between Volts and Watts, *it is important to enter the Impedance first before changing units*. Otherwise, there is no load-basis to on which to recalculate the remaining parameters.

Next, you will set the time constants of the three stages of limiters. The default values for the *Attack* time are 1ms for the fast-acting Peak limiter, 30ms for the mid-term Program limiter, and 10,000ms for the long-term RMS limiter. Default values for the *Release* time are 5ms, 120ms and 1000ms respectively. The limiter *Ratios* default to 100:1, but can be set anywhere between 1:1 and 100:1. If you are using Community Loudspeakers, the optimal settings will have already been automatically entered for you. When using non-Community loudspeakers the default values represent a good starting point, but may not be appropriate for all driver type and models.

More about Protection

dSPEC is unique in that it offers *three* levels of dynamic loudspeaker protection, each level functioning compatibly with the others. Our proprietary protection algorithms take into account the **Peak** voltage level, the **Program** voltage level, and the **RMS** voltage level individually, for each loudspeaker model in the supplied library, and for *each driver* in a multi-amplified (biamped or tri-amped) system.

We provide different thresholds for the three limiter stages, as well as different time constants. The **Peak limiter** typically uses a very short attack and release time - intended to avoid amplifier clipping - while also protecting the drivers from potentially damaging short-term events such as a dropped microphone, an unplugged cable, or a sudden occurrence of feedback.

The **Program limiter** protects the loudspeaker from excessive transient signals during normal audio playback, while the **RMS limiter** protects the drivers from thermal damage due to running the speakers very close to, or above, their maximum power handling for extended periods of time. The **RMS limiter** is especially useful at providing protection when highly compressed signals are present, such as in some electronic and pop music. Working together, these three types of limiters offer significantly better protection, with less audible artifacts, than any single form of limiting could provide alone.

In biamplified, tri-amplified or other multi-amplified systems, each of the three stages of limiters described above can be individually optimized for *each individual output band*. This is important because the optimal time constants and thresholds for a delicate high frequency compression driver are very different than for that of a low frequency cone driver.

IMPORTANT! After establishing your settings in Protect, make sure to click on the box labeled **Apply Amp + Speaker Ratings**. It will be framed with a slowly flashing red outline to help remind you to click on it before moving on to other work (see the example below). Once the settings have been applied, the flashing **red border** will disappear.

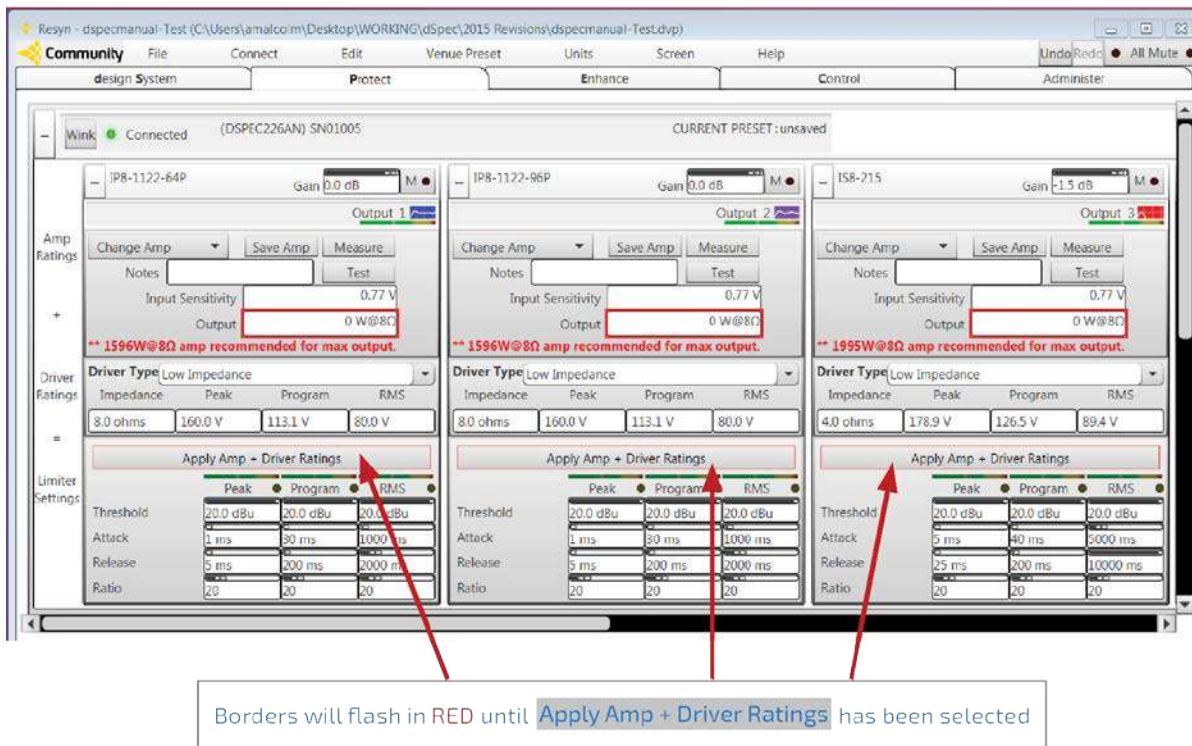

AMP CAL

A unique feature of dSPEC is its ability to automatically measure and then calibrate the dynamic characteristics of every amplifier in the system. This feature enables the protective limiters to precisely engage when they're needed, thereby avoiding damage to the loudspeakers - but without prematurely "squashing" the sonic quality from overly aggressive protection levels.

With other DSP based loudspeaker controllers it's 'hit and miss' to derive the ideal protection parameters. Of course you could destructively test numerous drivers as a step to establishing the proper protection settings, but we don't think that's desirable.

How AMP CAL Works

Rather than wondering if your protection settings will be effective until it's too late, dSPEC allows you to temporarily connect the output of each amplifier in the system to the "AMP CAL IN" port on dSPEC's rear panel. Then, when you activate the measurement **Wizard** by clicking on the **Measure** button, you accomplish two things: first, dSPEC accurately measures the loop gain of the amplifier to ensure that the protective limiters will engage at the proper level.

Second, by comparing the amplifier's input level to its output – as the gain of the test signal is steadily increased during the automatic measurement procedure – dSPEC determines the point at which the amplifier can no longer increase its output voltage in linear proportion to its input signal, and thus has reached the onset of distortion. By running the AMP CAL measurement **Wizard**, dSPEC precisely calculates the optimal settings that best protect each loudspeaker from damage, while keeping each amplifier in the system from clipping - which will cause excessive distortion and potential driver damage.

One Caveat: because dSPEC's AMP CAL function measures each amplifier channel until the onset of distortion, it *may* measure a class G or class H amp as being lower than the manufacturer's rating. This is because these amplifier topologies often exhibit distortion at the first rail switchover. If this proves to be the case, you can enter the manufacturer's power ratings from the numbers on your amplifier's spec sheet instead of using AMP CAL.

IMPORTANT! The maximum permissible output voltage from an amplifier connected to the "AMP CAL IN" port is 150 VRMS (this equates to 5,625 Watts into a 4 ohm load). If you are using amplifiers in your system that are *more* powerful than 5,625 Watts into 4 ohms, we recommend that you *manually* enter the amplifier's Input Sensitivity and Output Wattage ratings. dSPEC will not be harmed by connecting an amplifier that delivers more than 150 VRMS to dSPEC's "AMP CAL IN" port, but it will not be able to accurately measure the amplifier's clipping level.



WARNING! Do NOT run Measure with a loudspeaker connected to the amplifier! The loudspeaker will almost certainly be damaged, as dSPEC intentionally pushes the amplifier well past its nominal rating, in order to determine the onset of distortion.

Using Class D Amplifiers with dSPEC's AMP CAL

Class D amplifiers employ switching output stages (and often switching power supplies), as opposed to the traditional linear power supplies and linear output circuits that are used in Class A, Class A/B, and other non-switching amplifier designs. Some Class D models are hybrids, employing a switching power supply with a linear amplification stage. Others are designed with linear power supplies and switching output stages, while still others utilize switching power supplies *and* switching output stages. The primary advantage of amplifiers that employ switching systems is that the size and weight of the finished product is typically reduced in respect to 'traditional' linear amplifiers - and sometimes the cost is reduced as well.

Because Class D amplifiers typically do not store large reserves of power in big banks of capacitors, power measurements must be acquired differently than for linear amplifiers in order to obtain meaningful results. Resyn therefore lets you select the type of amplifier that you're measuring. The selection screen shown below will appear before Resyn allows you to execute an "AMP CAL" measurement:

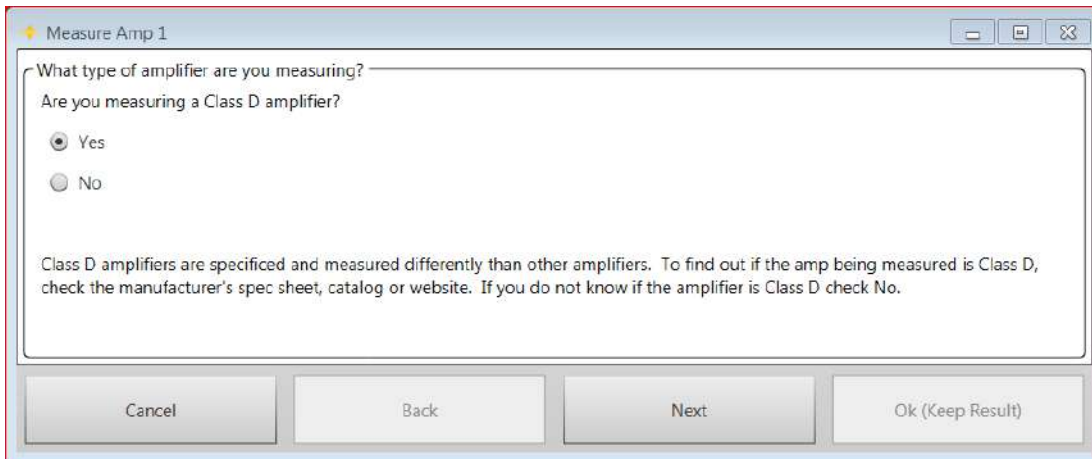

After you choose **Are you measuring a Class D amplifier? Yes / No** Resyn will walk you through the next simple steps. Resyn also provides some important warnings (*mainly, disconnect your speaker before running the AMP CAL measurement routine!*), and will also display connectivity diagrams as shown below:

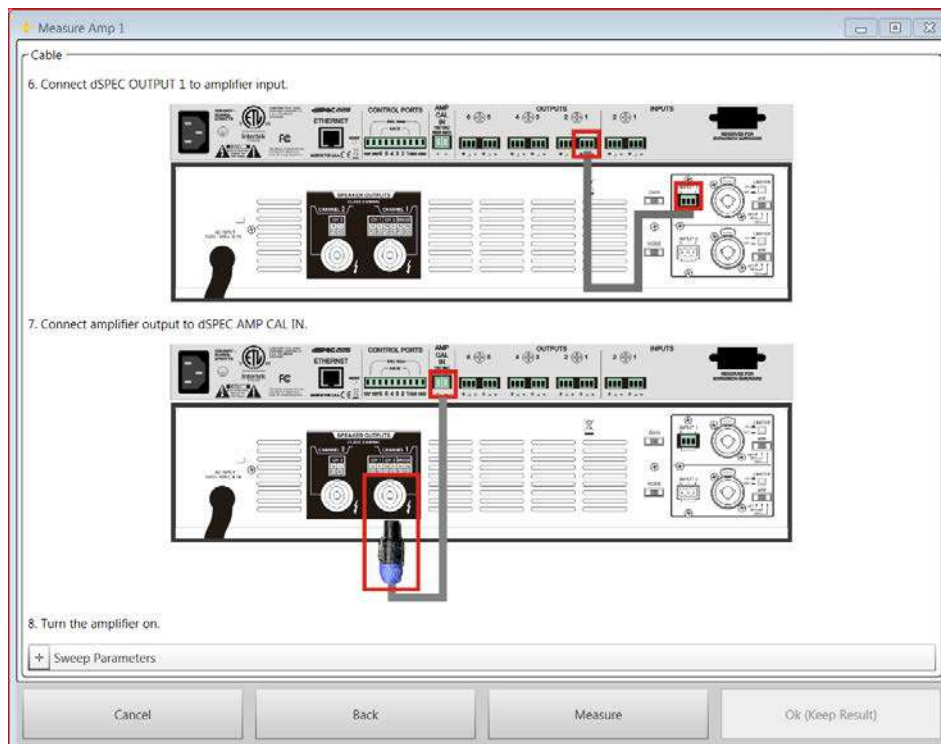

Making an AMP CAL Measurement

To make an AMP CAL measurement you must have dSPEC hardware connected to your computer. If no physical dSPEC is available, the **Measure** button will be grayed-out and will not respond. This is because the dSPEC hardware is an integral part of the Measurement process. This is one setup process that *cannot* be done offline.

You start by connecting one channel of an amplifier in your system to dSPEC's **AMP CAL IN** port. This will be a temporary connection only. You then connect the appropriate dSPEC *Signal Output* to the Input of the amplifier. Next, you click on **Measure**. A series of screens will appear that guide you through the process. The first screen is shown below:

Measure Amp 1

Prepare Amplifier

1. Disconnect all speakers from amplifier connected to dSPEC OUTPUT 1.

Failure to disconnect the loudspeakers from amplifiers may result in damage to the loudspeakers. See the Reference Manual for more information.

2. Set mode on amplifier to Stereo, Parallel, or Bridged.
3. Disengage any limiters in amplifier.
4. Set the gain on the amplifier.
5. Set the output controller (volume knob) on the amplifier:

Method	Volume Knob Position	Pros	Cons	Recommended for:
Simple	Maximum (all the way up)	easy and quick requires no prior calculation of system gain structure	reduced signal to noise ratio	Systems where it is inconvenient or impossible to determine the proper gain structure
Optimal	Determined by the gain structure of the system	optimized signal to noise ratio	* requires knowledge of how to determine proper system gain structure can be time consuming to determine proper levels throughout the system	Experienced users with the requisite knowledge of optimizing system gain structure

* Read about Gain Structure:
[Basic System Gain Structure](#)
[Advanced System Gain Structure](#)

Cancel Back Next Ok (Keep Result)

The next screen in the series shows you how to connect dSPEC to the amplifier:

Measure Amp 1

Cable

6. Connect dSPEC OUTPUT 1 to amplifier input.

7. Connect amplifier output to dSPEC AMP CAL IN.

8. Turn the amplifier on.

Sweep Parameters

Cancel Back Measure Ok (Keep Result)

After the wiring is in place, click on the box labeled **Measure** (found towards the bottom-right of the screen – see **red** arrow above). After the short Measurement procedure has been completed, a final screen will appear that displays the results of the procedure.

⚠ CAUTION! DO NOT USE THE AMP CAL FUNCTION WITH A LOUDSPEAKER CONNECTED! THE LOUDSPEAKER WILL ALMOST CERTAINLY BE DAMAGED BY THE EXCESSIVE VOLTAGE AND NATURE OF THE SIGNAL THAT IS USED DURING THE AMP CAL MEASUREMENT PROCESS!



As you can see in the screen shot depicted below, the Measurement routine gathered 43 samples that were used to calculate the amplifier's loop gain, input sensitivity, and available power into a theoretical 4 ohm load. Also, note that the number of samples will vary dependent on the amplifier – there is no set or predetermined number of samples.

Measure Amp 1

Results

9. Click Back to measure again or reconnect speaker to amplifier if measurement is complete.

Is Class D

Input Sensitivity	3.25 dBu	1.13 Vrms	
Gain	30.91 dB		
Max Output	34.16 dBu	39.52 Vrms	

390 W@4Ω
195 W@8Ω
130 W@12Ω
98 W@16Ω

29 Samples

Input	Gain	Output
-3.80 dBu 0.50 Vrms	30.91 dB	27.11 dBu 17.56 Vrms 77 W@4Ω
-9.00 dBu 0.27 Vrms	30.91 dB	21.91 dBu 9.65 Vrms 23 W@4Ω
-9.00 dBu 0.27 Vrms	30.91 dB	21.91 dBu 9.65 Vrms 23 W@4Ω
-8.00 dBu 0.31 Vrms	30.91 dB	22.91 dBu 10.83 Vrms 29 W@4Ω
-8.00 dBu 0.31 Vrms	30.91 dB	22.91 dBu 10.83 Vrms 29 W@4Ω
-9.00 dBu 0.27 Vrms	30.91 dB	21.91 dBu 9.65 Vrms 23 W@4Ω
-9.00 dBu 0.27 Vrms	30.91 dB	21.91 dBu 9.65 Vrms 23 W@4Ω
-6.00 dBu 0.39 Vrms	30.91 dB	24.91 dBu 13.63 Vrms 46 W@4Ω
-6.00 dBu 0.39 Vrms	30.90 dB	24.90 dBu 13.62 Vrms 46 W@4Ω
-3.00 dBu 0.55 Vrms	30.91 dB	27.91 dBu 19.26 Vrms 93 W@4Ω

Cancel Back Next **Ok (Keep Result)**

Click to save Result

By comparing the Input Signal to the Output Signal, dSPEC knows how the amplifier will perform over a wide range of input levels and it sets the protective limiters accordingly. Be sure to click **OK (Keep Result)** at the bottom right of the screen to retain the measurement data (see the **red** arrow in the screen-capture above). The data will then automatically appear in the "Amplifier" section of the

output channel on which the Measurement was initiated. Below is an example of the Measurement data automatically added to Output Channel #1 on the Protect screen Tab for the specific amplifier that was used in this example.

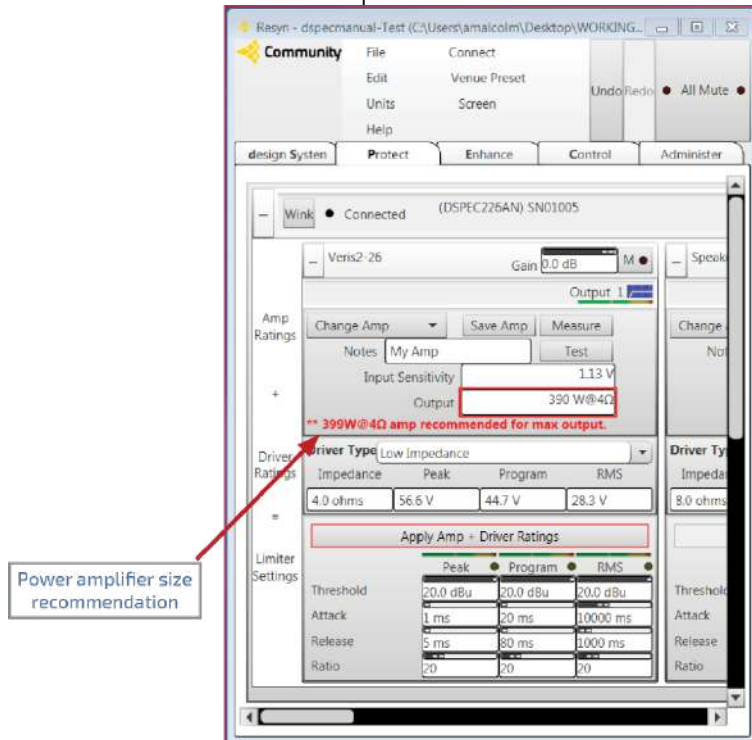

Thresholds, time constants, and limiting ratios can be very difficult to estimate accurately, so it's better to err on the conservative side to avoid driver damage. After you've entered the values you wish to use, you'll see a slowly flashing red border around "Apply Amp + Speaker Ratings."

Clicking on "Apply Amp + Speaker Ratings" will cause the red flashing border to disappear. The *threshold* settings for all three stages of limiters will now have been set to protect the loudspeaker and prevent the amplifier from clipping.

After you've entered all the parameters for Drivers, Limiters, and Amplifiers, clicking on the **Save Amp** button will store the amplifier parameters in the "Amplifier" file directory for later use, thereby avoiding the need to enter the parameters again in the future.

NOTE: if dSPEC calculates that the amplifier rating you've entered is too low to achieve maximum performance from your loudspeaker, it will frame the Output text box with a red border and warn you with a red message such as this one: ****399W@8Ω amp recommended for max output.**

Rolling your cursor over this warning will provide additional instructions for selecting the suggested minimum amplifier power for the speaker parameters that have been entered.



IMPORTANT! At this point in the progression of designing your system, it's recommended to execute a **Save Venue Project** command so that all of the settings and parameters you've established will be stored to disk. Simply click on **File** in the **Task Bar**, and choose **Save Venue Project**. This is especially important if you do not have one or more *actual* dSPECS connected to your computer, as all settings and parameters will be lost if not **Saved**.

REMEMBER, THERE IS NO AUTO-SAVE-TO-DISK FUNCTION!



About Front Panel LED's

Each *Input* is represented by a ladder-array of three LEDs on the front panel (see image below). The lowest LED is **green** in color and indicates *Signal Presence*. It illuminates at -60 dB below Full Scale (-60 dBFS) to indicate that a signal is present on that *Input*. The middle LED is **yellow** and illuminates at -6dB below Full Scale (-6dBFS) note: the **green** LED will also be illuminated.

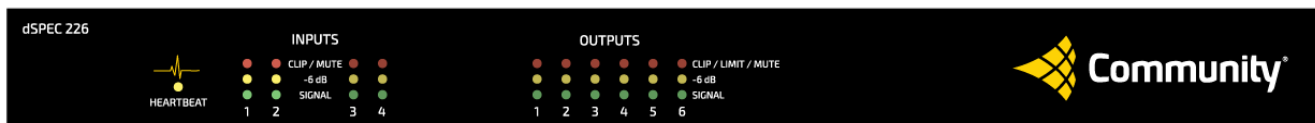

The top **red** LED will illuminate just before *Input Clipping* (-2dBFS). *Input clipping should always be avoided on any digital audio product, as it can cause disturbing audible artifacts.*

The *Output* LED's behave almost the same as the *Input* LED's but with one difference. Whenever protective limiting has been engaged, all three LED's (**green, yellow, red**) will illuminate. This indicates that dSPEC is limiting the output level to the amplifier(s) to avoid loudspeaker damage. Additionally, each **red** LED in both the *Input* and the *Output* sections will turn **solid red** to indicate that a **Mute** command has been executed for that particular *Input* or *Output* channel.



- Enhance Screen Tab

Clicking on the **Enhance** Tab opens the **Enhance** Screen. **Enhance** is where most of the controls and graphic displays reside in Resyn such as *Level, EQ, Delay*, and more. Before using the **Enhance** screen, it's a good idea to have an understanding of how **Enhance** is structured.

Enhance in Resyn is similar to Windows® Explorer. Windows Explorer provides two views of your file system: on the left side is a *folder* view that displays the folders in your file system and on the right side, a *file list* that lists the files that reside in a specific *folder*. When you click on a *folder* on the left side of Explorer, the *files* in that *folder* appear on the right side. This is a well-proven approach to managing multiple elements. Resyn's **Enhance** screen also has two views. The first is the *Navigation View* that allows you to select one *or more* dSPECS, Input Processors, Speakers, Drivers, and dSPEC

overall Outputs. When you click on one of the items in the *Navigation View*, which appears on the **left** side of the screen, a *Detailed View* of that item will appear on the **right** side of the screen – much like in Windows Explorer.

The example below shows how the LEFT MAIN Input is displayed in detail on the **right** side of the screen:

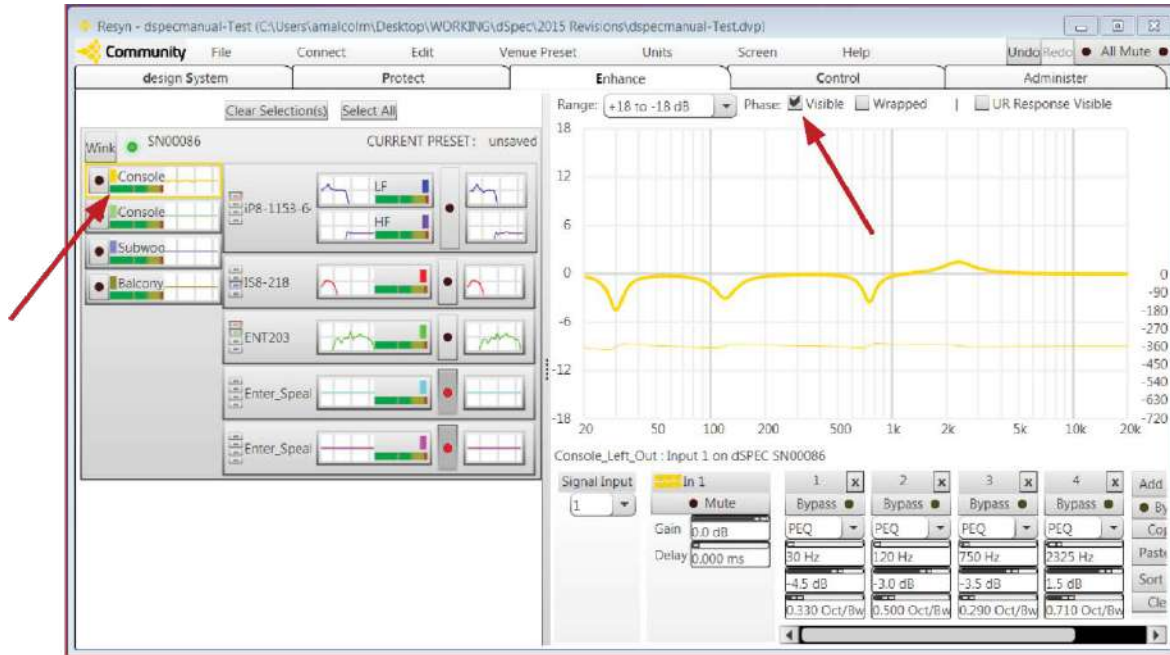

Notice that the active *Input* block on the left side of the screen is framed with a bright yellow border to indicate which *Input* trace (or traces) are being displayed on the right side of the screen (see **red** arrow). Also note that the "Phase/Visible" box has been checked, thereby displaying both a Phase vs. Frequency trace and an Amplitude vs. Frequency trace (see **red** arrows).

OF INTEREST: Also notice that the Input labels that were established in the design System screen (CONSOLE LEFT OUT, CONSOLE RIGHT OUT SUBWOOFERS (aux 1) and BALCONY DELAY) have been truncated due to space limitations on the Enhance screen, but by *rolling over* an Input section with your mouse, the full label and the name of the Venue Project are conveniently displayed, just as in the example shown next (see red arrow):



On the right side of the screen, take note of the Input controls. They include the following:

- **Signal Input.** This selects which *Signal Input* is routed to the *Input Processor*. If you select *Signal Generator*, an additional set of controls will appear on the left side enabling you to turn ON and OFF the *Signal Generator* and you can then select from *Sine*, *White* or *Pink* noise as sources. If you select *Sine*, you can control the *Sinusoidal frequency*. *All of the Signal Input selections* always allow you to control the *level* by using the small horizontal level control, and/or overprinting the numerical value in the *level readout* box.

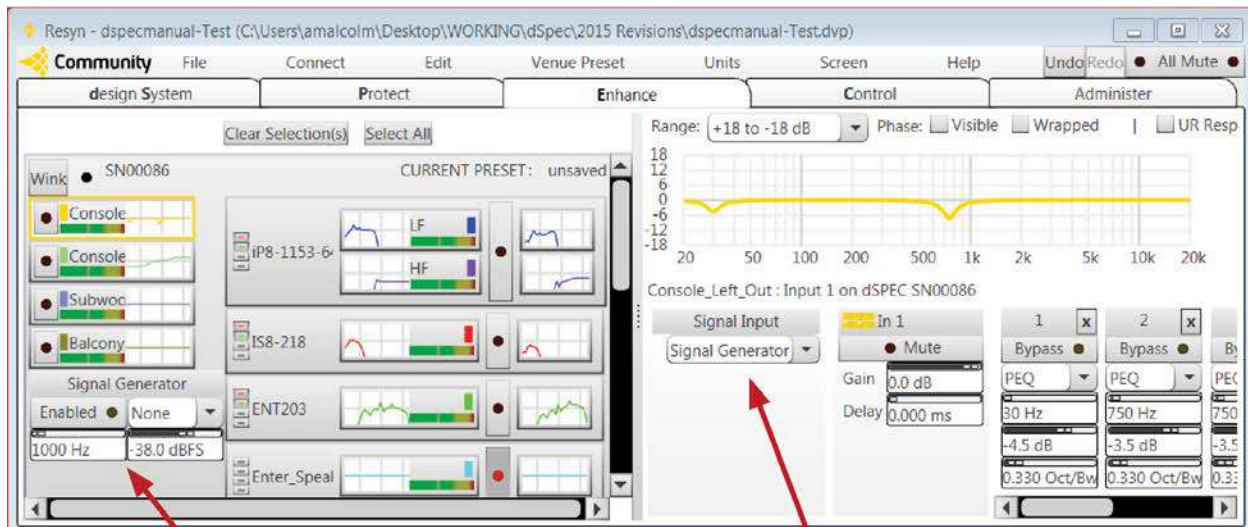

Level Control Bar and Level Readout

Signal Generator selected

- To the right of the **Signal Input** section you'll see the **Input Gain, Mute and Delay** controls. The range of **Gain** is -96dB to +15dB, and the range of **Delay** is 0 mS to 75 mS. Adjustments are made by positioning your cursor over the adjustment bar and then moving the mouse up and down – or left and right – while holding down the left mouse button. You can also position the cursor over the numerical display box and overwrite the current value with a new value from your keyboard. *Values that are too high or too low will be accepted, but they will be converted to values that are valid.*

Moving again to the right, you'll see the first of the Input Processor filters. In the example shown below, the Signal Generator and three PEQ filters have been activated:



Each *Input Processor* provides a total of six filters, and each of the filters can be selected as any one of the following:

- **PEQ** (Parametric Equalizer) with full control over Band Center (20 – 20 kHz), Bandwidth (.020 to 2.54 Oct/bw), and Gain (-40dB to +15dB).
- **Low Shelf** Frequency (20 – 20 kHz), Bandwidth (.3Q to 1.0Q), and Gain (-40dB to +15dB).
- **High Shelf** Frequency (20 – 20 kHz), Bandwidth (.3Q to 1.0Q), and Gain (-40dB to +15dB).
- **All Pass** Frequency (20 – 20 kHz), Bandwidth (0.1Q to 3.0Q).
- **Phase** Frequency (20 – 20 kHz), Phase Rotation (-180° to +180°)
- **Var Q LP** Frequency (20 – 20 kHz), Slope (12dB/Oct) Bandwidth (0.1Q to 3.0Q)
- **Var Q HP** Frequency (20 – 20 kHz), Slope (12dB/Oct) Bandwidth (0.1Q to 3.0Q)

Note: Var Q filters should be used carefully. They can be adjusted to extremes in which they are *under-damped*. This feature is very useful for establishing a Thiele-Small B6 low frequency alignment, and for other special circumstances such as CD horn corrections. They can also be used as traditional Low-Pass and High-Pass filters, but care must be taken to ensure that they are producing the response you are seeking; otherwise you can end up with as much as a 9dB significant boost in amplitude that occurs just before the roll-off portion of the curve, as in the example shown below:

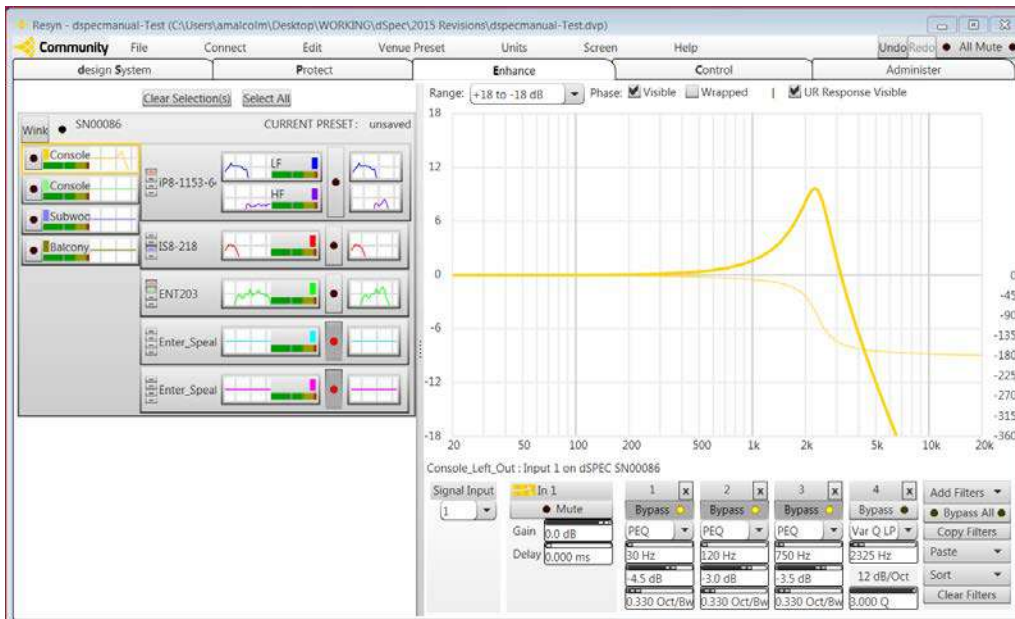

Note that as the “Q” of the filter is increased, so is its amplitude. In the above screen capture, the phase response is displayed with the lighter line weight and the phase values of the Cartesian plot are indicated on the right side of the screen (0 degrees to -360 degrees in 45 degree increments). The left side of the screen indicates the amplitude values (-18dB to +18dB in 6dB gradients).



In the screen-capture shown below, notice that two filters have been activated and one is still in the selection process:



IMPORTANT! You can add a total of six filters to any (or all) of the four *Input Processors*. Although filters can always be *adjusted* during a sound check or live event, *they cannot be added or deleted without interrupting audio for several seconds*. Therefore, we recommend that you add as many

filters as you think you might need in advance. They can always be deleted later - if not needed - thereby keeping unnecessary clutter off the screen. However, deleting one of more filters will take the dSPEC offline for a few seconds, so you don't want to do this during a live performance.

The last section on the lower right side of the screen is where you select *Add Filters*, *Bypass All*, *Copy Curve*, *Paste Curve*, and *Clear Curve*. When you select *Copy Curve*, dSPEC will attempt to copy the entire set of filters to the same *Input Processor* you're already working in, or to any of the other *Input Processor* that you select by clicking on it. If there are not enough filters available in the target *Input Processor*, the *Paste Curve* button will simply be grayed out.

Note: Filters can be copied and pasted between *Input Processors* and *Output Processors* as long as there are enough filter slots available to accommodate the number of filters copied.

IMPORTANT! Selecting *Add Filters*, *Copy Curve*, *Paste Curve*, or *Clear Curve* will cause dSPEC to go off-line for a few seconds, interrupting audio! So be careful!



Multiple elements can be selected. For example, two *Input Processors* are selected below:



This is accomplished by holding down the Control key while clicking on one or more additional *Input Processors*. The screen can get crowded when numerous filters and "Phase: Visible" are selected at the same time. However, this feature can be very useful as a means of comparing EQ among the various zones in your system. After multiple selections are made the primary selection (the yellow one that is being adjusted) can be changed simply by re-clicking on the already selected item. To clear selections use the "Clear Selections" button.

OF INTEREST: When it comes to displaying response plots, Resyn takes a giant step beyond the competition. By holding down the Control Key (Ctrl), you can click on multiple items on the **left** side of the Enhance screen which will generate a composite response plot on the **right** side of the screen in which all selected items are overlaid on a single response plot. We call this feature *Multi-Select* and

it's unique to Resyn. *Multi-Select* gives you a powerful means to view and compare response plots of more than one element in the signal chain including *Inputs*, *Drivers*, and *Outputs* - all at the same time, even across different dSPECs. **Note: you *cannot* Multi-Select more than one *Speaker* at a time** however you can multi-select more than one driver at a time – even from different speakers on different dSPECs.

IMPORTANT! Although you *can view* multiple response plots at the same time, you can only *adjust* the settings for one *active item* at a time. When you select an *active item* it will be identified by a yellow border surrounding it, and by the response plot of that item *turning yellow* in the large response plot on the right of the screen. After you have *Multi-Selected* two or more items, you can then navigate among them by simply clicking on them without holding down the Control Key. This will change the *active item* that you wish to control, while still allowing you to view the response plots of the *inactive* items.

The **Clear Selection** button to the right of the **Select All** button on the Enhance screen will clear any previous selections that you've made. Enhance is perhaps the most complex of the 5 Main Screens, so we recommend that you spend some time becoming familiar with the richness of its capabilities by trying various mock scenarios.



Now let's look at a screen-capture of a *Speaker* section in the Enhance Screen. In the example below, the Speaker select section has been clicked on (this is accomplished by clicking anywhere on the Speaker name driver - "IP8-1153-64" in this case), and evidenced by the bright yellow border surrounding it (see the red arrow on the left). In this example, the Speaker selected is a Community IP8-1153-64. Here you see the response traces of the LF Output and the MF/HF Output superimposed on the response graph on the right side of the screen. We've also ticked "Phase Visible," so the phase response is shown in the same colors as the amplitude response:

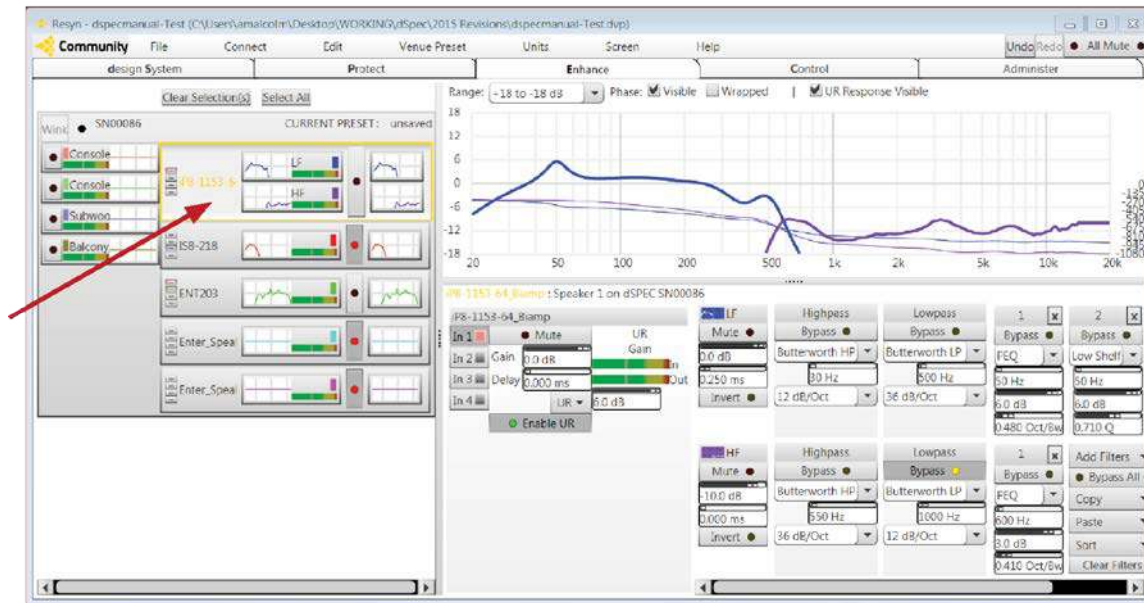

Additionally, because the "UR Response Visible" box has been ticked, the UR corrective filters are shown as well. In Expert Mode you can toggle the UR display ON and OFF at will, simply by ticking and un-ticking the UR Response Visible tick box. Uniform Response provides extensive corrective filters – 1024 of them to be exact – to flatten the Acoustic Power Frequency Response of the Speaker with which it is associated.

Here's how the same screen would look if "UR Response Visible" were to be turned off:

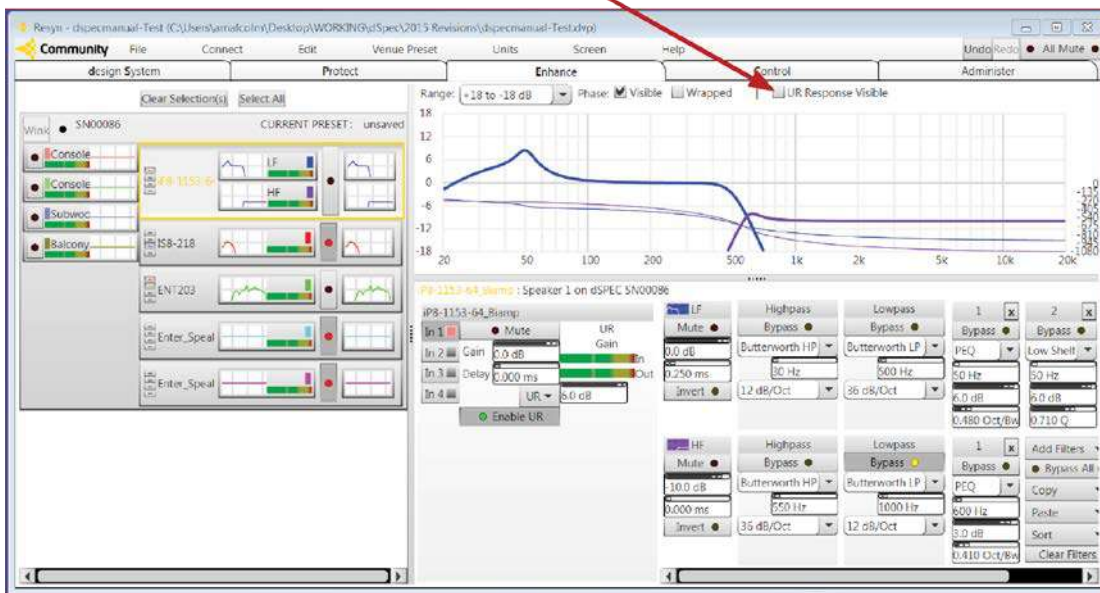

You can also click on just one of the driver boxes of a biamped, tri-amped (or other) Speaker to view only its response as in this example:

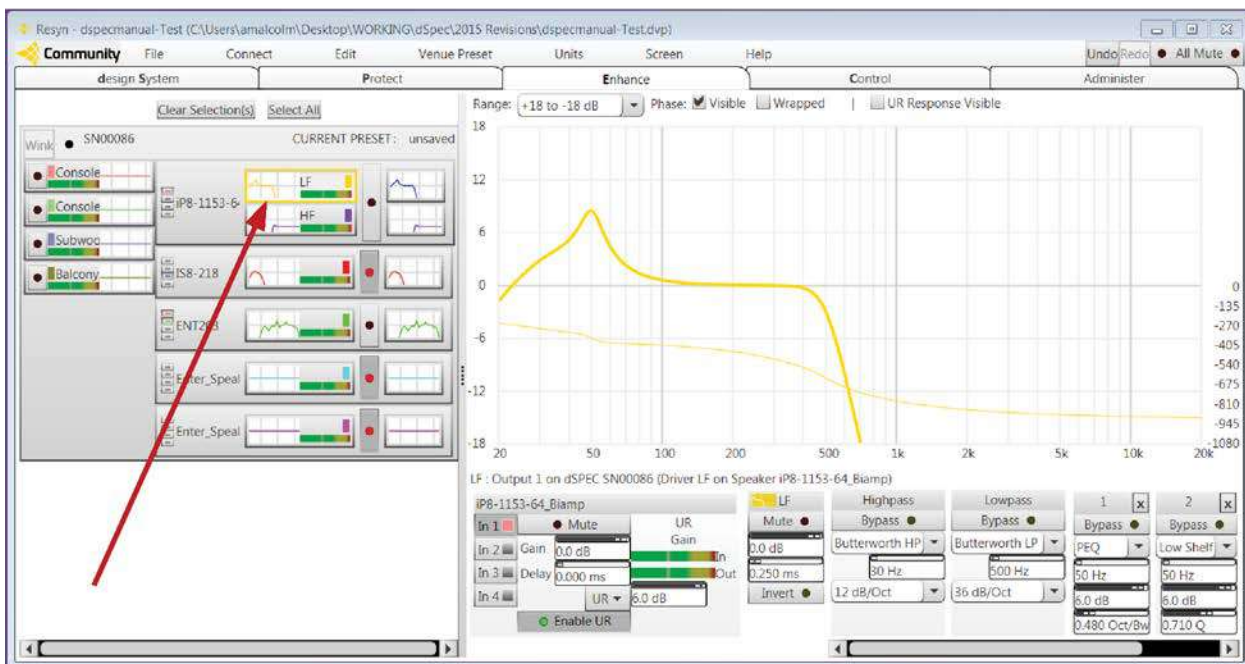

You can then add additional drivers (or Speakers) by holding down Control and clicking on one or more other boxes in order to compare them to one another, as depicted below:



This feature is very useful when you want to make sure that you've matched – or otherwise integrated – the various filter settings that you've established.

IMPORTANT! The element that's outlined in YELLOW is always the primary selection; the other(s) are viewable but not adjustable until re-selected to be the active element.

This next screen shows two drivers and two other Speakers all selected at once. Over-detailed? Sometimes yes. Useful? Absolutely! Especially when you need to compare one zone to another. Notice that the colors that outline each of the boxes correspond to the trace colors. Again, the yellow framed box is always the active one.

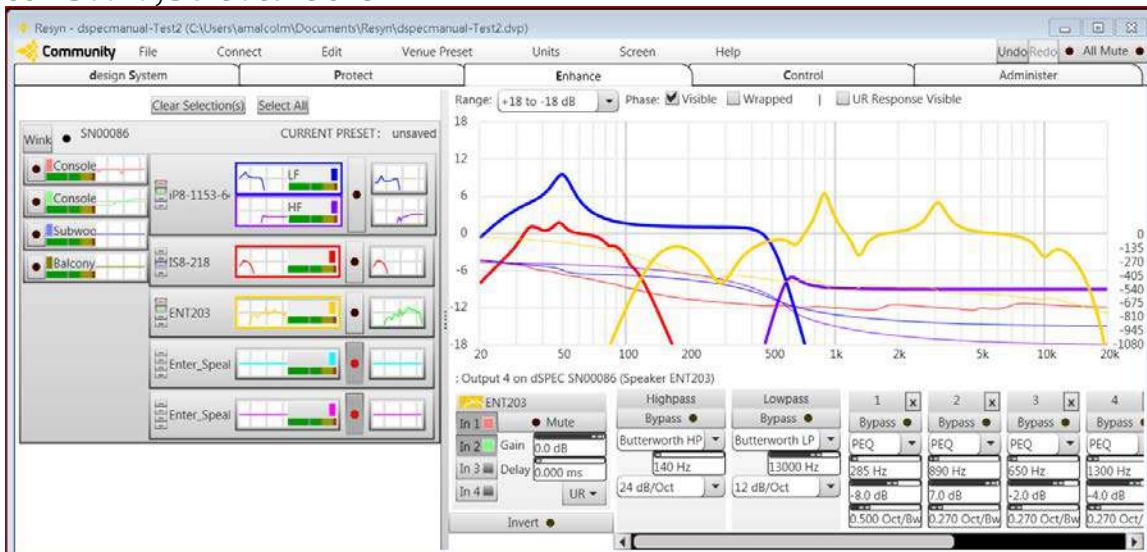

Moving on, the first section in the lower right side of the screen provides the four *Input Processor* select buttons that are identical in function to those on the design System screen. Here you can sum one or more *Input Processors* to one or more *Speaker DSP* processing blocks. In the example below, *Input Processors* #1 and #2 are both feeding the SLS960 Speaker (see the red arrow). In this section you can also control the Gain of the Speaker (-96dB to +15dB), and the Speaker Output Delay (0.0 to 395.99 mS). Note that because you're now controlling a *Speaker* (instead of an individual *Output*), any change that you make to Gain or Delay will be reflected in both the LF and HF Outputs - *if* the Speaker is bi-amplified.

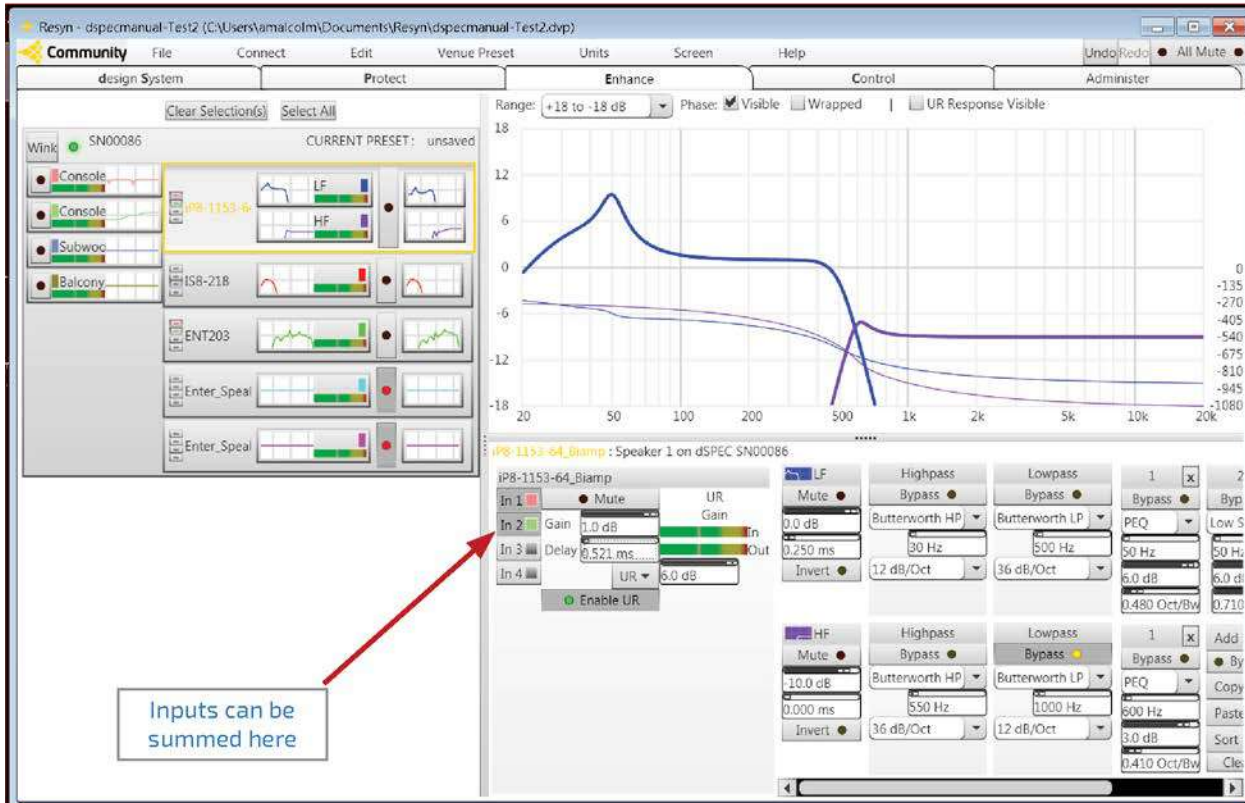

The same action would be true of LF, MF and HF *Outputs* if the Speaker is tri-amplified, (and so on) up to the full complement of 6 *Outputs*. This is one of the important features of dSPEC and Resyn that makes it so quick and easy to set up a system. You do not have to manually *link* the *Outputs* together for a multi-amplified loudspeaker when you want to change overall Gain or Delay, because it's already done for you.

One of the most important features in dSPEC and Resyn is that it "thinks" in terms of Speakers, rather than in terms of output channels. We "think" you'll like this!



The next section to the right provides control over the Gain of each individual *Output* of a multi-amplified Speaker; individual *Output Mutes*; *Incremental Delay* for driver alignment (0 – 3.999 ms in 21 μ s steps); and an **Invert** button that reverses the polarity of the Output. If you try incrementing the are the smallest intervals that are possible to select. This is governed by the sample rate of the master clock.

OF INTEREST: When you alter either the *Input Delay* or *Speaker Delay* you do not need to worry about maintaining the timing relationship of the incremental driver delay that aligns one driver to another in a multi-amplified Speaker. This holds true whether you have set the incremental delay value yourself, or if it's already been set for you by selecting a Community Speaker from the library. Whatever delay times you choose to add to the *Input* or to the *Speaker* will be added to the incremental delay time, as opposed to overriding it. This is one of the valuable reasons that we say, "dSPEC thinks in terms of Speakers," rather than in terms of Outputs.



Moving to the right again, you'll see two sets of Highpass and Lowpass filters, one above the other - because the example we're using depicts a bi-amplified SLS960 Speaker (note: a single-amplified Speaker would only show one set of Highpass and Lowpass filters).

These filters comprise the crossover for a multi-amplified Speaker, or the band-limiting at either the upper or lower end of the spectrum (or both) for a single-amplified Speaker).

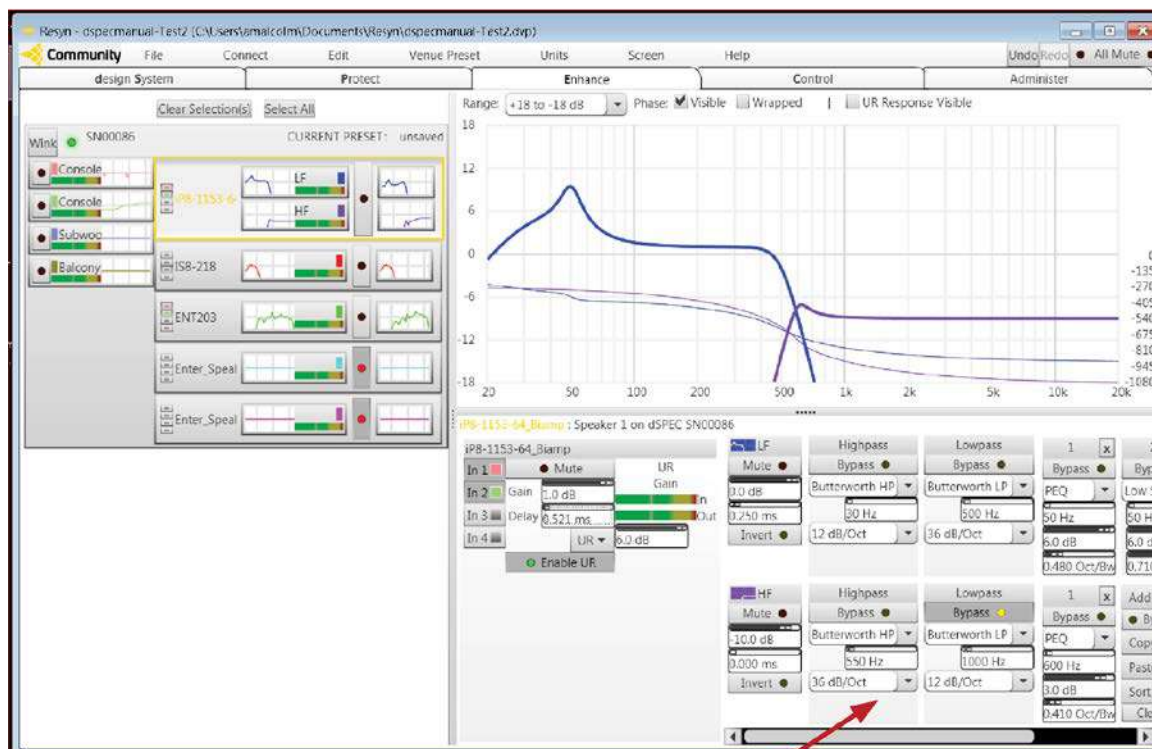

High Pass and Low Pass Filters

If you've selected a Community Speaker from the supplied library, here you can override *any and all* of the factory settings if you wish, but you'll need to save your changes under a **Custom Speaker** file name; **you cannot overwrite the factory Speaker files themselves!**

Conversely, if you're setting up a **Custom Speaker** for the first time, this is where you'll select your crossover types, slope rates, and frequencies. You do not need to use symmetrical crossover *frequencies* if you prefer not to, nor do you need to use symmetrical crossover *types* or *slopes*. It's perfectly possible to combine a 6 dB/Oct Butterworth Lowpass with a 24db/Oct Bessel Highpass - if you want to. In some cases, as with a low frequency cone driver that exhibits a steep roll-off in the upper region of its usable response range, it can be advantageous to apply a lower order of Lowpass filter to the cone driver, than to its companion high frequency driver - as just one example. However, in most cases it's best to set crossovers slopes to as high an order as possible, because it's the overlap in the crossover zone that causes most response anomalies - especially those occur off-axis where most of the audience is usually located.



The next section comprises the selectable *Output filters*. These behave exactly the same as the *Input filters* (described above in the *Input* section) except that each *Output Processor* provides 20 filters instead of the 6 that are provided with each *Input Processor*. The selectable filter types are also the same and are again described below:

- **PEQ** (Parametric Equalizer) with full control over Band Center (20 – 20 kHz), Bandwidth (.020 to 2.54 Oct/bw), and Gain (-40dB to +15dB).
- **Low Shelf** Frequency (20 – 20 kHz), Bandwidth (.3Q to 1.0Q), and Gain (-40dB to +15dB).
- **High Shelf** Frequency (20 – 20 kHz), Bandwidth (.3Q to 1.0Q), and Gain (-40dB to +15dB).
- **All Pass** Frequency (20 – 20 kHz), Bandwidth (0.1Q to 3.0Q).
- **Phase** Frequency (20 – 20 kHz), Phase Rotation (-180° to +180°)
- **Var Q LP** Frequency (20 – 20 kHz), Slope (12dB/Oct) Bandwidth (0.1Q to 3.0Q)
- **Var Q HP** Frequency (20 – 20 kHz), Slope (12dB/Oct) Bandwidth (0.1Q to 3.0Q)

Note: As previously mentioned, Var Q filters are powerful tools, but they should be used carefully. They can be adjusted to extremes in which they are under-damped. This feature can be useful for establishing a Thiele-Small B6 low frequency alignment, and for other special circumstance such as correcting HF compression driver upper-end roll off. They can also be used as traditional Low-Pass and High-Pass filters, but care must be taken to ensure that they are producing the response you're seeking; otherwise you can end up with a 9dB boost in amplitude that occurs just before the roll-off portion of the curve, as in the example shown next.

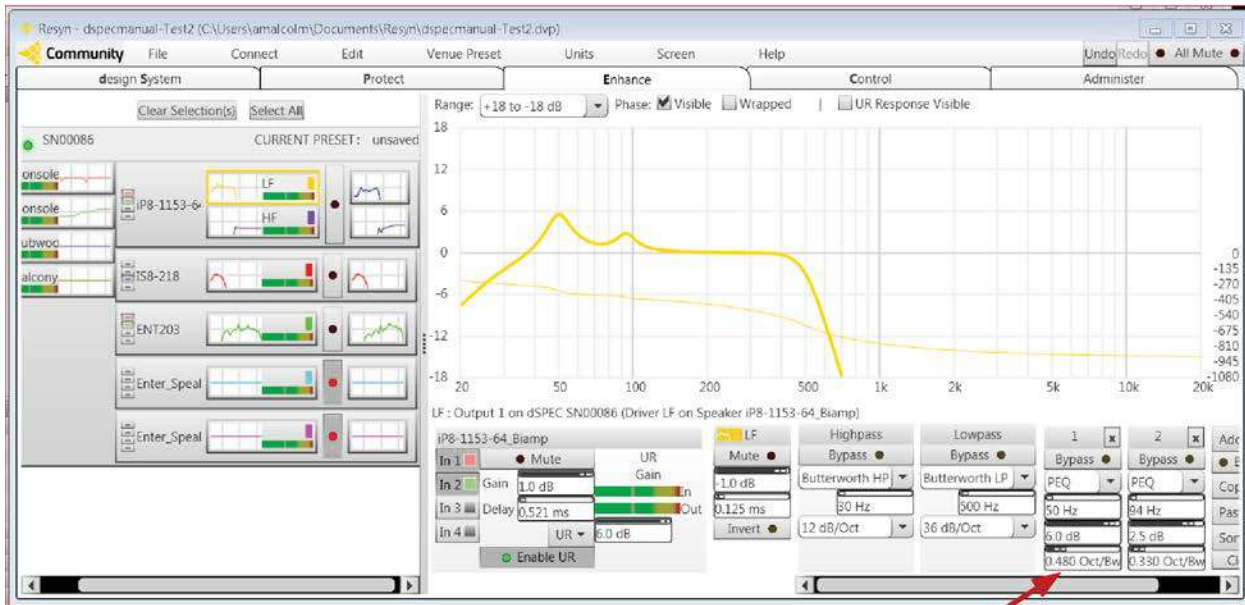

Output filters (typical example)
20 are available for each Output

IMPORTANT! You can add a total of 20 filters to any (or all) of the six *Output Processors*. Although filters can always be *adjusted* during a sound check or live event, *they cannot be added or removed without interrupting audio for several seconds*. Therefore, we recommend that you add as many filters as you think you might need in advance. They can always be deleted later, if they're not needed, to keep unnecessary clutter off the screen.

The last section on the lower right side of the screen is where you select *Add Filters*, *Bypass All*, *Copy Curve*, *Paste Curve*, and *Clear Curve*. When you select *Copy Curve*, dSPECMANUAL will attempt to copy the entire set of filters to the same *Output Processor* you're already working in, or to any of the other *Output Processors* that you select by clicking on them. If there are not enough filters available in the target *Output Processor*, the *Paste Curve* button will simply be grayed out. This same rule applies to Copying and Pasting Speaker filters as well.

IMPORTANT! Selecting *Add Filters*, *Copy Curve* or *Clear Curve* will cause dSPECMANUAL to go off-line for a few seconds, interrupting the audio signal! Be careful!



More on Adjusting Parameters

When you want to change a parameter in the *Detailed View* on the right – such as Input Level, Delay Time, etc., the process is exactly the same as we've previously described for changing parameters in the Input section and in the *Protection* screen. You simply position your cursor over any box that contains a numerical value. If you *click* the left mouse button, you can then enter a new value from your keyboard. Alternately, you can *hold down* the left mouse button and move the mouse left and right – or up and down. The direction of movement will *increment* or *decrement* the numerical

value in the box. Moving UP or RIGHT will *increment* the value; moving DOWN or LEFT will *decrement* the value.

OF INTEREST: The **Undo Redo** buttons work *across all screens*. For example, if you change the **Input Assignment** in **design System** then move over to the **Enhance** screen and click **Undo**, the **Input Assignment** will revert back to its previous setting. The **Undo Redo** buttons are not screen specific.

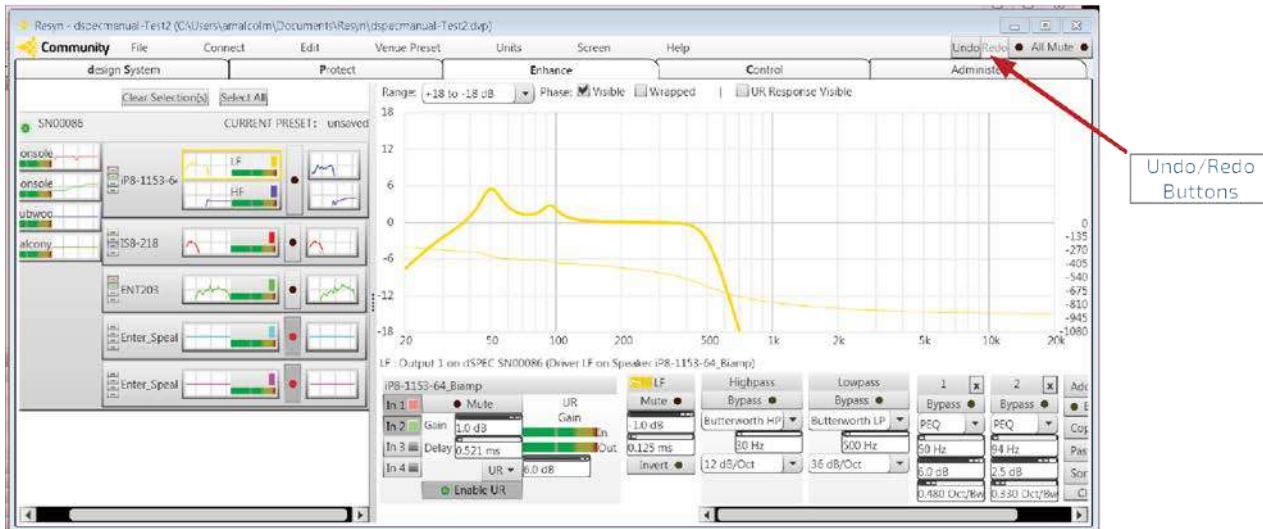

Overview of Enhance Screen Views

There are five (5) items that you can select in the *Navigation View* at the left side of the **Enhance** screen, simply by clicking on them. We have also provided **Undo Redo** buttons in the upper right corner of all five *Screen Tabs*. This lets you make trial changes to any of the operating parameters within *any Screen* that you're presently working in, without having to worry about how to restore your previous settings.

The five items in the *navigation view* (that's the left side of the **Enhance Screen**) are:

- dSPEC
- Input
- Speaker
- Driver
- Output

dSPEC Detailed View

Clicking on a dSPEC in the *navigation view* will bring up a “mixer-like” *overview* for an entire dSPEC. This *overview* will appear in the *detail view* (right side of the screen) whenever you click on the large box at the left of the screen that contains the Inputs, Speakers, and Outputs.

TIP: click on any area that's not occupied by graphics. The top of the box to the right of the **Wink** button is a good place to click, but it can be anywhere that's not populated with other elements. The following is an example of dSPEC's *Mixer* view:

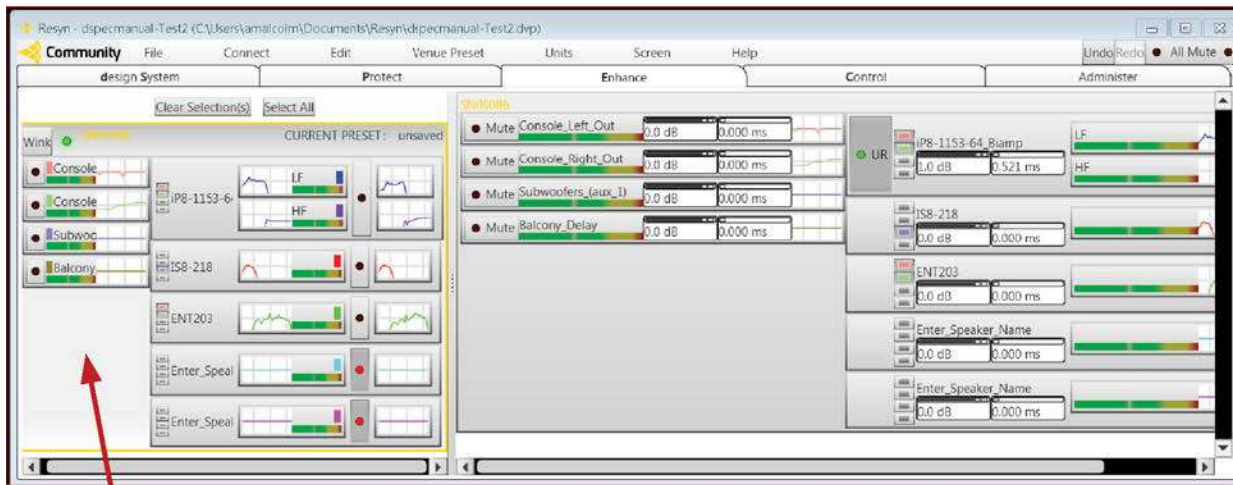

Click anywhere in this space to activate Mixer View

After you've clicked on dSPEC, it can take a few seconds for Resyn to re-calculate and re-draw the view on the right side of the screen. Note that the border of the dSPEC box that you just *clicked* will turn yellow to indicate that the process is complete and your selection is now the **active item**. This is **important** because **only an active item can be operated by the control boxes that appear on the right side of the screen.**



If you click on **Select All** in the upper left of the screen, *all* of the dSPECs in the **Venue Project** will be displayed in the *Mixer View* mode described above, along with appropriate scroll bars - if more than one dSPEC is present in the system as in the example on the next page.

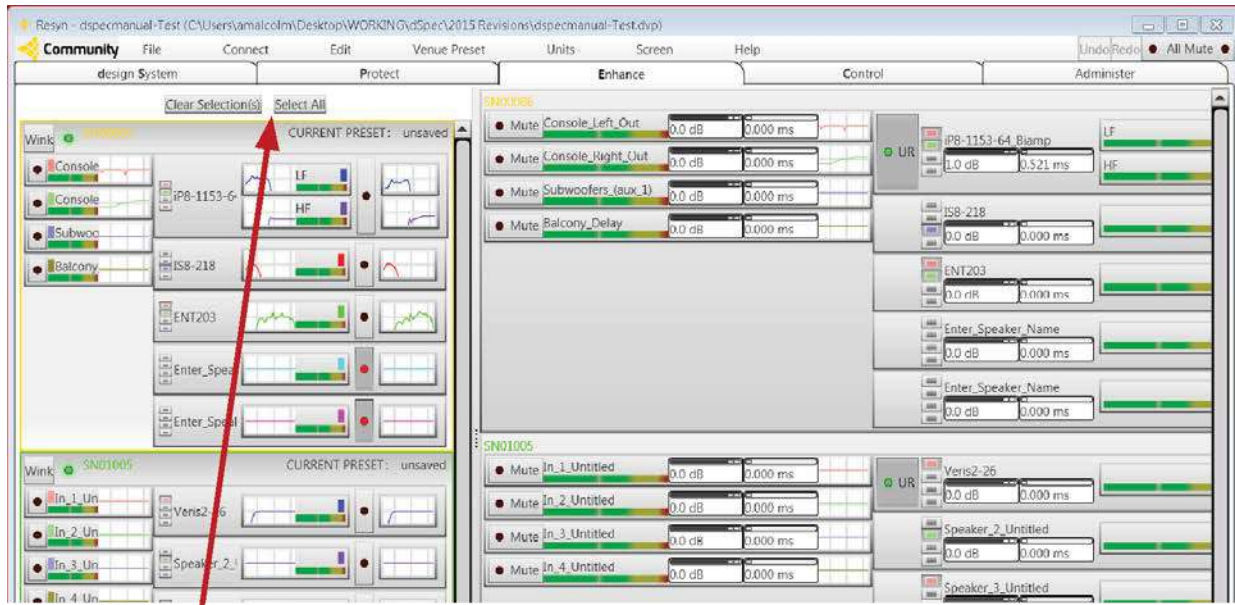

Select All button selects all dSPECS in a project

Notice that the all-important Gain Controls, Delay Controls, and Mute Buttons are accessible in this view for all Speakers – not Outputs (remember that dSPEC is oriented in terms of Speakers, rather than individual Outputs). We've also provided UR ON/OFF buttons in this view, as well as a UR Response Visible tick box.

Therefore, whenever a bi-amplified **Speaker** is present (this is an example only; it could also be tri-amped, quad-amped, or another configuration), only one **Mute Button** will appear for that one Speaker - and only one **UR ON/OFF** button. If you wish to **Mute** individual *Outputs* for troubleshooting, you can do so by clicking on each individual section of a multi-amplified Speaker, as depicted to the right in the screen-capture. Each *Output* (LF, MF, HF, etc.) will then be provided with individual **Mute** buttons.

The screenshot displays the Resyn software interface for speaker control. The main window shows a list of speakers and their outputs. The 'HF' output is selected, and its frequency response is shown in the graph. Below the graph, there are controls for 'Mute' and 'UR' (User Response) for the HF output, along with filter settings like Highpass and Lowpass. Red arrows point from text boxes below to the 'Mute' buttons for the overall speaker and the HF output.

Overall Speaker Mute Buttons

HF Mute Button



Input Detailed View

Clicking on an Input in the *navigation view* will bring up a detailed input view. This is where you assign *signal inputs* to *processing inputs* (you can also make these assignments on the *design System* screen and each screen will reflect the selections made on the other). Simply click on an *Input* box and all of its controls will appear on the right side of the screen along with a large response plot. Again, notice that the border of the box in the *navigation screen* will turn yellow to identify it as the *active item*. See the example below:

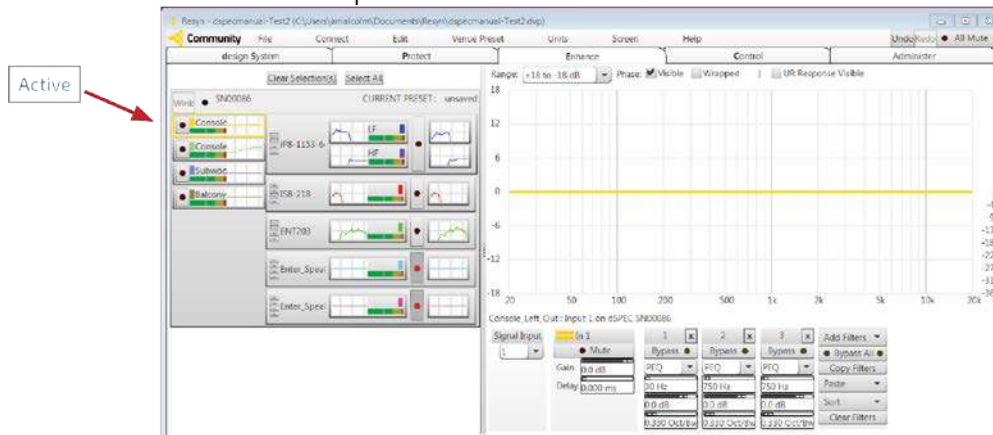

Whenever you make a change to Input Level or Input Equalization, your changes will be reflected in the small response plot in the *navigation view* (on the left side of the screen) *and* in the large response plot in the *detailed view* on the right side of the screen. Below is an example of Input 1 attenuated by 10 dB. The red arrows point to the change in both the *navigation view* (on the left side of the screen) and to the change in the large response plot in the *detailed view*:

Selecting **Input** also allows you to route any of the *Signal Inputs* to one or more of the four *Processing Inputs* by selecting the *Input* drop-down box on the right side of the screen, just as you can do in the *design System* screen (see the **red** arrow).

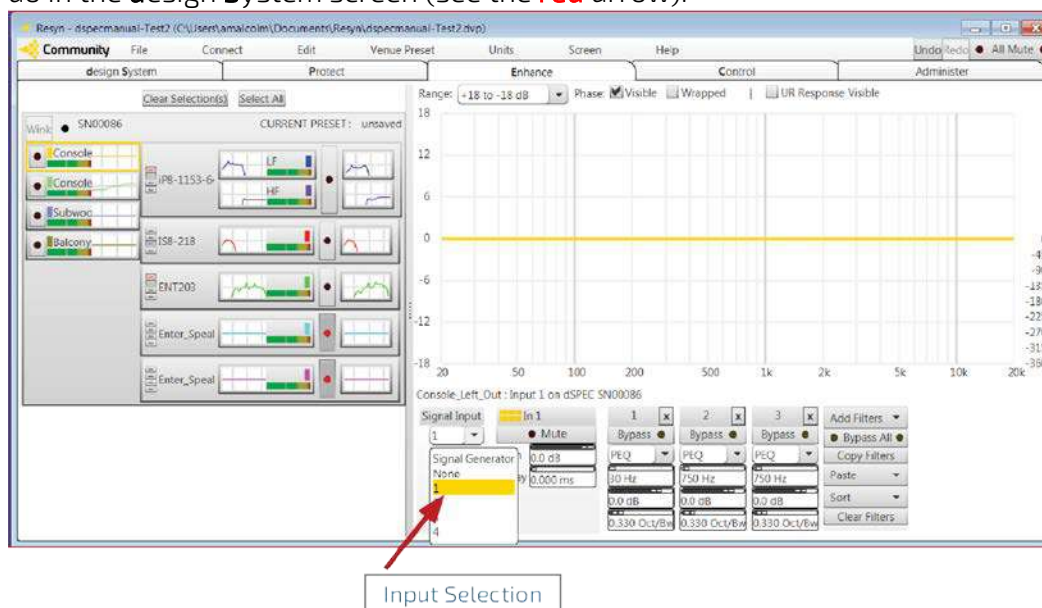

The choices are **Signal Generator** and **None**, followed by the number of *Signal Inputs* that are present on the particular dSPEC model that you are using. Although you can select among the available *Signal Inputs*, you cannot **sum** a *Signal input* with another *Signal Input* because that would be like paralleling two signals together with a Y-Cord. However, later in the signal path you **can** sum *Processing Inputs* to *Speakers*, thereby deriving a mono center channel Output, a mono subwoofer Output, a mono delay system feed, or other similar requirements.

If you select "Signal Generator" instead of a *Signal Input*, a small sub-menu will appear that lets you choose the type of signal generator you wish to use, and to also set the signal generator's level. The choices are Sine Wave (with selectable frequency), White Noise, Pink Noise, and None. Choosing "None" from the drop-down box (located directly below "INPUT") tells the Signal Generator sub-menu to go away.

The Input section is also where you'll set Input Delay Time (up to 75mS for each input), Input Gain, and choose the number and type of Filters that you wish to deploy for each Input (the maximum is 6 per Input). As mentioned earlier, filter types include:

- PEQ (Parametric EQ)
- Low Shelf
- High Shelf
- All Pass
- Phase
- Variable Q LP

IMPORTANT! You can always *adjust* filters in real time without audible artifacts, but when you *add* or *remove* a filter (either in the *Input* section or the *Speaker* section) dSPEC will go off-line while the procedure is executed and will not pass audio for several seconds.

Therefore, it's a good idea to add as many filters as you think you might need to use, in advance of an event or performance. The only downside is that you may have more elements on the screen than you actually need, making it slightly more difficult to move among them. This applies both to *Input* and *Output filters*. By adding only as many filters as you reasonably think you'll need, you'll only view the filters that you're actually using. This helps to de-clutter the screen, and makes the software run faster. Remember though, you can always delete unused filters at a later date, or add additional ones.

The *Input* section allows you to Mute one or more Inputs from either the left or right side of the screen. Simply click on any of the round black 'LED' dots that are in the Input boxes (in the *navigation view*), or on "Mute" in the *detailed view*. Selecting any dot will cause it to turn **red**, indicating that the Input is now Muted. The example below shows Inputs 1, 2, and 3 Muted, while Input 4 is un-muted because it carries a feed labeled BALCONY:

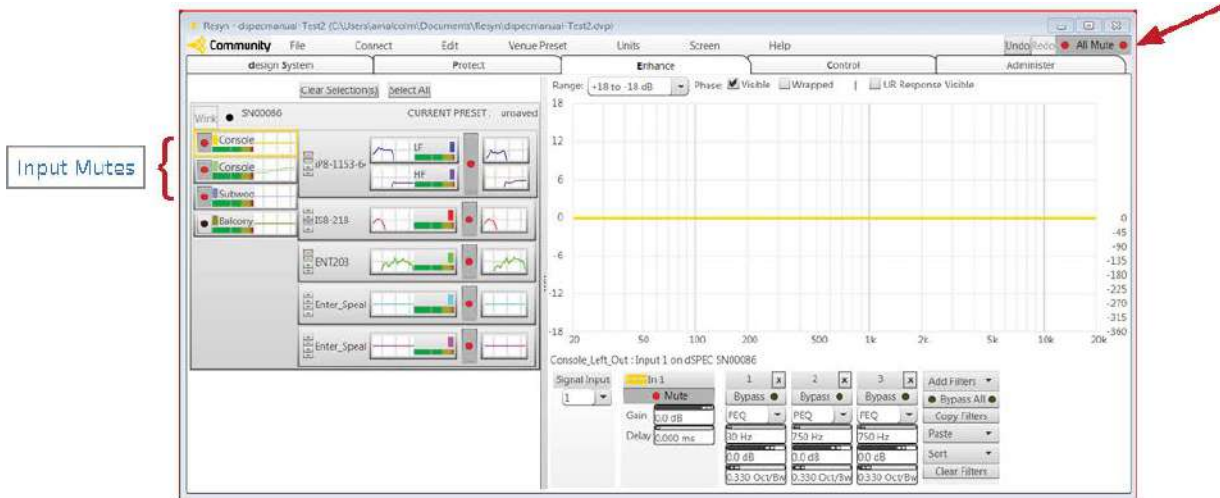

All Mute. Each of the five main screens provides an **All Mute** button in the upper right-hand corner (see red arrow). In the event of feedback, or other problems, the **All Mute** command can always be rapidly accessed to alleviate any problems that might occur, thereby avoiding damage to loudspeakers.



Speaker Detailed View

The Speaker Detailed View is shown by clicking on a speaker in the navigation view. A Speaker refers to the Speaker Model - or Speaker Type- that you've previously selected from the design System screen. The label will display the same text that you've already entered in design System (note: you cannot change labeling from the Enhance screen; if you wish to change or add a label, you must do so in design System). If no specific model has been selected, the labels will simply read "Speaker 1 Untitled," "Speaker 2 Untitled," and so on.

If a selected Speaker is single-amped, then a single box will represent that Speaker. If the selected Speaker is biamped, tri-amped, quad-amped or other, each of the individual channels that relate to that Speaker will automatically be grouped within the same box - and each output channel will be represented by its own response plot.

Whenever an *Input* is selected its button will turn a different color from the other buttons. The color change is reflected on the right hand side of the screen to help you keep track of your assignments. These are the same routing controls found on the design System Screen; either of these two screens will reflect any changes that have been made to the other screen.

Below is an example of a screen in which the LF Section of a Community IP8-1153 is the active element, but the Mid-High of the IP8-1153 is also being displayed.

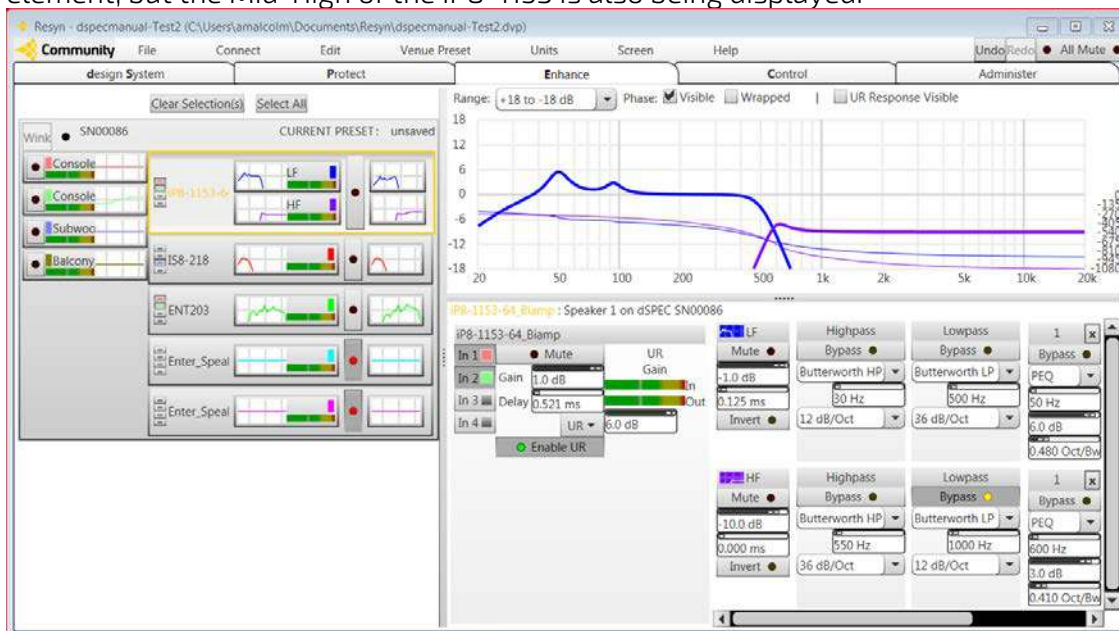

Driver Detailed View

Whenever a Speaker has been selected that's multi-amped (i.e. biamplified, tri-amplified, etc.), the individual sections within that Speaker will logically become **Drivers**.

Drivers represent the individual channels of a multi-amplified loudspeaker, which together comprise a specific model of Speaker. They default to the labels LF and HF for a biamplified loudspeaker; LF, MF and HF for a tri-amplified loudspeaker (and so on), but these labels can be changed at any time on the design System screen to any name you like. Conversely, single-amplified loudspeakers are more modest: they only get one name like R5-Coax99.



Output Detailed View

To the right of each Speaker (or Driver in a multi-amplified system) is an overall response plot that displays the composite or aggregate response of all filters in the signal path. However, it only displays the effect of Input filters if that specific Input has been assigned to the Speaker section of the signal chain.

As with *Inputs*, you can Mute any or all *Outputs* by clicking on each black 'LED' indicator that's located next to the Output response plots. The LED will turn **red** to indicate that the Output has been Muted. And again, if you click on **All Mute** in the upper right of *any* screen, *all* Outputs on *all* dSPECs in the entire system will immediately be muted.

OF INTEREST: note that the **All Mute** command affects only *Outputs*, not *Inputs*.

All Mute can be extremely useful for quickly protecting your system from sudden feedback or other issues, while you sort out the cause. After you've selected **All Mute** you can later un-mute *individual Output channels* one at a time for troubleshooting or other purposes. If you then re-select **All Mute**, all *Outputs* will once again be muted. Toggling back to an un-muted state will leave in place any *individual Mute* commands that you may have executed for either one or more *Inputs* or one or more *Outputs*. **All Mute** is *always* available in the upper right hand corner of the **Task Bar** in *all* of the 5 Main screens.

IMPORTANT! If one or more individual Outputs have previously been Muted, the **All Mute** button will not un-mute those channels when it's toggled back to its Un-Muted state.

In other words when **All Mute** is selected, it will mute all Outputs as expected... but when you 'lift' the **All Mute** command, it will not 'undo' any individual Mute commands that were previously made to individual channels. Any channel that was previously muted will remain muted until you un-mute it on an individual basis.



- **Control Screen Tab**

The Control Screen Tab provides operation and configuration of External Control. As we've mentioned earlier, one or more dSPECs can be controlled by remote switch closures that call-up as many as six different **Presets**, or each dSPEC can have as many as six remote **Level Controls** that can adjust the level of an *Input*, an *Output*, or *both together*, within a pre-defined range of limits. User **Presets and Level Controls** can be mixed together up to a total of six for each dSPEC. Moreover, a remote switch closure can control many dSPECs, which opens up a vast range of possibilities for many isolated systems to share common control features. For example, a group of 10 outdoor stages, 20 restaurants, and 15 nightclubs in an amusement park, each with one or two resident dSPECs, could *all* respond to an Emergency Page override command activated by either a manual switch closure, or an automated switch closure from an alarm system, to warn of a fire or other imminent threat. Numerous other scenarios that merely change permissible volume levels from day time events to night time activities are of course possible as well.



Presets and Wall Control View

The screen shown below is the default screen named **Presets and Wall Controls**. It's the first screen to appear when you select the Control Tab. Below is a representation of a Control Screen that has two **Level Controls** and two **Presets** assigned.

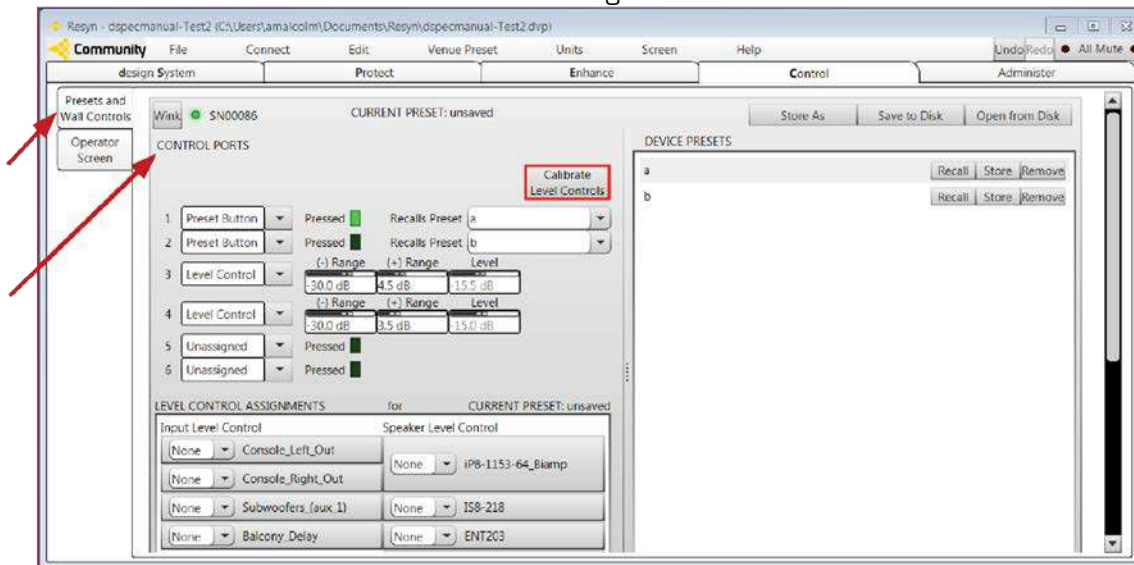

OF INTEREST: Each of the six Control Ports can be assigned to a *Remote Preset Selection Switch*, or a *Remote Level Control*, but not both at the same time.

To assign a **Preset** you need to first create it and name it using the **Store As** command, or **Recall** an existing **Preset** using the **Recall** command. These are found under the **Venue Preset** drop-down menu on the **Task Bar**.

Note the **CONTROL PORTS** section at the left side of the screen (see red arrow) and the numbers 1–6 below the heading. When you assign a **Preset** that will be used with a *Remote Preset Selection Switch*, the numbers (1–6) indicate the numbers of the 6 **Control Ports** on the rear panel to which you'll make your physical Remote Switch connections.

When a Remote Switch is pressed, a green LED will illuminate to the right of the Preset Button to indicate the **Preset** that is presently active.

OF INTEREST: You can use either *momentary* or *steady-state* switches to remotely activate a **Preset**. If momentary, the green LED will illuminate only briefly. If steady-state, it will remain illuminated until the switch closure has been interrupted.

OF INTEREST: In the event that more than one Remote Selection Switch has been designed into the system (which can be very useful), and two or more Remote Switches are in conflict with one-another, dSPEC will *always* respond to the lowest number of the 1-6 Control Ports, even if all 6 have been inadvertently activated simultaneously.

OF INTEREST: The current Preset will be labeled at the top of every *dSPEC in Resyn*, which includes of course the **Control Screen**. In the screen capture shown above the label is "CURRENT PRESET: EXAMPLE_1."

OF INTEREST: Remember that you can create, **Store** and **Recall** many more than 6 Presets yet after 6 you'll need to Recall the **Presets** via Resyn software with a computer connected to the system, rather than a Remote Selection Switch. In all but very complex applications, three or four **Presets** are usually enough to handle a wide range of changing conditions.



When a **Level Control** is connected and assigned to a Control Port, a group of controls will appear that are labeled **(-)Range**, **(+)Range** and **Level**. These controls let you set the minimum and maximum permissible levels. Note: maximum and minimum levels are *relative* to the levels previously set for each Output and each Input channel; they do not *override* previously established Input and Output level settings but rather, work within the established framework.

For example, a **Level Control** located behind the bar in a restaurant could be limited to a range of just ± 3 dB to avoid large volume changes by the bartender who might not be able to hear the system in the dining room. Later, by switching to a different **Preset**, the permissible range could be increased, the dining room speakers muted, and an entertainment system activated in the bar area. Now the bartender can adjust the levels appropriately, because she can now hear the local loudspeakers that were activated by the change of **Preset**.

When you assign a **Level Control**, a box labeled **Calibrate Level Controls** will be framed in red. When you click on this box, you'll see a new message appear on the screen as in the example shown below:

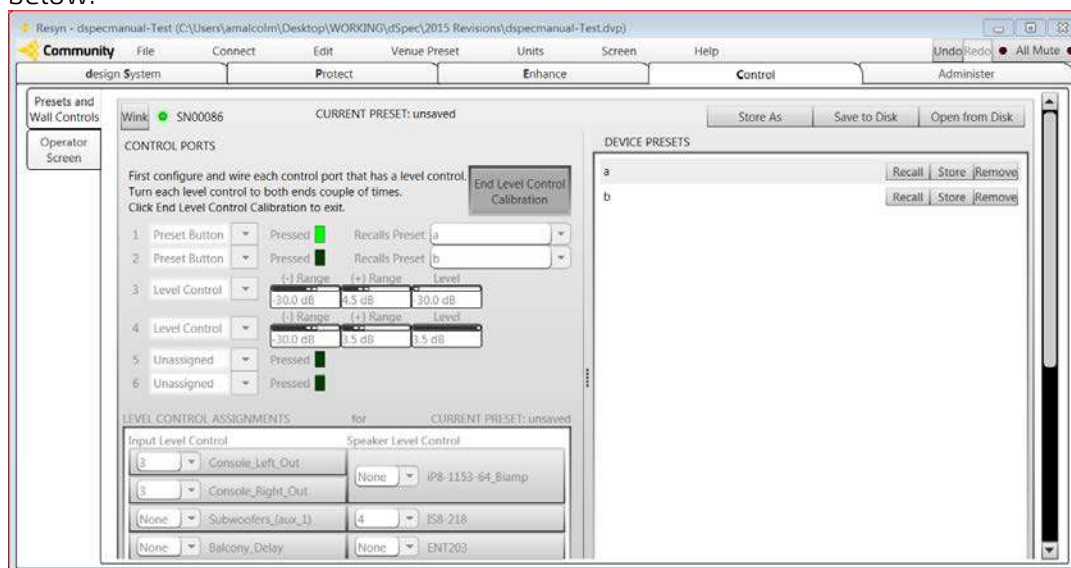

The new message will prompt you to first *connect* the **Level Controls** and then to *rotate* them from one extreme to the other two times. This short routine lets dSPEC learn the voltages that appear at either extreme of the potentiometer's rotation, thus calibrating the range of motion. Moreover, by using dSPEC's calibration routine, you'll be compensating for the resistance in the cable that connects dSPEC to each of the **Level Controls**. Lengthy cables can exhibit enough resistance to generate inconsistencies, were it not for dSPEC's calibration feature. The calibration feature allows you to use light gauge cable, such as Belden 8451 (or equivalent), even if the **Level Controls** are located hundreds of yards away from the dSPEC they are controlling.

OF INTEREST: The actual value of the potentiometers is not particularly critical, but a 20k ohm CW linear-taper is a good choice. Community sells the RLC1, which fits neatly into any standard single-gang NEC electrical box (2" depth), for this just purpose.



CAUTION! Do not use potentiometers that are lower in value than 1k ohm to prevent damage to your dSPEC!



In the bottom portion of the Control Screen you'll see two sections labeled **Level Control ASSIGNMENTS** for **CURRENT PRESET: EXAMPLE 1** (see the **red** arrow in the screen capture below):

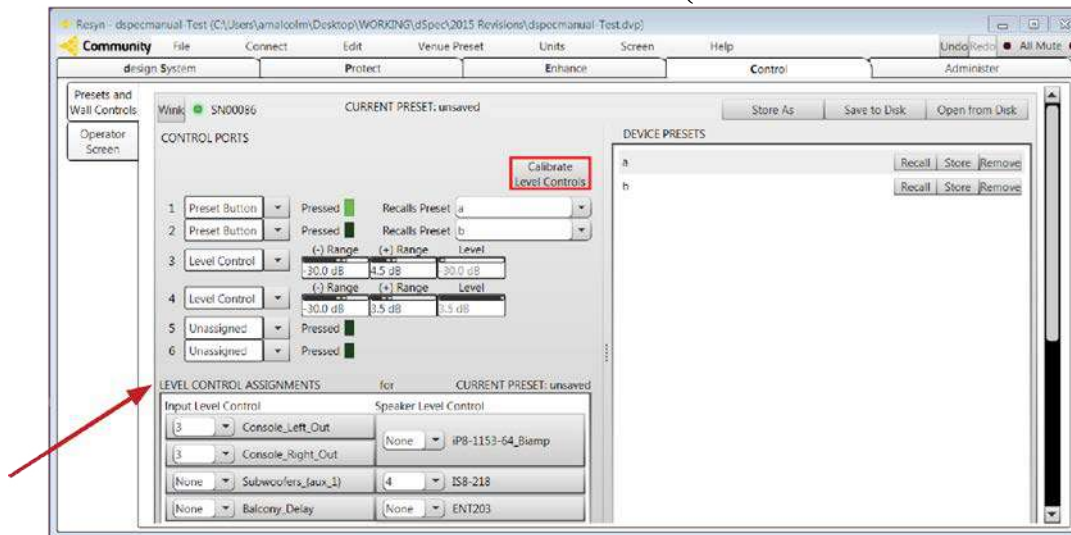

The numbers directly below the screen labels: "Input Level Control" and "Speaker Level Control," relate to the numbers of the **Control Ports** on dSPEC's rear panel. In the above example Control Port "3" is wired to a remote **Level Control** that will control the *Input Volume* level of the Inputs labeled Console Left / Right Out. Similarly, Control Port "4" will control the *Speaker Volume* level of the IS8-218.

Any **Level Control** can control the *Input* volume Level, the *Speaker* volume Level, or both simultaneously. Assignments can be changed at any time *either manually or via presets*.



Operator View

Next, on the Control Screen there's a sub-tab accessible on the left called **Operator Screen**. Clicking on **Operator Screen** changes to a look like this example (below):

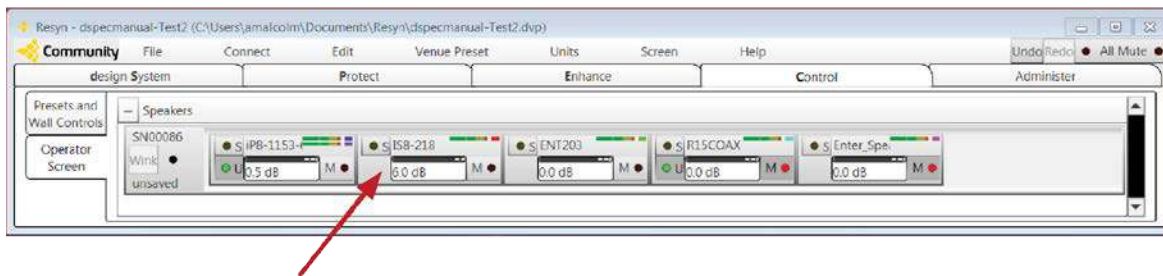

The **Operator Screen** is very cool! It provides functions that we refer to as being of *Primary Importance*. They each apply to the *Speakers* that you've established in dSPEC (remember that dSPEC thinks in terms of *Speakers*, not *Channels*). The functions are **Level and Mute**. This is the screen to use if you need to quickly balance different *Speaker Levels* and/or troubleshoot the system using the *Mute* commands. Although these functions can be executed elsewhere, the **Operator System** Screen puts them in one place for your convenience. Because this Screen uses a lot less space than the 'Mixer View' on the **Enhance** Screen, you can view and control many dSPEC's at the same time, without scrolling and possibly losing your place. **Operator System** is probably where you want to be when starting a live performance that utilizes numerous dSPEC's. Later, switching to the **Enhance** Screen will let you make EQ and other adjustments, once you have established the Prime Operating Parameters of the system.



Recapping User Presets and Wall Controls

Many installations need to be re-configured on-the-fly for different usages, sometimes numerous times each day. It's not always appropriate to use a computer to execute the changes.

dSPEC solves this problem by providing six External Control Ports. The Control Ports are simply a set of Euro-style terminal blocks with detachable connectors – the same connectors that dSPEC uses for audio Inputs and audio Outputs.

Each Control Port can be configured in two ways. First, a port can be set to respond to a simple remote switch closure, which in turn will call-up a **Preset** that can alter *any* or *all* of the parameters and settings that reside in each dSPEC's internal memory. Multiple dSPEC's can respond simultaneously to a single remote switch closure.

For example, one **Preset** might configure a hotel ballroom for daytime meetings in which the podium is located at the front of the room, while another **Preset** might change the configuration to banquet-style seating with the head table located off to one side, for evening events.

Or maybe you want to add a whole lot more protection to a restaurant system after the dinner guests have left for the evening (it's well known that restaurant sound systems are usually damaged *after hours* by staff who are finishing up work and decide to crank up the system). You can provide your client with an **"Added Protection Preset"** that's activated by simply touching a switch on the wall as the restaurant manager leaves her office.

Presets can be used to change loudspeaker delay times, gain, EQ, protection levels, which loudspeakers are active and which are not, how loud a system can get...in fact anything and everything that dSPEC does can be stored and later recalled as a **Preset**. You can even create a significant level of *signal routing* though the use of Presets. For example, one **Preset** might permit a dSPEC to be fed solely from the house mixing console; another **Preset** from a DJ booth; still another from a Security Page Override Announcement source. The possibilities are almost endless, especially when using multiple dSPECs.



Presets do not necessarily *have* to be activated by means of external switches. While they are always *created* within Resyn, they can be activated by Resyn as well. Up to 255 **Presets** can be created and recalled from Resyn, while six **Presets** can be assigned to the six External Control ports at any one time.

Level Controls. Each of the six dSPEC Control Ports can be used with a remote **Level Control** instead of a remote **Preset Button**. Just like **Preset Buttons**, remote **Level Controls** can be located wherever you like. When assigned as a **Level Control**, each Control Port can be set to control the level of one or more *Inputs*, one or more *Speakers*, or one or more *Inputs* and *Speakers* at the same time. Additionally, you can set the Minimum and Maximum range for each **Level Control**. Resyn provides a simple routine that calibrates the remote **Level Controls** to the software. Used together, remote **Level Controls** and remote **Preset Buttons** can provide a wealth of creative solutions to common installation challenges, that otherwise would cost far more and take much longer to implement.

In **Appendix "C"** we provide detailed information on how to connect a remote **Preset Button** and a remote **Level Control** to dSPEC's six Control Ports, as well as additional information on how to use the features in the **Control Screen**.



• Administer Screen Tab

The Administer Screen Network allows you to change Networking parameters, check for and install Firmware Updates, as well as establish Passwords and obtain Diagnostic statistical information.

The Administer Tab is divided into four views: **Networking**, **Firmware**, **Security** and **Diagnostics**. These selections appear at the left hand side of the screen. The initial screen will default to the **Networking** sub-tab.

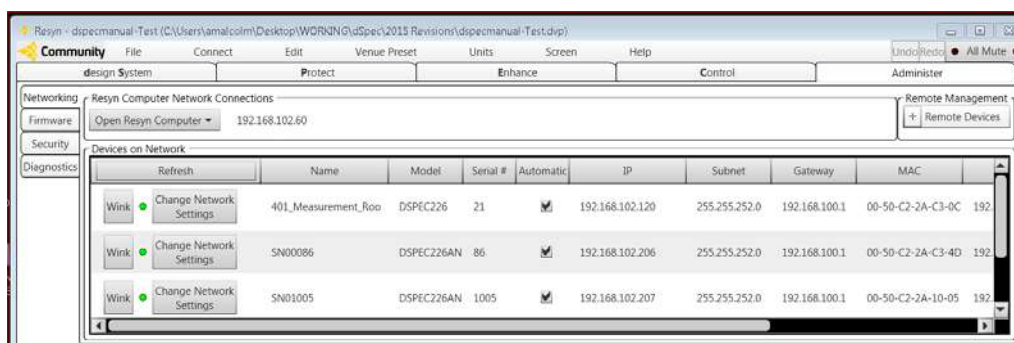

Networking View

The Networking sub-tab in the Administer Screen is shown on the previous page. This screen provides the name, model type, and serial number of each dSPEC in the **Venue Project** that's presently connected and on-line. Additionally, this screen contains the IP address, Subnet mask, Gateway, MAC and "via Local" information.

If you need to change the IP address, Subnet mask, or default Gateway, simply click on the **Change Network Settings** button and the following dialog box will appear:

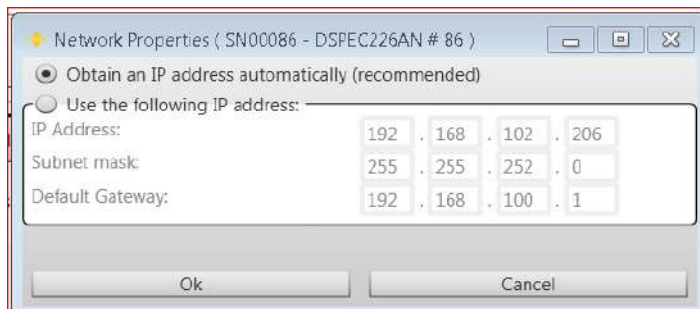

By clicking on the button to the left of **Use the following IP address**, you can manually enter new values in the 12 text boxes. If you do not click on **Use the following IP address**, the text boxes will be grayed out and you will not be able to alter the values.

! WARNING! Do not change these values unless you have a thorough understanding of network configuration. We recommend that you let Resyn auto-detect the dSPECs in your system unless you have a specific reason for setting a static IP address or modifying the other settings.

Firmware View

Next in the Administer Tab is **Firmware** as depicted below.

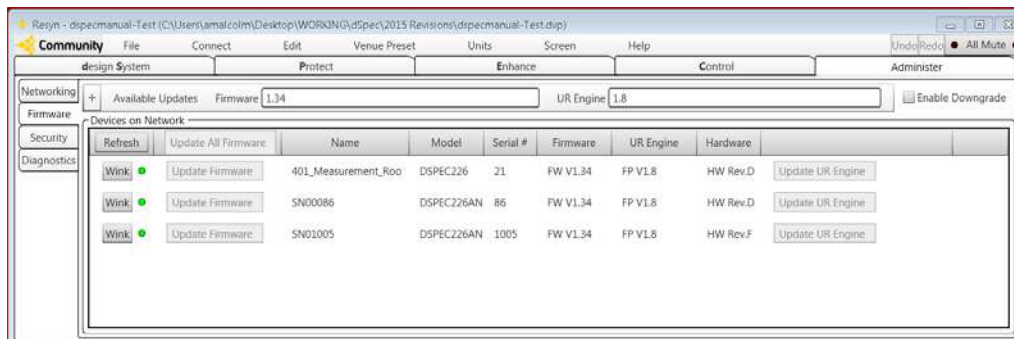

This screen lets you conveniently check the current version of Firmware and of the UR Engine in your dSPEC to see if they are up to date. If they are, the **Update Firmware** and **Update UR Engine** buttons will be grayed out. If the buttons are displayed as active, that means that there has been a later release which you can access just by clicking on the respective buttons.

CAUTION! Make sure to power-down any amplifiers connected to dSPEC before executing a Firmware update to avoid possible damage.

Security View

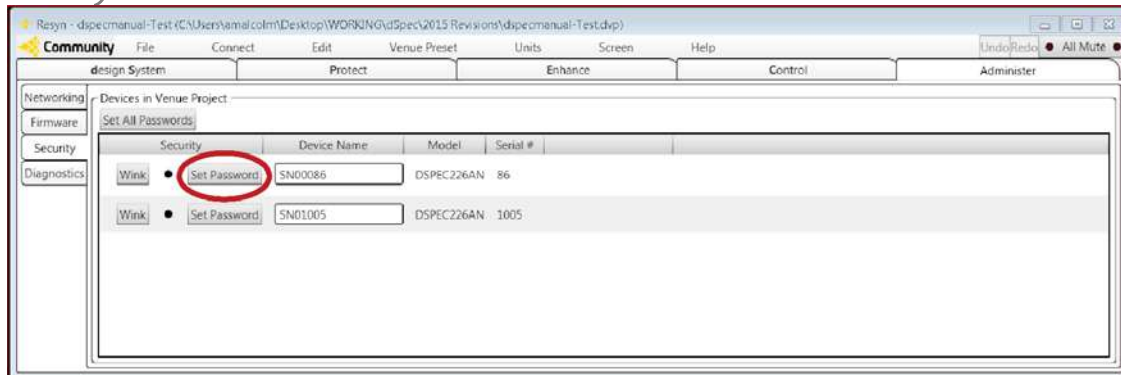

Notice that the **Set Password** button for the connected dSPEC is active. Passwords always reside in dSPEC *hardware*, not in Resyn software. By selecting the **Set All Password** button, you can assign a common Password to *all* of the dSPEC's in a **Venue** project in one simple operation. However, **Set Password** will be grayed-out, if any additional *actual* dSPECs are not connected and properly docked to Resyn.

When you set a Password, you'll be greeted with a dialog box that looks like this example that we've shown below:

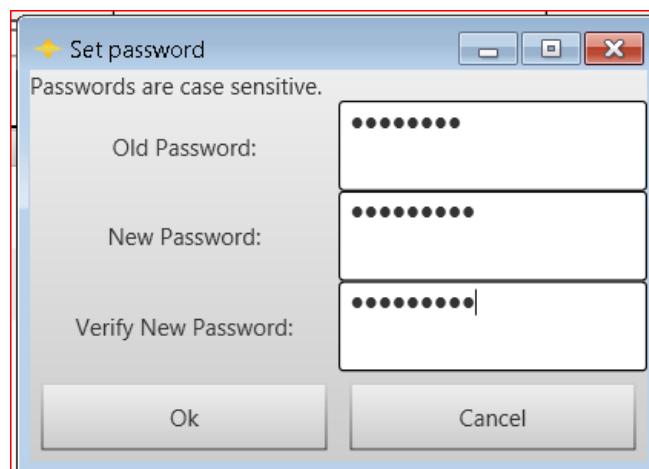

IMPORTANT! The default Password for all dSPECs is **dspec123** and is case sensitive. If you change it, you will want to make a permanent record of the change. *This is very important in order to be able to access password protected functions at a later time.*

Diagnostics View

The *Diagnostics* function presents no privacy issues of any kind, but allows collection of data that can be used by our engineers to make better products in the future. **The user should only enable this function at Community's request to aid in diagnosing trouble with a particular system.** The diagnostics tab is only available when Expert Mode has been checked from the design | System Options screen.

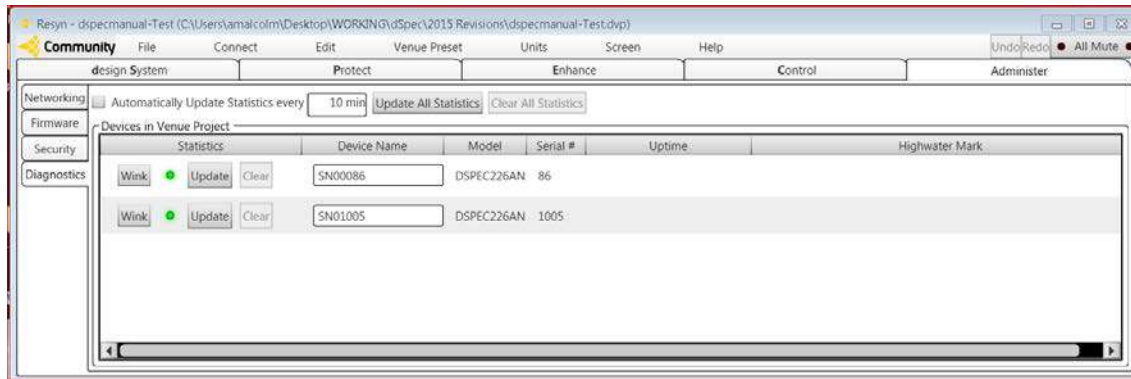

Resetting dSPEC

IMPORTANT! In the event that a problem arises that cannot otherwise be solved, dSPEC hardware can be completely reset. This will restore all original factory settings **except for any changes that you have made to the Password!**

To reset dSPEC, simply use a paperclip (or similar implement) to depress the recessed Reset Button on the rear panel. Depress the switch and hold for one (1) second. All of the Input Green LEDs on the front panel will blink and the green LED on the Ethernet jack will blink for five (5) seconds. Now, if you depress the recessed switch one more time within the 5 second window before the LED's stop flashing, your dSPEC will reset and restore all factory settings *with the exception of the Password*, which will remain in memory.

In the event that you've lost your Password and need to alter Password-protected settings, please contact Community for further instructions.



Help!

Lastly, let's look at the **Help** Menu. **Help** is accessed by selecting **Help** from the **Task Bar**, or by pressing **F1**. The choices that appear are **Reference Manual**, **Connect Troubleshooting Guide**, **dSPEC Hardware Manual**, **Manuals for the RLC1 and RPS4**, **Remote Management Manual**, **Quick Start Guide**, **Product Documentation**, and **About Resyn**. (Note: you can access the Reference Manual at any time by pressing **F1**).

Selecting **Reference Manual** will bring up a .pdf version of this Reference Manual. You will need to have a PDF Reader installed on your computer, which is a free application available for download from Adobe and others.

The printed **dSPEC Hardware Manual** and **Quick Start Guide** were included with your dSPEC and give you a quick overview and brief set up instructions.

The **Connect Troubleshooting Guide** will provide basic connection troubleshooting tips. The **Remote Management Manual** provides instructions on accessing your dSPEC units over your internal network or offsite via VPN.

Selecting **Product Documentation** will call up a list of the files that were included with the current version of Resyn. These include the all of the documents above as well as useful application notes, Service Bulletins, detailed instructions for installing the RPS4 Remote Preset Recall Switch and the RLC1 Remote Level Control, and current version release notes.

The last choice, **About Resyn**, provides information on the current version of Resyn that's installed, as well as displaying file and path information.

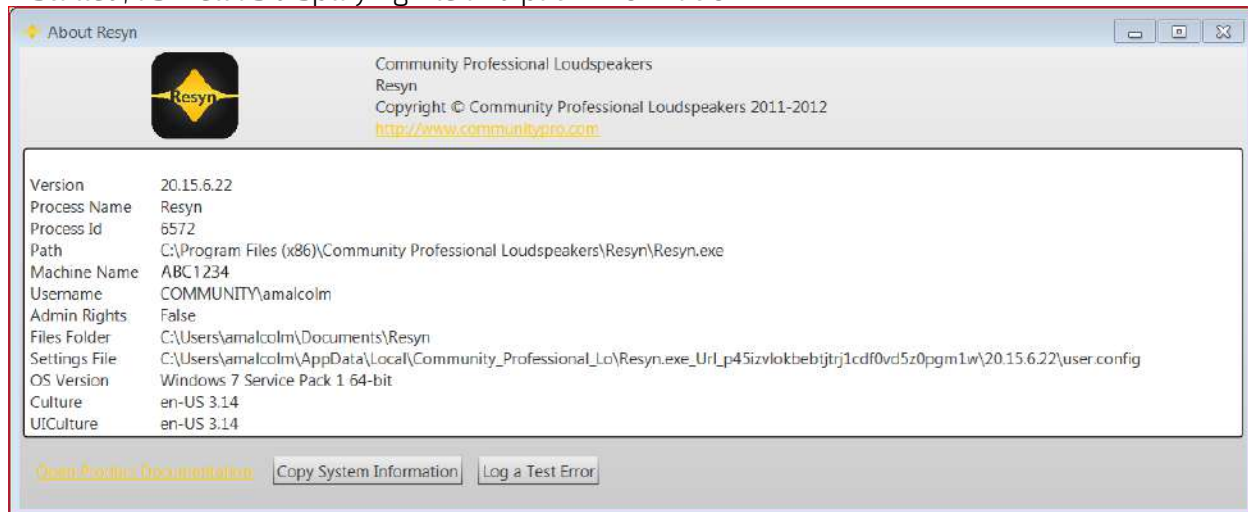

From this screen you can access the **Open Product Documentation** command directly, without needing to go back to the **Help** menu on the **Task Bar**. You can also click on **Copy System Information**. Copy System Information will copy the ".log files" and the "user.config" files to the Windows clipboard, thus enabling you to paste them into an email to send to the factory for assistance, should you require it (use **Ctrl+V** to execute the *paste* command). Whatever is in the **Venue Project** at that time will be copied to the default Venue .dvp file when you select Copy System Information. An example of a service request email is shown on the next page:

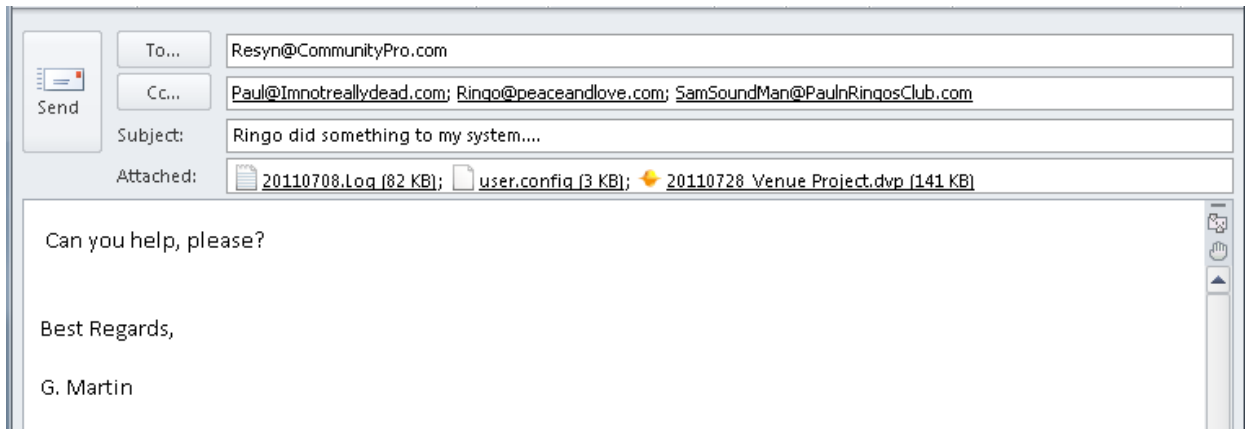

As we mentioned at the beginning of this Reference Manual, the world of digital audio is changing rapidly. Community is committed to keeping up with these changes, so please check our website regularly for the latest information including application 'White Papers', updated versions of software and firmware, and other useful facts that can help you to get the most from dSPEC and Resyn. Find us at: www.communitypro.com

###

APPENDIX A

DSPEC FILE STRUCTURE

Understanding File Types

There are six PC file types for **Saving** and **Opening** dSPEC settings and parameters, to and from your PC disk media. To better understand the structure, we recommend that you read this section if you anticipate that you'll need to isolate some, or all, of the individual parameters for later use. Note that all six file types are only available in **Expert Mode**, in order to reduce complexity for users who do not need this granular level of file storage.

The six file types are described below. Note that **Venue Project** is at the top of the hierarchy because it saves and recalls *all* parameters and settings of *all* the dSPEC's in your system.

- **Venue Project (.dvp)**
 - **Device File (.dev)** - *only available in Expert Mode*
 - **Preset File (.dps)** - *only available in Expert Mode*
 - **Speaker Tuning File** (Factory Defined .dtf, or User Defined .dtu)
 - **Amplifier Gain File (.agf)**.

A **Venue Project (.dvp)** is the root file type. It is the simplest and most important file, and in many cases the only file you will need to **Save** or **Open**. At least one .dvp file should always be saved for each **Venue Project**, otherwise the settings and parameters that you've established will not reside on disk, but only in dSPEC hardware. As previously mentioned, a **Venue Project** is the project you're working on and will always consist of at least *one* dSPEC, and possibly many more dSPECs.

A **Venue** project contains all of the parameters and settings for a given installation. It includes all of the data needed to fully **Save** and **Load** a **Venue Project** from the other file types. You can access **New Venue**, **Open Venue** and **Save Venue** from the drop down menu that appears on the **Task Bar** at the top of the screen in all of the five Main Screen Tabs. You can also use the shortcuts **Ctrl+N**, **Ctrl+O**, and **Ctrl+S** for convenience, instead of selecting from the drop-down menu.

As with any software, it's always prudent to **Save** your work often. Your computer might develop a problem; a power outage may occur; other unforeseen difficulties could arise. Resyn is no exception to this rule. We recommend that you **Save** a **Venue** file whenever you make important changes to your work that would be time-consuming to replicate later.

Even if you have no need to **Save** or **Recall** individual parameters and settings, we recommend that you *always* **Save** a **Venue** file so that you can load the parameters and settings that you've established to another dSPEC unit, at a later date, if you need to.



Resyn provides additional file types so that individual elements of a **Venue Project** can be **Saved to disk** and **Opened from disk** of any dSPEC whether it's related to the current project, or intended to be used later in a different project. The file types are described below:

Amplifier Gain File (.agf). An Amplifier Gain File contains input sensitivity and gain information of each amplifier that you've defined in your system, as well as any notes that you may have entered. These .agf files can be saved for use at a later date in other projects, or transferred to other dSPECS in the same project.

Speaker Tuning File (Factory Defined (.dtf) or User Defined (.dtu)). These files contain all of the active settings for each *DSP Processing Output* and are defined by the requirements of the Speaker that was selected. In the case of a *Factory Defined* file, all the work has already been done for you at the factory. In such case, each .dtf file will contain low and high pass filter data, corrective equalization settings, limiter settings, driver power handling data, and Uniform Response filter coefficients. If the selected Speaker is multi-amped (biamped, tri-amped, or other), the .dtf Speaker File will also contain the settings needed to configure the proper number of outputs along with the crossover data.

Conversely, if it's a .dtu *User Defined* file, it will contain all of the settings that you have manually entered. A user defined file can be a file that you have created from scratch - or it can simply be a modification of a factory file that you are using to save your own preferred settings.

Preset File (.dps) A **Preset File** contains a snapshot of all the active settings and parameters that are stored in only *one* specific **Preset** of only *one* specific dSPEC. It permits you to transfer a snapshot of a single **Preset** from one dSPEC unit to another.

Device File (.dev) A **Device File** contains all settings and parameters for a given dSPEC. It is typically used for transferring all settings and parameters and *Presets* from one dSPEC to another.

The default location for user files is C:\Documents and Settings\COMPUTER USER'S NAME\My Documents\Resyn.

APPENDIX B

DSPEC CONFIGURATION OPTIONS

Community dSPEC hardware devices may be ordered in the following configurations:

- **dSPEC226:** 2 IN x 6 OUT, the base model.
- **dSPEC226AN:** Includes an Input Expansion Card with 2 additional analog signal inputs for a 4 IN x 6 OUT configuration.
- **dSPEC226AE:** Includes an AES3 Input Expansion Card with 4 additional AES3 signal inputs for a 6 IN x 6 OUT configuration.

If you need to upgrade to a new model configuration in the field, please contact the factory.

IMPORTANT! As described in detail elsewhere in this Reference Manual, all dSPEC models are based on an internal 4 x 6 Input/Output *fixed architecture*. So while you can add Inputs and Outputs via expansion cards – up to 6 x 6 with the AES3 option – the internal 4 x 6 processing architecture determines the maximum number of unique Inputs and unique Outputs that you can use at any one time.

APPENDIX C

DSPEC EXTERNAL CONTROL PORT CONNECTION

Control Ports

All models and configurations of dSPEC include six (6) External Control Ports. Each of the six individual Ports can be used to remotely activate a user defined **Preset** by means of an external switch closure, or they can be used with a remote level control (*but not both at once*). The choice of how a Control Port is utilized is made in Resyn's Control screen on your computer. User defined **Presets** are always *created* in Resyn, but can be activated by means of the External Control Ports without requiring a computer to be connected to dSPEC.

OF INTEREST: Community provides a selection of Switches, Volume Controls and Wall Panels available optionally for use with dSPEC.

Control Ports are identified by their connection pins on the rear panel of dSPEC. The pins are labeled 1 – 6. Additionally, there are two Ground pins labeled "GND" and two Reference Voltage pins labeled "REF." All connections are made by means of a 10 pole detachable Euro-block terminal connector.

When a Control Port is assigned and used as a **Preset**, the **Preset** associated with that Control Port pin will be activated whenever a pin is pulled to ground, either momentarily or continually. This means that you can use momentary push buttons to permit **Preset** activation from more than one location, or you can use steady-state switches to insure that a **Preset** will be automatically activated following a power-down cycle. For your convenience, each control pin provides its own voltage source and only needs to be connected to GND to activate its associated Preset.

In addition to using the six Control Ports to activate **Presets**, one (or all) of the ports can instead be used with a potentiometer to function as a remote level control. You can choose whether an individual Control Port will function as a Preset Button or as a Level Control, by assigning the desired function in Resyn's Control Screen. When you open Control screen you'll see that initially each of the six Control Ports default to *Unassigned* with a drop-down arrow on the right. From the drop-down box you then select *Level Control*, *Preset Button*, or *Unassigned* (note: *Unassigned* simply cancels any previous assignment made to that particular port).

If you select *Preset Button*, a sub-menu will appear with the names of any previously created Presets. You must first *create* a Preset before you can *assign* that Preset to a Control Port. If no Presets have been created, the *Preset Button* will be grayed out and cannot be selected.

After creating one or more Presets, you can now click on a Preset name and that Preset will be assigned to any one (or more) of the six connection Pins that you choose. An indicator will appear to the right of the drop-down box that turns green whenever that Preset has been activated.

If you assign a Control Port to be used with a **Level Control** instead of a **Preset Button**, three new controls will appear directly to the right of the assignment boxes. These permit you to establish a minimum level, a maximum level, and to monitor the level that's set by the remote Level Control. The icons are labeled: (-) Range, (+) Range, Level. Note that you cannot *adjust* Level directly from Resyn on this screen (you can still adjust absolute levels on the Enhance screen), but you can *monitor* Level.

Level changes are intended to be made from the Remote Level Control. Level changes made via the Remote Level Control are relative to the *absolute levels* set on the Enhance screen. For example, if the volume on the enhance screen is set to +3dB and the external volume range is set to -3dB and +3dB, respectively, then the Remote Level Control will modify the absolute volume level in the range of 0dB to +6dB. If the volume on the enhance screen is changed to +6dB and the range for the Remote Level Control remains at +/- 3dB; the remote Level Control will modify the absolute level in the range of +3dB to +9dB.

When you program a Control Port to be used with a Remote Level Control, another button appears labeled "Calibrate Knobs." By clicking on it, a calibration screen tells you to turn each of the knobs to their minimum and maximum settings several times. This lets dSPEC calculate the resistance in each potentiometer and its connection cable, and then calibrate each of the Level Controls for optimal performance.

Below are some useful bits of information when using External Control:

The maximum allowable voltage on any Control Port pin is 5.3 VDC. Since presets are activated by a pull to ground this is not accurate. It would be accurate for some future function that we are not currently using.

Twisted pair cable is recommended for noise immunity. The Data Sheets that describe the use of our optional Preset Switch Assemblies and optional Remote Level Controls provide information regarding acceptable cable types, along with several different manufacturers' catalog numbers.

Very long cable lengths can be used with dSPEC's External Control Ports. If your facility has its own zip code, well you're in luck. dSPEC was designed to serve the needs of airports, conventions centers, stadia, theme parks, and other facilities that are sometimes spread out over large areas.

Multiple dSPECs can be controlled from a single switch or volume control. In such case, the dSPEC pins should simply be wired together in parallel. **Additionally the GND pins from each dSPEC control port should be wired together but the REF pin should only be used to supply potentiometer end voltage from 1 dSPEC.**

If more than one contact closure is made simultaneously, the lowest number pin takes precedence.

Remote Level Control Using Potentiometers

The dSPEC Control Port isn't as picky as your child's eating habits, but it inherently prefers linear taper 5-20 k Ω potentiometers. They'll provide a nice audio taper "feel" for the end user. When connected with suitable twisted pair wiring, the 20 k Ω value provides proper noise immunity, even with very long cable lengths (note: audio is not passing through the cable, only a control voltage).

Example of one (1) dSPEC unit with one (1) RLC1 Level Control and one (1) RPS4 Preset Recall Switch

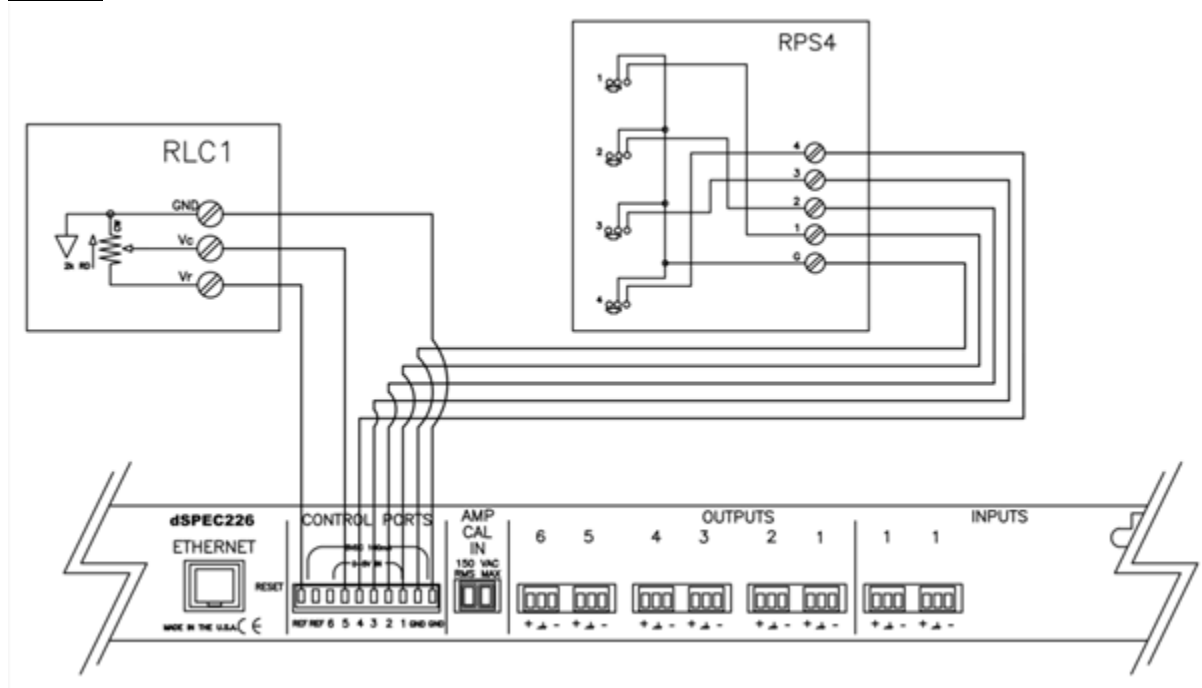

Example of four (4) dSPEC units controlled by one (1) RLC1 Level Control and one (1) RPS4 Preset Recall Switch

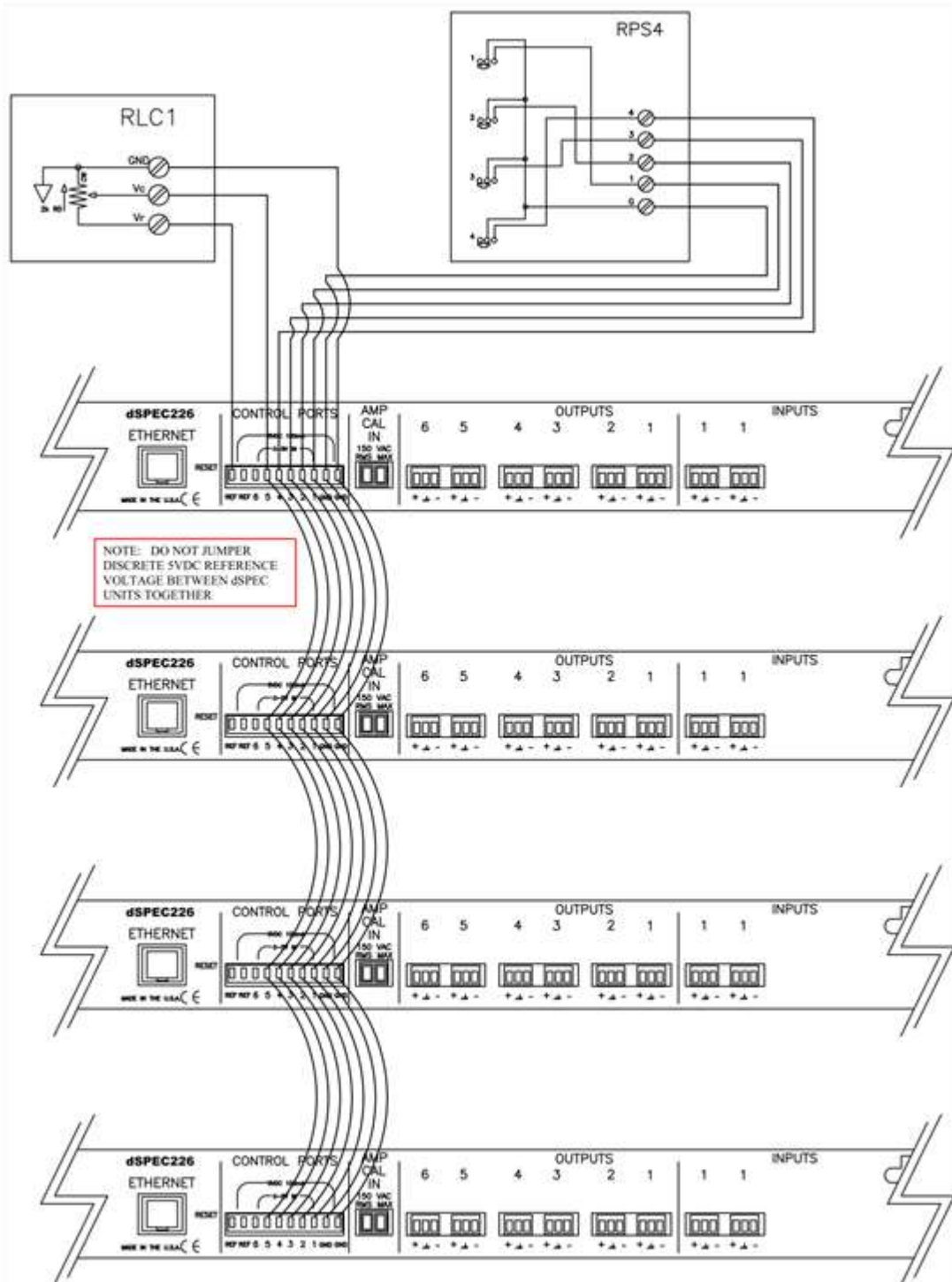

APPENDIX D

DSPEC HARDWARE - FRONT AND REAR PANEL VIEWS

dSPEC FRONT PANEL

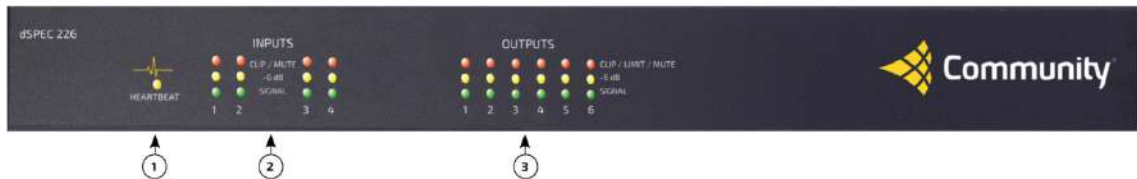

1. Heartbeat flashes to indicate that dSPEC is functioning. Alterations in the speed or pattern can assist in troubleshooting problems that arise.
2. Input LEDs indicate Signal Presence, Input Clipping, and Mute state.
3. Output LEDs indicate Signal Presence, Output Clipping, and Mute state.

dSPEC REAR PANELS

dSPEC226

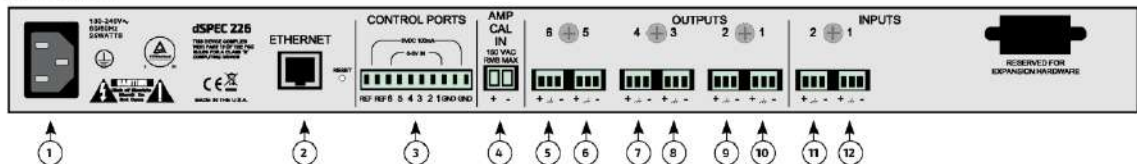

1. AC Mains Inlet (100-240VAC 50/60 Hz 25W)
2. Ethernet connection.
3. Control Ports for 6 remote switches or 6 volume knobs (any combination).
4. AMP CAL IN Port for setting protective limiter levels.
- 5 - 10. Balanced line Analog Outputs.
- 11, 12. Balanced line Analog Inputs.
13. Expansion Port accepts 2 additional Analog Inputs, or 4 AES3 Digital Inputs.

dSPEC226AN

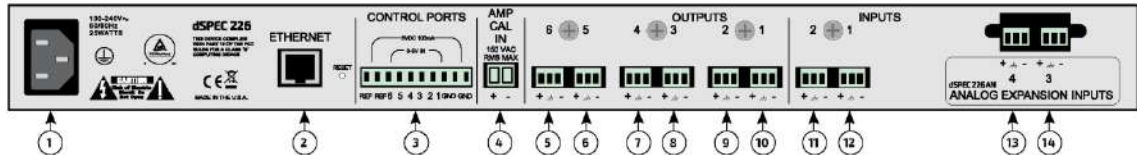

1. AC Mains Inlet (100-240VAC 50/60 Hz 25W)
2. Ethernet connection.
3. Control Ports for 6 remote switches or 6 volume knobs (any combination).
4. AMP CAL IN Port for auto-setting protective limiter levels.
- 5 - 10. Balanced line Analog Outputs.
- 11, 12. Balanced line Analog Inputs.
13. Added Balanced line Analog Input #4.
14. Added Balanced line Analog Input #3.

dSPEC226AE

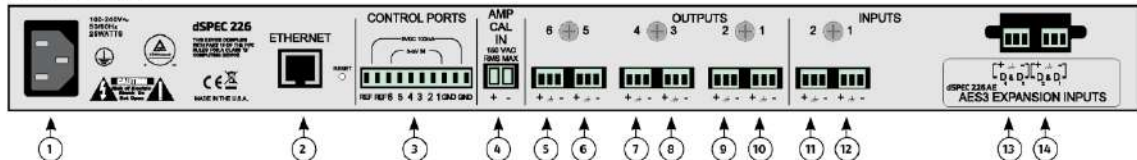

1. AC Mains Inlet (100-240VAC 50/60 Hz 25W)
2. Ethernet connection.
3. Control Ports for 6 remote switches or 6 volume knobs (any combination).
4. AMP CAL IN Port for auto-setting protective limiter levels.
- 5 - 10. Balanced line Analog Outputs.
- 11, 12. Balanced line Analog Inputs.
13. AES3 Digital Inputs 3 & 4.
14. AES3 Digital Inputs 1 & 2.



Community Professional Loudspeakers

333 East Fifth Street

Chester, PA 19013-4511 USA

Phone: (610) 876-3400 Fax: (610) 874-0190

www.communitypro.com

© 2015 *All Rights Reserved*

112057-MAN 28JUL2015