

ALLEN & HEATH

Allen & Heath Limited
 Kernick Industrial Estate
 Penryn, Cornwall,
 TR10 9LU, UK
www.allen-heath.com

Technical Datasheet

Overview

- Compatible with dLive, Avantis, SQ and AHM-64
- 16 Mic Preamps on XLR
- Phantom Power LED per Input
- 8 XLR Line Outs
- DX A connection with locking Ethercon port
- DX B locking Ethercon port for daisy chaining or redundancy
- Rubber bumpers
- Carry handle
- Optional rack mount kit available

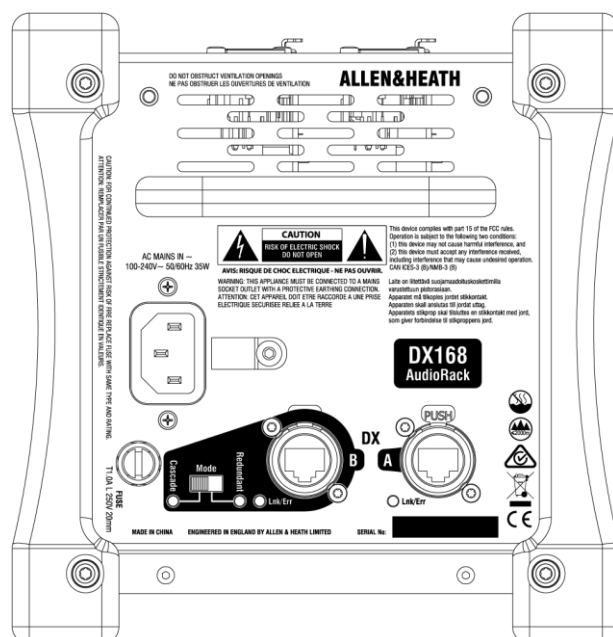
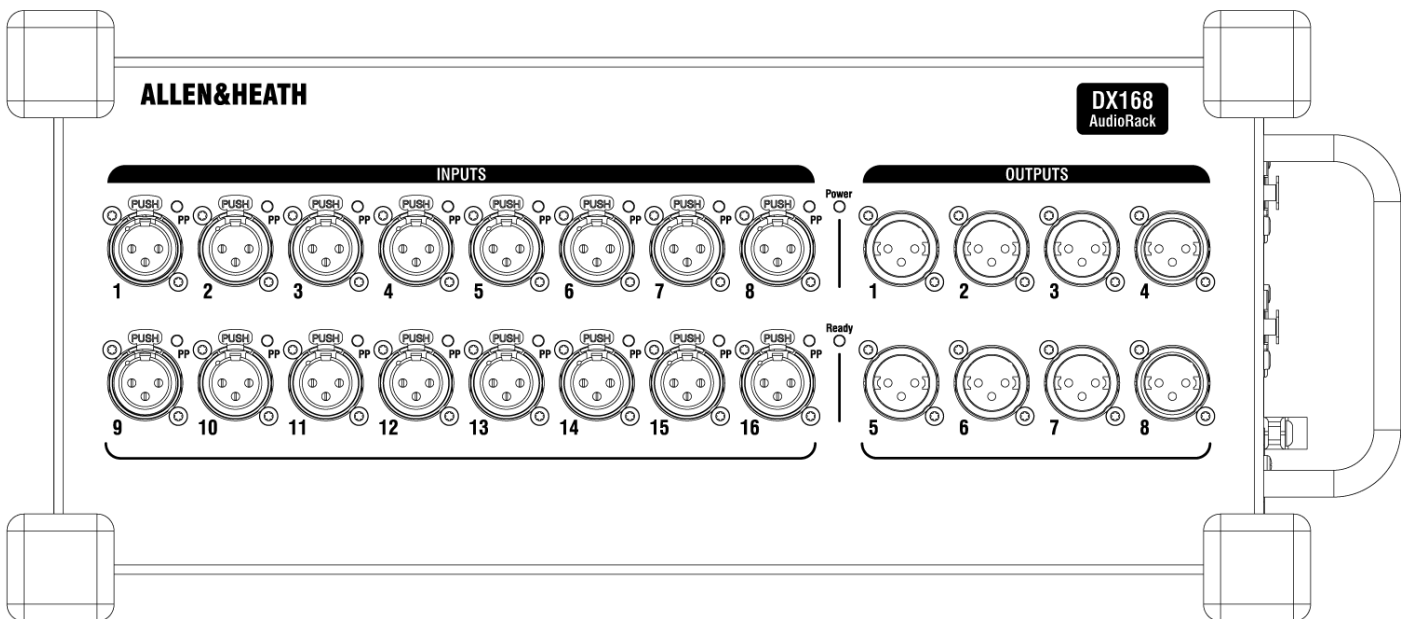

Dimensions

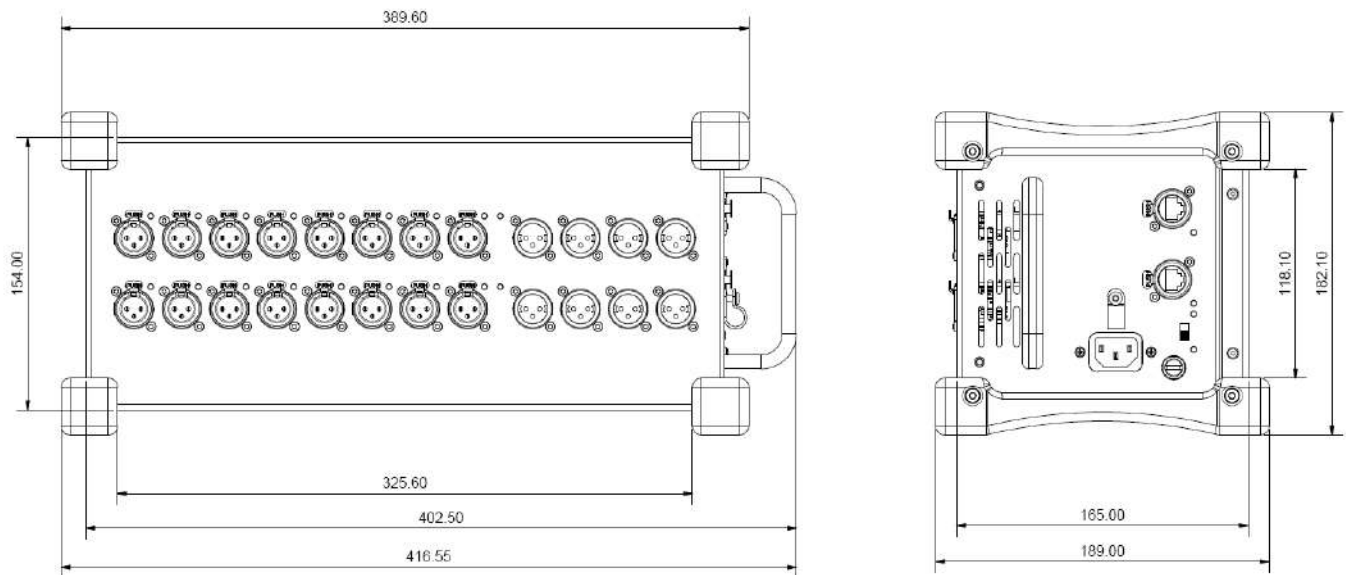

A&E Specifications

The unit shall be a portable remote audio device for dLive, Avantis, SQ and AHM-64 mixing systems. The remote audio unit shall provide 16 XLR inputs with individually configured Phantom Power and 8 XLR outputs. Phantom power LED indicators shall be provided per input socket on the remote audio rack.

Two Ethercon DX link connectors shall be provided for transport of the digital audio and control signals. The unit shall be able to operate in 'redundant' or 'cascade' mode by means of a mechanical switch. In 'redundant' mode the unit shall provide full redundant connection to a dLive S Class Surface or Mixrack. In 'cascade' mode the unit shall allow series connection of two units with a single cable connection to the dLive, Avantis, SQ or AHM-64 mixing system.

The Ethernet protocol shall provide control to the remote preamp, and all mic preamps are scene recallable by the digital mixing system. Unit firmware shall automatically be updated when connected to the digital mixing system.

The remote audio rack shall have a robust steel chassis and shall be designed to be portable and to be placed

horizontally or vertically on the stage or performance environment.

A carrying handle shall be provided to facilitate lifting and holding the device when moving and an optional padded dust cover shall be available.

The remote audio rack shall also be mounted in a 19" equipment rack or case using an optional remote audio rack kit.

The remote audio rack shall have a built-in power supply accepting AC mains voltages of 100~240V, 50/60 Hz, 35W max via an earthed 3-pin IEC male connector mounted on the rear chassis.

Recommended operating temperature for the remote audio rack shall be 0 to 35 degrees Celsius.

The unit shall be the Allen&Heath DX168.

System Specifications

Inputs

XLR Mic/Line Inputs	Balanced, +48V Phantom Power
Mic/Line Preamp	Fully recallable
Input Sensitivity	-60 to +15dBu
Analogue Gain	+5 to +60dB, 1dB steps
Pad	-20dB Active PAD
Maximum Input Level	+30dBu (PAD in)
Input Impedance	>4k Ω (Pad out), >10k Ω (Pad in)
Mic/Line Channel noise	22-22kHz, Direct Out @ unbalanced out
Mic EIN	-127dB with 150 Ω source
Unity gain (Pad in)	-90dBu
Low gain (5dB, Pad out)	-96dBu
Mid gain (30dB, Pad out)	-90dBu
Mic/Line Channel THD+N	22-22kHz, Direct Out @ unbalanced out
Unity gain (Pad in)	0.003% -88dBu @ 1kHz, 0dBu output
Low gain (5dB, Pad out)	0.002% -93dBu @ 1kHz, 0dBu output
Mid gain (30dB, Pad out)	0.003% -88dBu @ 1kHz, 0dBu output
Sample Rate	96kHz

Outputs

XLR Outputs	Balanced, Relay protected
Output Impedance	<75 Ω
Nominal Output	+4dBu = 0dB meter reading
Maximum Output Level	+22dBu
Residual Output Noise	-92dBu (muted, 20-20kHz)
Operating Temperature	0 deg C to 35 deg C (32 deg F to 95 deg F)
Mains Power	100-240V, 50/60 Hz, 40W max
Dimensions and Weight	Width x Depth x Height x Weight 410mm x 190mm x 185mm x 4.6kg (16.1" x 7.5" x 7.3" x 10.1lbs)