

GX4816 Technical Datasheet

Overview

- 48 Mic Preamps on XLR
- Phantom Power LED per Input
- 16 XLR Line Outs
- GX connection with locking Ethercon port
- DX ports for further I/O expansion
- DX 2 port compatible with ME system
- 96kHz audio

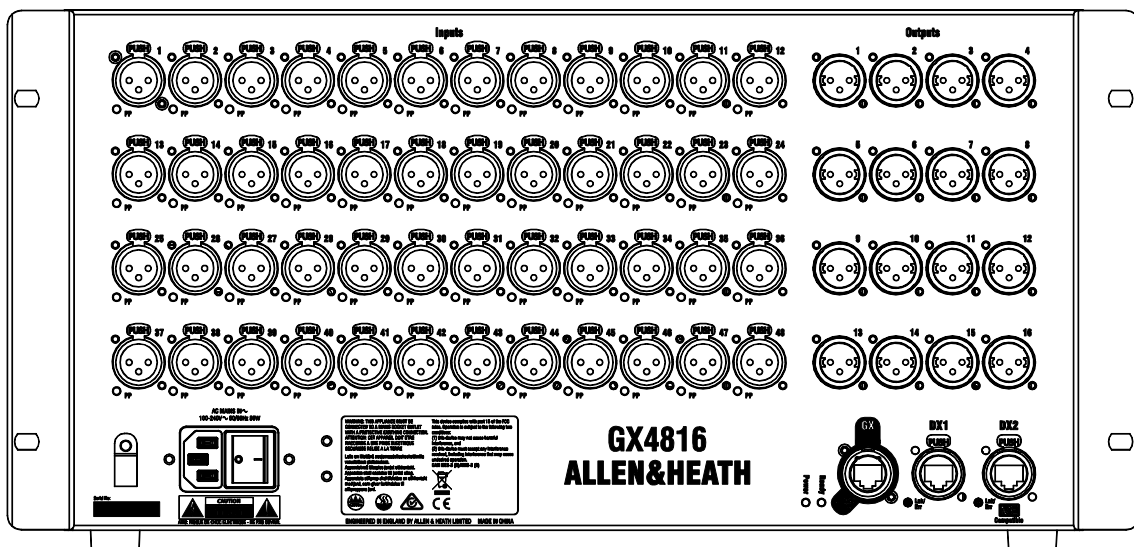

A&E Specifications

The unit shall be a rack-mountable remote audio device for Allen & Heath mixing systems. The remote audio unit shall provide 48 XLR inputs with individually configured Phantom Power and 16 XLR outputs. Phantom power LED indicators shall be provided per input socket on the remote audio rack. The unit shall work at 96kHz sampling rate.

One Ethercon connector shall be provided for transport of the digital audio and control signals to and from the mixing system. Two further Ethercon connectors shall be provided for further expansion with compatible Allen & Heath remote audio devices. One of these ports shall be compatible with the Allen & Heath ME personal mixing system.

The Ethernet protocol shall provide control to the remote preamp, and all mic preamps shall be recallable by the digital mixing system. Unit firmware shall automatically be updated when connected to the digital mixing system.

The remote audio rack shall have a built-in power supply accepting AC mains voltages of 100~240V, 50/60 Hz, 80W max via an earthed 3-pin IEC male connector on the front panel.

Recommended operating temperature for the remote audio rack shall be 0 to 40 degrees Celsius.

The unit shall be the Allen & Heath GX4816.

Dimensions

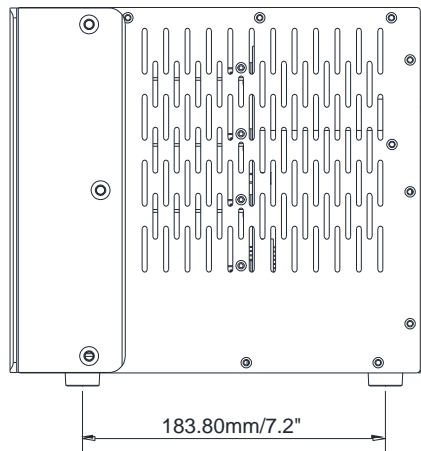
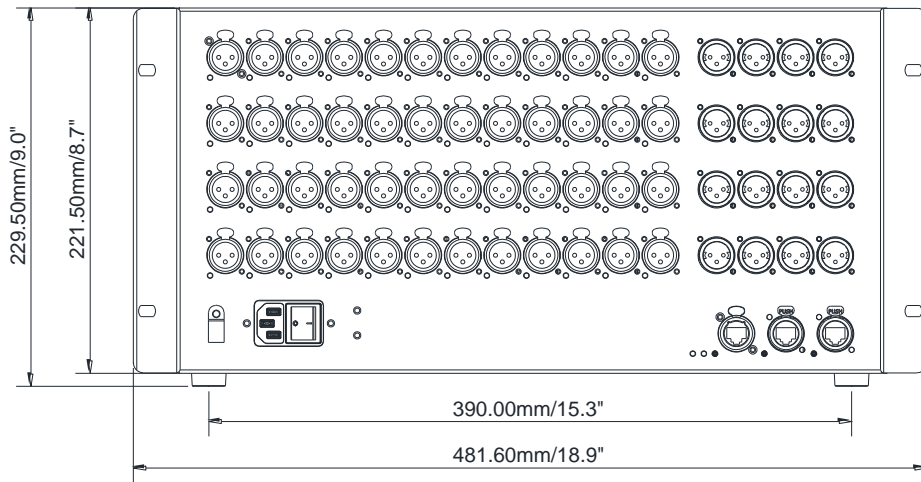
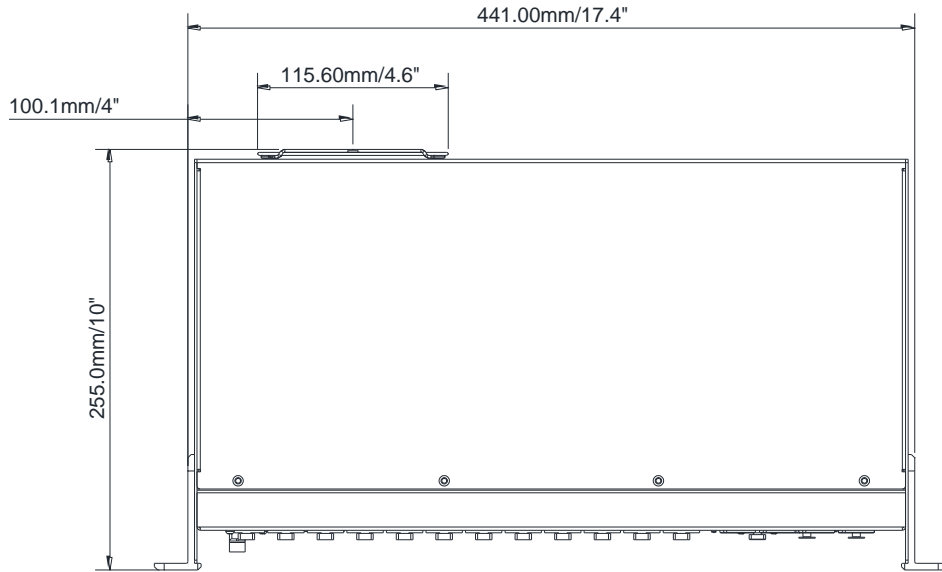

System Specification

Inputs

Mic/Line XLR Inputs	Balanced XLR, +48V phantom power
Mic/Line Preamp	Fully recallable
Input Sensitivity	-60 to +15dBu
Analogue Gain	+5 to +60dB, 1dB steps
Pad	-20dB Active PAD
Maximum Input Level	+30dBu (PAD in)
Input Impedance	>4k Ω (Pad out), >10k Ω (Pad in)
Mic EIN	-127dB with 150 Ω source
Phantom Power indication	Per socket, internal or external phantom power sensing, triggered at 24V

Power

Mains Voltage Operating Range	100-240V AC, 50/60Hz
Mains Power Consumption	80W max

Dimensions and Weights

Width x Depth x Height x Weight

GX4816	481.6 x 255 x 229.5 mm x 8kg (18.9" x 10" x 9" x 17.6lbs)
GX4816 (boxed)	560 x 385 x 310 mm x 10kg (22" x 15.2" x 12.2" x 22lbs)

Outputs

Analogue XLR Outputs	Balanced, Relay protected
Output Impedance	<75 Ω
Nominal Output	+4dBu = 0dB meter reading
Maximum Output Level	+21dBu
Residual Output Noise	-95dBu (muted, 22Hz-22kHz)

Temperature

Operating Temperature Range	0°C to 40°C (32°F to 104°F)
-----------------------------	-----------------------------