



**ALLEN & HEATH**



## **Personal Mixer Hub**

# **User Guide**

Publication AP9209

## **Limited One Year Manufacturer's Warranty**

Allen & Heath warrants the Allen & Heath -branded hardware product and accessories contained in the original packaging ("**Allen & Heath Product**") against defects in materials and workmanship when used in accordance with Allen & Heath's user manuals, technical specifications and other Allen & Heath product published guidelines for a period of ONE (1) YEAR from the date of original purchase by the end-user purchaser ("**Warranty Period**").

This warranty does not apply to any non-Allen & Heath branded hardware products or any software, even if packaged or sold with Allen & Heath hardware.

Please refer to the licensing agreement accompanying the software for details of your rights with respect to the use of software ("EULA").

Details of the EULA, warranty policy and other useful information can be found on the Allen & Heath website: [www.allen-heath.com/legal](http://www.allen-heath.com/legal).

Repair or replacement under the terms of the warranty does not provide right to extension or renewal of the warranty period. Repair or direct replacement of the product under the terms of this warranty may be fulfilled with functionally equivalent service exchange units.

This warranty is not transferable. This warranty will be the purchaser's sole and exclusive remedy and neither Allen & Heath nor its approved service centres shall be liable for any incidental or consequential damages or breach of any express or implied warranty of this product.

### **Conditions Of Warranty**

The equipment has not been subject to misuse either intended or accidental, neglect, or alteration other than as described in the User Guide or Service Manual, or approved by Allen & Heath.

Any necessary adjustment, alteration or repair has been carried out by an authorised Allen & Heath distributor or agent.

The defective unit is to be returned carriage prepaid to the place of purchase, an authorised Allen & Heath distributor or agent with proof of purchase. Please discuss this with the distributor or the agent before shipping. Units returned should be packed in the original carton to avoid transit damage.

**DISCLAIMER:** Allen & Heath shall not be liable for the loss of any saved/stored data in products that are either repaired or replaced.

Check with your Allen & Heath distributor or agent for any additional warranty information which may apply. If further assistance is required please contact Allen & Heath Ltd.



The ME range of products complies with the European Electromagnetic Compatibility directive 2014/30/EU and the European Low Voltage directive 2014/35/EU.

Any changes or modifications to the equipment not approved by Allen & Heath could void the compliance of the product and therefore the users authority to operate it.

ME-U Personal Mixing System Hub User Guide AP9209 Issue 3

Copyright © 2018 Allen & Heath. All rights reserved.

**ALLEN&HEATH**

<http://www.allen-heath.com>

## READ THESE INSTRUCTIONS FIRST:



### Safety instructions

Before starting, read the **IMPORTANT SAFETY INSTRUCTIONS** sheet supplied with the equipment and downloadable from the Allen & Heath web site. For your own safety and that of the operator, crew and performers, follow all instructions and heed all warnings printed in the sheet, this guide and on the equipment.



### General precautions

- The hub is designed to be rack mounted or used on a flat surface. Ensure it is securely positioned and cables are routed to avoid a trip hazard.
- To prevent damage to the equipment, avoid dropping it, placing objects on its surface, scratching the surface with sharp objects, or rough handling and vibration in operation or transit.
- Protect the equipment from damage through liquid or dust contamination.
- The hub has an internal fan and ventilation slots on the rear and sides to aid cooling. Ensure adequate ventilation around the equipment.
- Avoid operating the equipment in extreme heat or cold. Recommended operating temperature is 5 to 40 degrees Celsius.
- Clean the surface with a soft brush and dry lint-free cloth. Do not use chemicals, abrasives or solvents.
- It is recommended that servicing is carried out only by an authorised Allen & Heath agent. Allen & Heath do not accept liability for damage or data loss caused by maintenance, repair or modification by unauthorised personnel.



### Operating firmware

The function of the ME-U hub is determined by the operating firmware that runs within it. Firmware is updated when new features are added or improvements made. Check the Allen & Heath web site for the latest version available. This can be downloaded and then loaded into the ME-U hub using its Setup application.

By using this Allen & Heath product and the software within it you agree to be bound by the terms of the relevant **End User Licence Agreement** (EULA), a copy of which can be found at: [www.allen-heath.com/legal](http://www.allen-heath.com/legal).

**Note** – ME-1 mixers must be running firmware version V1.1 or higher to work correctly with the ME-U hub. Download the latest version from the Allen & Heath web site.



### Cables

Cat5 cables are required to connect the ME-U hub to ME mixers. These are not provided with the ME-U. Source cables of suitable length to meet your application requirements. More information is provided later in this guide.

Register your ME-U with Allen & Heath online at:

<http://www.allen-heath.com/support/register-product/>

# 1. Contents

1. Contents .....	4
2. Introduction to ME-U .....	5
3. Front Panel .....	6
4. Rear Panel .....	6
5. Installing ME-U .....	7
5.1 Rack or Surface Mount.....	7
5.2 Changing the Input Card.....	7
6. Connecting ME-U .....	8
6.1 Connecting the output ports .....	8
6.2 ME-1 parallel connection .....	8
6.3 ME-1 series connection.....	8
6.4 Linking ME-U hubs .....	8
6.5 Cat5 cables .....	8
6.6 Input source – Qu, SQ, GLD, dLive ..	9
6.7 Input source – iLive ACE .....	9
6.8 iLive via ME-U ACE card .....	10
6.9 Input source – iLive mixer MMO ....	10
6.10 Input source - Aviom® A-Net 16 .....	11
6.11 Input source – Other systems .....	11
7. Starting ME-U .....	12
8. Setting up ME-U .....	12
8.1 Setting the network addresses .....	12
8.2 Starting the Setup Application .....	12
8.3 Reset the ME-U network settings....	12
8.4 The Status page .....	13
8.5 System Setup page.....	14
8.6 Channel Setup page .....	15
8.7 Firmware page.....	17
8.8 To exit Setup.....	17
9. ME-U Specification.....	18
9.1 Dimensions .....	18
9.2 Specification .....	18
9.3 Further information .....	18

## 2. Introduction to ME-U



The **ME Personal Mixing System** is a uniquely flexible yet intuitively easy to operate solution giving individual musicians, performers and presenters the freedom to control their own monitor sound on stage.

### ME-1 Personal mixer

- Up to 40 channels
- User assignable keys
- Master limiter and 3-band EQ
- 16 User presets
- Group function
- Name display
- 3.5mm Jack Aux input
- Built-in ambient mic
- Built-in signal generator
- Includes stand bracket
- Includes headphone hook

### ME-500 Personal mixer

- Up to 16 mono/stereo channels
- Auto key assignment
- Master limiter and 2-band EQ
- 8 User presets

ME-500 and ME-1 mixers can be combined within the same ME system.

**ME-U** is a touring grade, 10 port PoE hub for use with Allen & Heath ME personal mixers. It provides power and up to 40 channels of audio to multiple ME-1 or ME-500 mixers. ME-U comes with a standard input card to interface with Allen & Heath digital mixers or Aviom® A-Net® sources. This card can be replaced with an option card to interface the ME with third party mixing systems.

### Features:

- 10 ports to connect ME-1 / ME-500
- Hubs can be linked for more ports
- Power (PoE) available on all ports
- Locking EtherCon connectors
- Standard ME-D input card works with
  - dLive ME monitor port
  - dSNAKE (Qu, SQ and GLD mixers)
  - ACE (iLive system)
  - Aviom® A-Net® 16
- Option cards to interface to other systems
  - Dante
  - MADI
  - EtherSound
  - Waves (V2 card)
- Network port for setup
- Names and stereo links can be received or manually set
- Rugged 2U rack mount construction
- Quiet fan cooling

### 3. Front Panel

**10 Output Ports** – To distribute audio and power to up to 10 ME-1 or ME-500 personal mixers. Can also connect to the input of another ME-U hub when connecting to more than 10 ME-1 mixers. Each port provides:

- Up to 40 channels of audio
- Channel names (ME-1 only)
- Channel stereo linking
- PoE power
- Locking EtherCon connection
- The ME-U outputs are compatible with the Allen & Heath ME system only.

**Input Port** – To receive sources to distribute to ME personal mixers. The ME-D input card is provided as standard. Several other option cards are available from Allen & Heath letting you interface the ME-U to other mixing systems: Dante, MADI, Waves SoundGrid, EtherSound.

- The ME-U input works with 48kHz 24-bit audio only.



An indicator next to each port lights yellow to show it is linked to its connection, and flashes to show network activity. It lights red during start up or when an error is detected.

**Network Reset** – A recessed switch for power up reset of the ME-U network address to factory default.

**ME-D** standard input card. The Lnk/Act indicator flashes when working with ACE or dSNAKE. It stays on when working with Aviom®.

**Network Port** – To connect a PC or Mac computer for system setup and channel naming.

### 4. Rear Panel

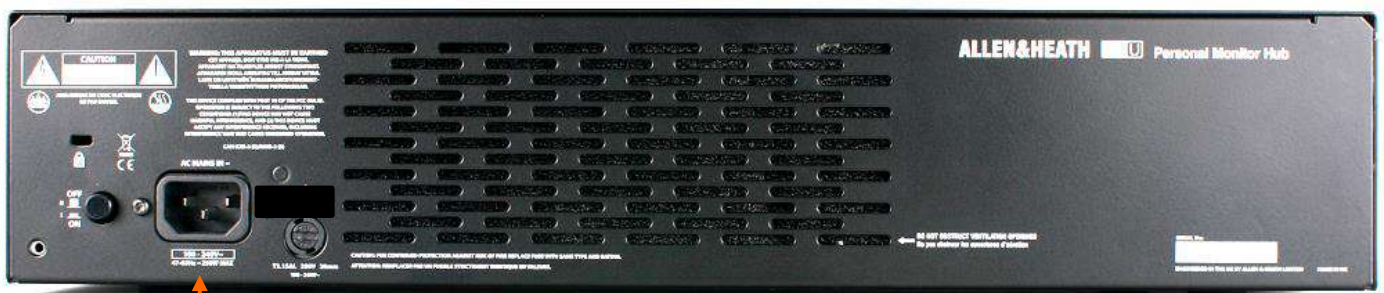

**Main Input** - IEC connector, fuse and ON/OFF push switch for the built-in universal voltage power supply unit. This accepts worldwide voltages from 100 to 240V AC 50/60Hz. Check that you have received the correct mains lead for your territory.

- Use the mains lead for your territory as supplied with the ME-U.
- Secure the mains lead using the plastic clip to prevent it being pulled out.
- Heed all the warnings printed in the Safety Instruction sheet and on the rear panel.
- To ensure adequate cooling do not obstruct the ventilation slots.

## 5. Installing ME-U

### 5.1 Rack or Surface Mount

ME-U can be positioned on a flat surface or mounted into a standard 19" equipment rack. It requires 2U rack space.

If necessary, remove the plastic feet by carefully prising them off using a flat bladed screwdriver.

Mount the ME-U in the rack using 4 rack bolts with protective washers to protect the panel.

- Ensure adequate ventilation around the unit. Do not block the ventilation slots.

- Make sure the ME-U is turned off before installing it or removing or fitting its Input card.

Rack bolts with protective cups or washers

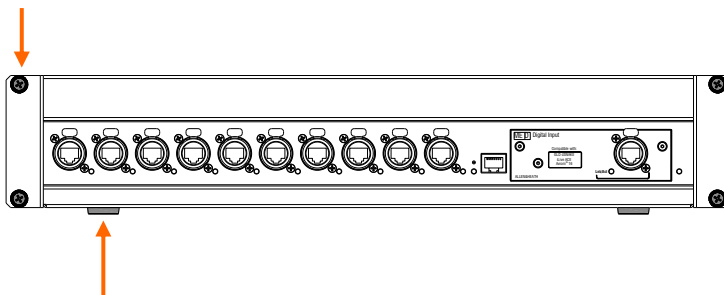

Plastic feet for surface mounting

### 5.2 Changing the Input Card

The Me-U is supplied with the ME-D Digital Input card as standard. This can be replaced with a different card if required.

**To replace the Input card:**

- First, turn the ME-U power off.
- Remove the two front fixing screws. Pull out the ME-D card and unplug the internal cable harness.
- Carefully fold the cable back into the slot. The replacement card does not use the internal cable harness.
- Slide the new card in and push it in until it clicks into the internal connector socket.
- Replace the two fixing screws.

**ME-D** Standard digital input card for connection to Allen & Heath digital mixers via dSNAKE or ACE, and to Aviom® A-Net16 sources.

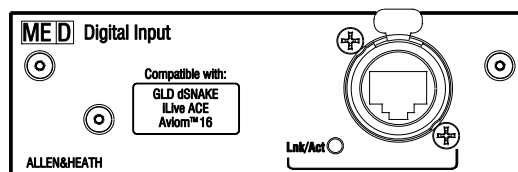

**Dante, EtherSound, Waves SG** To interface with other systems over Cat5 network protocols (48kHz).

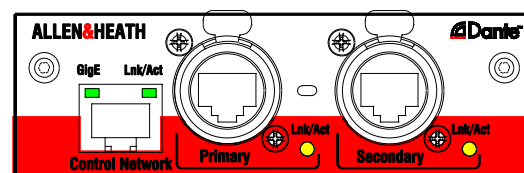

**MADI** To interface with other systems via MADI (48kHz).

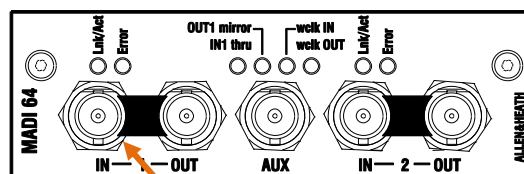

Use Link 1 In. ME-U will sync from the incoming MADI stream.

- The Aux BNC and MADI Link 2 are not operational in this application.

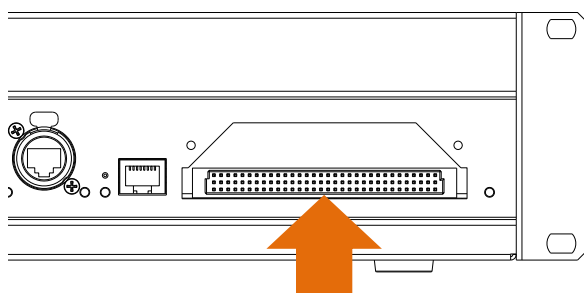
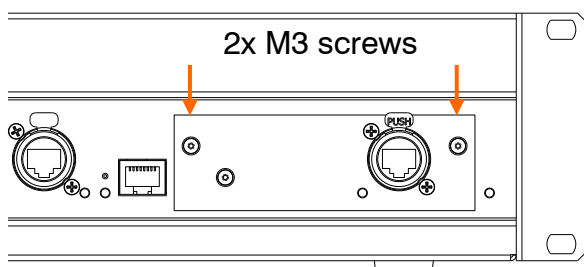

Slide card in to plug into connector

## 6. Connecting ME-U

### 6.1 Connecting the output ports

The ME-U output ports are for connection to Allen & Heath ME products only.

- Do not connect ME-U output ports to other mixers or equipment.

Connect each ME-U Output port to the Link In port of the ME-1 or ME-500 mixer.

- Each port can power one ME mixer. If you daisy chain mixers then power is fed to the first mixer only.

### 6.5 Cat5 cables

Use STP (shielded twisted pair) CAT5e or higher cables. Those with both foil and braided screens provide shielding from interference and are generally more rugged. Stranded core cables are less prone to damage when kinked or repeatedly coiled.

ME-U provides locking Neutrik EtherCon sockets to protect the connections and ensure suitability for touring. We recommend you use cables fitted with locking EtherCon plugs.

Maximum length per cable  
= 100m (330')



### 6.2 ME-1 parallel connection

You can connect up to 10 ME mixers each with their own Cat5 cable.

Each ME mixer is powered over its Cat5 cable. You do not need to use its power unit. Unplugging one ME mixer does not affect the others.

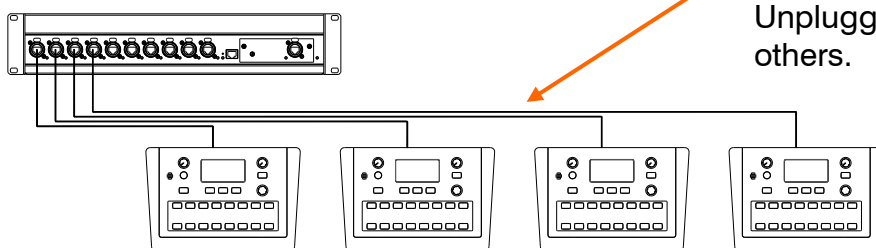

### 6.3 ME-1 series connection

You can daisy chain ME mixers from any port.

The first ME mixer in the chain gets PoE to power it over its Cat5 cable. Use external power units for the others in the chain. Unplugging one ME mixer disconnects others further down the chain.

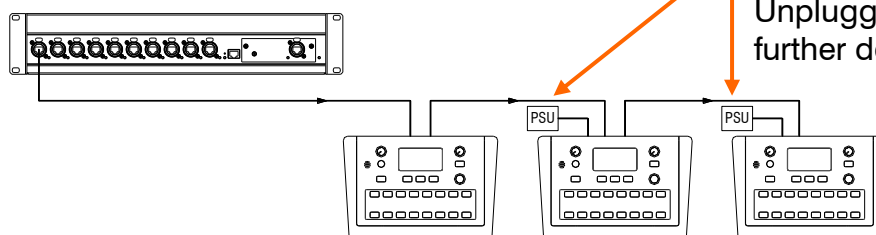

### 6.4 Linking ME-U hubs

You can link ME-U hubs to connect to more ME mixers.

Connect any Output port from the first ME-U to the Input port of the next ME-U.

Use the **first ME-U** hub Setup Application to set its names and stereo links. Tick the iLive Source Mode if connecting an iLive system.

Use the **next ME-U** hub Setup Application for received names and stereo links. Make sure you untick its iLive Source mode.

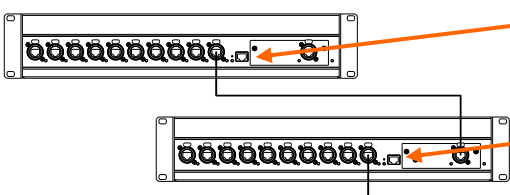



## 6.6 Input source – Qu, SQ, GLD or dLive

Plug any of these ports into the ME-D:

<b>GLD mixer</b>	dSNAKE port
	EXPANDER port
<b>Qu mixer</b>	dSNAKE port
<b>SQ mixer</b>	SLink port
<b>dLive MixRack</b>	ME Monitor port
<b>AR2412 rack</b>	MONITOR port
<b>AR2412 / AB168</b>	EXPANDER port

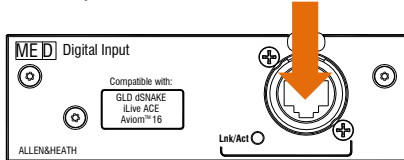

- Connection to 96kHz DX Expanders is not supported.

Qu, SQ, GLD and dLive can send:

- 40 audio channels
- Channel names
- Stereo link information

✓ = Available  
✗ = Not available

Use the **ME-U Setup Application**:

- Received names and stereo links ✓
- Manual names and stereo links ✓
- iLive Source Mode ✗ (turn this off)

Use the **Qu Setup / Output Patch / Monitor** screen to assign the channels. Stereo sources and linked Input channels are automatically linked and presented to the ME-1 as stereo pairs.

Use the **SQ I/O / Outputs ME** screen to assign the channels. Stereo channels are automatically linked and presented to the ME-1 as stereo pairs.

Use the **GLD I/O / Monitor** screen to select 'ME-1 Mode', assign the channels and set the stereo links.

Use the **dLive I/O / ME** screen to assign the channels and set the stereo links.

## 6.7 Input source – iLive ACE

Using the standard ME-D input card.

Plug iLive ACE from the MixRack Port B.

- Do not use the MixRack surface link ACE.

To receive channel names you need to connect a second Cat5 cable from an iLive Network port into the ME-U Network port.

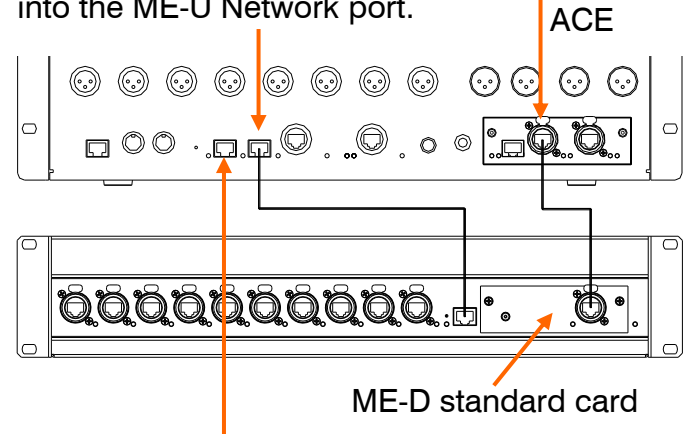

Plug your ME-U setup computer into any iLive Network port.

Using 1 cable only - ACE:

- 40 audio channels
- No channel names and link information

Using 2 cables – ACE and Network:

- 40 audio channels
- Channel names
- Stereo link information

Use the **ME-U Setup Application**:

- Received names and stereo links ✓
- Manual names and stereo links ✓
- iLive Source Mode ✓ (turn this on)
- Select iLive MixRack from list

Use the **iLive Outputs / Port B** screen to assign the 40 channel sources.

- Map Port B ACE outputs 21-60 to ME channels 1-40:

Port B Ch21 = ME Ch1  
 Port B Ch22 = ME Ch2  
 Port B Ch23 = ME Ch3  
 -----  
 Port B Ch60 = ME Ch40

## 6.8 iLive via ME-U ACE card

Using the ACE card option in the ME-U.

Plug iLive ACE from the MixRack Port B.

- Do not use the MixRack surface link ACE.

To receive channel names you need to bridge the iLive network across the ACE connection using two jumper cables as shown here.

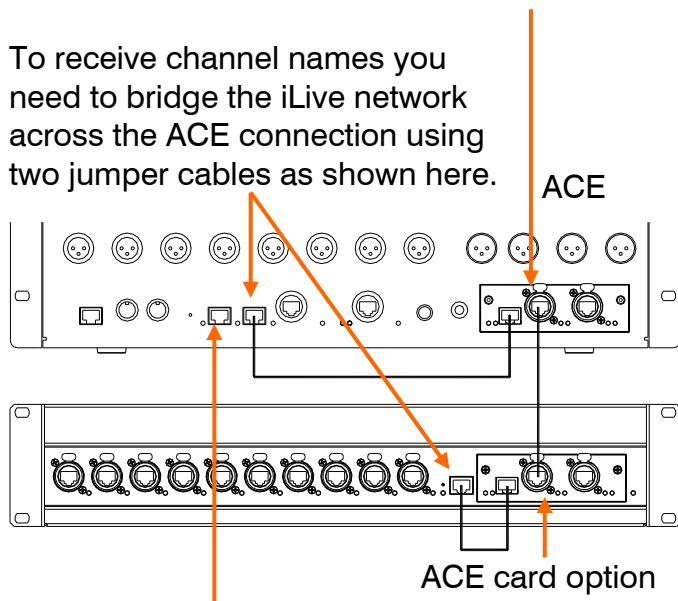

Plug your ME-U setup computer into any iLive Network port.

Without Network bridge:

- 40 audio channels
- No channel names and link information

With Network Bridge:

- 40 audio channels
- Channel names
- Stereo link information

Use the **ME-U Setup Application**:

- Received names and stereo links ✓
- Manual names and stereo links ✓
- iLive Source Mode ✓ (turn this on)
- Select iLive MixRack from list

Use the **iLive Outputs / Port B** screen to assign the 40 channel sources.

- Map Port B ACE outputs 1-40 to ME channels 1-40.

## 6.9 Input source – iLive mixer MMO

Using the standard ME-D input card.

iLive Port B MMO card Aviom® out

To receive channel names you need to connect a second Cat5 cable from an iLive Network port into the ME-U Network port.

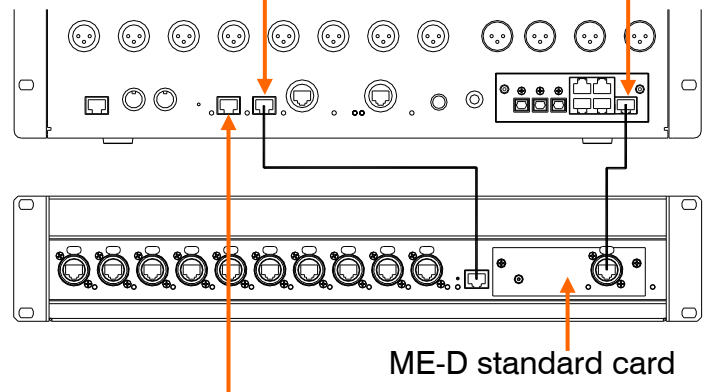

Plug your ME-U setup computer into any iLive Network port.

Using 1 cable only – Aviom®:

- 16 audio channels
- Stereo link information
- No channel names

Using 2 cables – Aviom® and Network:

- 16 audio channels
- Channel names
- Stereo link information

Use the **ME-U Setup Application**:

- Received names and stereo links ✓
- Manual names and stereo links ✓
- iLive Source Mode ✓ (turn this on)
- Select iLive MixRack from list

Use the **iLive Outputs / Port B** screen to assign the 16 Aviom® sources and links.

## 6.10 Input source - Aviom® A-Net 16

Using the standard ME-D input card.

- Use the ME-U to connect to ME-1 and ME-500 mixers only. It is not intended for nor compatible with Aviom® mixers.

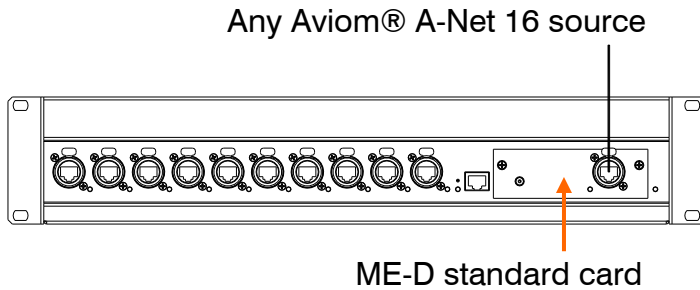

The Aviom® source can send:

- 16 audio channels
- Stereo link information

No channel names

Use the **ME-U Setup Application**:

- Received names ✘
- Received stereo links ✔
- Manual names and stereo links ✔
- iLive Source Mode ✘ (turn this off)

The ME-U gets its audio and link information from Aviom® channels 1-16.

## 6.11 Input source – Other systems

Fit a Dante, MADI, Waves SoundGrid (V2) or EtherSound card to interface other mix systems to the ME-U (48kHz only).

The source can send:

- Up to 40 audio channels

No stereo link information

No channel names

Use the **ME-U Setup Application**:

- Received names and stereo links ✘
- Manual names and stereo links ✔
- iLive Source Mode ✘ (turn this off)

Option card inputs 1-40 are used to feed the ME-1 or ME-500 mixers.

## 7. Starting ME-U

Connect to your mains power outlet and press the rear panel ON/OFF switch to turn the ME-U on.

The front panel blue power indicator lights. Wait until the ME-U has booted. This takes around 20 seconds. The Output Port indicators briefly flash red once the system has booted. With nothing connected they then turn off. With a ME-1 or ME-500 mixer connected they flash yellow.

## 8. Setting up ME-U

The ME-U is set up using a PC or Mac computer connected to the Network port. A setup application held within the ME-U is accessed using a web browser on the computer, similar to the method typically used to set up a wireless router.

Setup functions available:

- View and update the ME-U firmware
- View the unit operating temperature
- View the current input source
- View audio clock sync status
- View port link and PoE status
- Change the ME-U network settings
- Select name/link Source Mode (iLive)
- Choose the iDR MixRack (iLive)
- View and edit the 40 channel names
- View and edit the channel stereo links

Settings are stored in the ME-U and remembered on power up.

### 8.1 Setting the network addresses

Plug a Cat5 cable from your computer Network (LAN) port to the ME-U front panel Network port.

For the computer to communicate with ME-U it must have a compatible static TCP/IP address. Check that your computer LAN port is enabled with its DHCP turned off.

**Set a static computer IP address:**

IP address = 192.168.1.nnn

Subnet Mask = 255.255.255.0

Where nnn is between 1 and 254 (not 40)

**The default ME-U network address is:**

IP address = 192.168.1.40

Subnet Mask = 255.255.255.0

If this has been changed and is not known then it may be incompatible and the computer may not connect. If this is the case reset the ME-U network settings using the front panel recessed switch.

### 8.2 Starting the Setup Application

Start your computer web browser.

Enter the ME-U IP address into the browser address bar: 192.168.1.40

The computer should connect and display the Status page of the ME-U Setup Application.



### 8.3 Reset the ME-U network settings

If the computer fails to connect then try resetting the ME-U network settings:

Turn the ME-U off. Use a thin pointed object to press the recessed 'Reset' switch. Turn power back on and keep the switch pressed for 20 seconds while the unit reboots. This resets the ME-U network to:

IP address = 192.168.1.40

Subnet Mask = 255.255.255.0

Default Gateway = 192.168.1.254

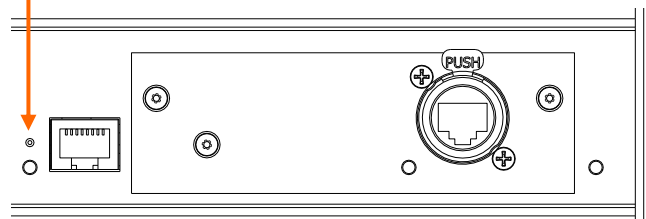

## 8.4 The Status page

The screenshot shows the Allen & Heath ME-U web interface. At the top, there are navigation tabs: Status, Channel Setup, System Setup, and Firmware. The Status page is active, showing a 'Sync complete' message. Below this, system information is displayed: Firmware: 1.00G - 12031, Temperature: 28°C, Audio Source: ME-D dSNAKE/ACE, Source Mode: iLive, and iDR Mix Rack: iDR Mix Rack. A 'Source Clock Sync' checkbox is checked. Below the system information is a table with 10 rows, each representing a port. The table has three columns: Port, Ethernet Linked, and PoE Active. Port 4 is highlighted in grey, and its 'Ethernet Linked' and 'PoE Active' checkboxes are checked. An orange arrow points to the 'Status' tab, and another orange arrow points to the 'Ethernet Linked' column header.

Port	Ethernet Linked	PoE Active
1	<input type="checkbox"/>	<input type="checkbox"/>
2	<input type="checkbox"/>	<input type="checkbox"/>
3	<input type="checkbox"/>	<input type="checkbox"/>
4	<input checked="" type="checkbox"/>	<input checked="" type="checkbox"/>
5	<input type="checkbox"/>	<input type="checkbox"/>
6	<input type="checkbox"/>	<input type="checkbox"/>
7	<input type="checkbox"/>	<input type="checkbox"/>
8	<input type="checkbox"/>	<input type="checkbox"/>
9	<input type="checkbox"/>	<input type="checkbox"/>
10	<input type="checkbox"/>	<input type="checkbox"/>

**Port Status** – Displays the current connection status of each of the 10 output ports:

**Ethernet Linked** – The box is ticked if a network connection to a ME-1 or ME-500 mixer has been recognised.

**PoE Active** – The box is ticked if the port is supplying power over the Cat5 cable to the ME-1 or ME-500 mixer.

This page shows information about the ME-U. It lets you check the current status of the hub, its input source and connected units:

**Firmware** – The current operating firmware running in the ME-U.

- Check the Allen & Heath web site for the latest version available.

**Temperature** – The current operating temperature measured inside the unit.

- If this reads higher than 40 degrees C then check that there is adequate airflow around the unit and that its ventilation slots are not blocked.

**Audio Source** – Displays the Input card type and information on the source connected to the ME-U. The following will display depending on input card fitted and source:

- ME-D dSNAKE/ACE
- ME-D Aviom® (Aviom source recognised)
- Dante Option Card
- MADI Option Card
- EtherSound Option Card
- ACE Option Card (not typical – use ME-D)

**Source Mode** – 'iLive' will appear if the ME-U has been set to work with iLive. In this mode the ME-U attempts to find channel names and stereo link information from the iLive.

- iLive mode should only be set if you are working with an iLive system. For all other sources turn this mode off using the System Setup page.

**iDR Mix Rack** – This displays the name of the unit the ME-U attempts to connect to when set to work with iLive. This information does not appear if iLive mode is turned off.

**Source Clock Sync** – The box is ticked if the ME-U audio clock has synchronised to the source.

## 8.5 System Setup page

ALLEN & HEATH  
MEU

Status Channel Setup **System Setup** Firmware

ME-U IP Settings:

IP Address: 192 168 1 40

Net Mask: 255 255 255 0

Default Gateway: 192 168 1 254

Host MAC Address: 00:04:c4:00:8b:48

dSNAKE MAC Address: 00:04:c4:00:8b:49

Source Mode:

iLive:

(read channel names and stereo links from iDR Mix Rack)

iDR Mix Rack Selection:

Found Units:

iDR Mix Rack: iDR Mix Rack

✓ Sync complete

If you make changes to the settings click 'Save' to confirm or 'Cancel' to restore the previous settings.

iDR Mix Rack: iDR Mix Rack

! Unsaved changes.

Use this page to access ME-U system settings:

**ME-U IP Settings** – Displays the current network static TCP/IP settings. You can change these if you wish to access the ME-U via a different network.

Default settings can be restored using the front panel recessed 'Reset' switch.

IP address = 192.168.1.40

Subnet Mask = 255.255.255.0

Default Gateway = 192.168.1.254

- If you are using the Network port to receive names from an iLive system then make sure the ME-U and iLive network addresses are compatible.
- If you are not sure how to set these settings then refer to your IT administrator.

**Host MAC Address** – This is the permanent address assigned to the ME-U hardware.

**dSNAKE MAC Address** – This is the permanent address assigned to the input card found in the Input Port.

**Source Mode** – If you are using ME-U with an iLive system and connecting its network to receive its names and stereo link status then tick the iLive mode box.

- If you are not connecting to an iLive system then make sure the box is not ticked. Failure to do so may result in the ME-U being unable to find names from the connected system.

**iDR Mix Rack Selection** – The 'Found Units' list shows any iDR racks found on the network. Choose the rack to connect to.

The 'iDR Mix Rack' box shows the name of the iLive iDR rack the ME-U looks for when starting.

This setting is only used if iLive Source Mode has been selected.

**Default** - Restores the factory default iDR Mix Rack name.

## 8.6 Channel Setup page

Use this interface to set the channel names and stereo link status to be broadcast to connected ME-1 mixers.

Check 'Use Received' boxes to use names and link status received from the input source.

Uncheck 'Use Received' boxes to use manually entered names and link status stored in the ME-U.

! Source Mode: iLive (read channel names and stereo links from IDR Mix Rack)

✓ Sync complete Defaults

Channel	Received		Use Received (All <input checked="" type="checkbox"/> )	Manual	
	Name	Stereo Link		Name	Stereo Link
1		<input type="checkbox"/>	<input checked="" type="checkbox"/>	1	<input type="checkbox"/>
2		<input type="checkbox"/>	<input checked="" type="checkbox"/>	2	<input type="checkbox"/>
3		<input type="checkbox"/>	<input checked="" type="checkbox"/>	3	<input type="checkbox"/>
4		<input type="checkbox"/>	<input checked="" type="checkbox"/>	4	<input type="checkbox"/>
5		<input type="checkbox"/>	<input checked="" type="checkbox"/>	5	<input type="checkbox"/>
6		<input type="checkbox"/>	<input checked="" type="checkbox"/>	6	<input type="checkbox"/>
7		<input type="checkbox"/>	<input checked="" type="checkbox"/>	7	<input type="checkbox"/>
8		<input type="checkbox"/>	<input checked="" type="checkbox"/>	8	<input type="checkbox"/>
9		<input type="checkbox"/>	<input checked="" type="checkbox"/>	9	<input type="checkbox"/>
10		<input type="checkbox"/>	<input checked="" type="checkbox"/>	10	<input type="checkbox"/>
11		<input type="checkbox"/>	<input checked="" type="checkbox"/>	11	<input type="checkbox"/>
12		<input type="checkbox"/>	<input checked="" type="checkbox"/>	12	<input type="checkbox"/>
13		<input type="checkbox"/>	<input checked="" type="checkbox"/>	13	<input type="checkbox"/>
14		<input type="checkbox"/>	<input checked="" type="checkbox"/>	14	<input type="checkbox"/>
15		<input type="checkbox"/>	<input checked="" type="checkbox"/>	15	<input type="checkbox"/>

This example shows no name and stereo link data received. This is the default on power up when no input is connected, or when you are working with a source that does not broadcast the channel data.

If you make changes to the settings click 'Save' to confirm or 'Cancel' to restore the previous settings.

! Unsaved changes Cancel Save Defaults

Channel	Received		Use Received (All <input type="checkbox"/> )	Manual	
	Name	Stereo Link		Name	Stereo Link

Some Allen & Heath digital mixers can broadcast their channel names and stereo link status to the ME-U for distribution to all connected ME-1 and ME-500 mixers:

**iLive** – Data is sent over an additional cable plugged from an iLive Network port into the ME-U Network port.

**Qu, SQ, GLD and dLive** – Data is sent over the Cat5 connection along with the audio into the ME-D input.

Odd/even channels can be linked at the source so that the ME mixers automatically link the two channels for stereo operation assigned to a single key.

Use this page to view and edit the names and stereo link status of the 40 audio channels sent to the 10 ME-U Output ports.

The page displays two main columns:

**Received** – Channel names and stereo link status received from the source. The list is blank if none are received.

- The ME-U remembers the last received settings, for example when the mixer is turned off or the ME-U input cable is unplugged. Reboot the ME-U if you wish to clear and refresh the received settings.

**Manual** – This column lets you manually enter channel names and select odd/even pairs to be stereo linked.

**Use Received** – Tick this box to use the names and link status received from the source. Untick the box to use the manually entered data. Tick individual channels or tick **All** at the top to affect all 40 channels.

**Sync** – ME-U checks every few seconds to update the list of received names and links displayed with those assigned at the mixer.

**Default** – Click to reset all the manual names to numbers 1-40, clear all stereo links and to set all channels to use received data.

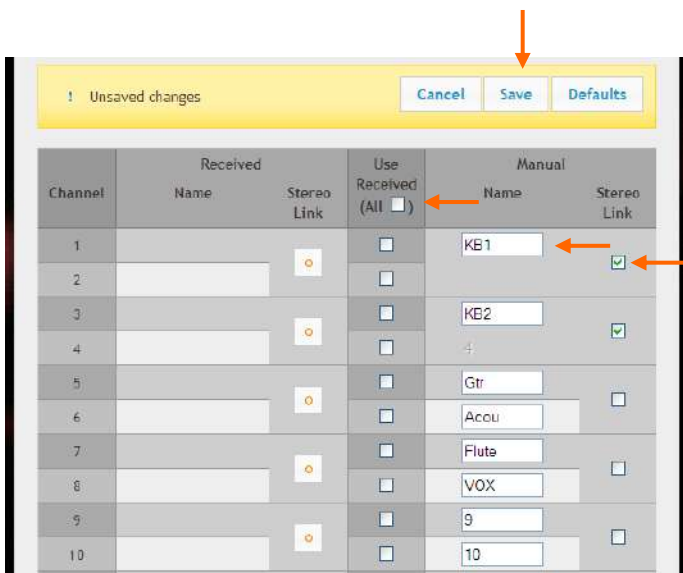

## Manual names and stereo links

If your source does not broadcast the channel data then you can manually enter names and stereo linking for the 40 channels. Tick and then untick the **(All)** box in the 'Use Received' column.

Click a **Name** box and type in a name with up to 6 characters. This is the name that will be displayed on the ME-1 mixer screen when its key is assigned for 'Default' name.

Tick the **Stereo Link** box for channels you wish to link, for example left and right of a stereo keyboard. Type a name for the linked channels into the top name box. The lower name box is disabled on linked channels.

If you make changes to the settings click 'Save' to confirm or 'Cancel' to restore the previous settings.

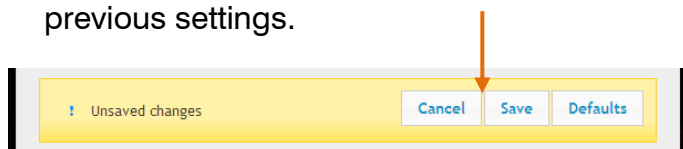

## Clearing names and links

Click **Defaults** to reset all manual names to their number 1-40 and all stereo links off. This also sets all channels to use received data.

You can use this to reset names and links as a starting point for entering manual names. In this case remember to untick the 'Use Received' boxes.



## Manually editing received names

You can use a combination of received and manual data.

This example shows names and stereo link status received from the input source, for example dLive or GLD.

The names are those assigned at the source mixing console.

Here, CH9 and 10 are linked for stereo operation at the ME mixers. In this case only one name is used.

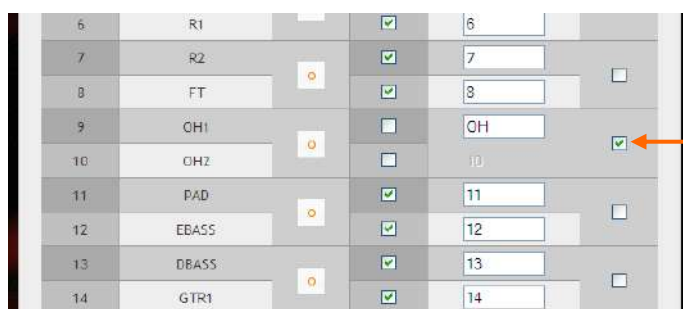

This example shows how you can edit some of the received names and stereo status to suit your ME personal mixing requirements.

Here, CH9 and 10 are manually edited to combine the two overhead drum mics as a stereo pair at the ME mixer.

Untick the two 'Use Received' boxes.



## 8.7 Firmware page

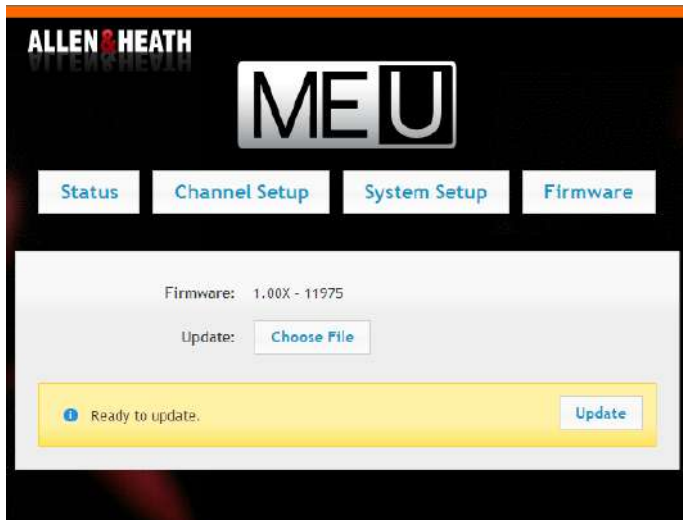

Use this page to update the ME-U operating firmware.

- Check the Allen & Heath web site for the latest version available. Read the firmware Release Notes.

**Firmware** – Displays the firmware version currently running on the ME-U.

**Choose File** – Click this button to browse the folders on your computer and choose the firmware file to load. The file has the following format, for example:

AllenHeathME-U\_V1.00-Rev12345.ulmage

### To update the firmware

Click the **Update** button to start the firmware update. It can take up to 6 minutes to complete.

- Do not turn the power off while the firmware is being updated.

When complete, click the **Continue** button. This will automatically restart the ME-U unit.

## 8.8 To exit Setup

Make sure you have saved any changes you have made to the ME-U. These settings are stored in the ME-U.

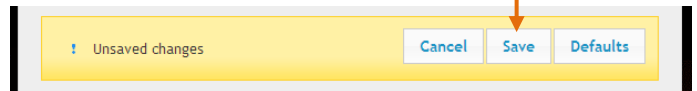

If you have changed the ME-U IP address then keep a note of this as you will need it next time you want to open the Setup Application.

To exit the Setup Application simply close the web browser.

You can disconnect your computer from the ME-U once setup is complete. The ME-U does not require a computer to run it. The computer is used only for setup and to view status.

## 9. ME-U Specification

### 9.1 Dimensions

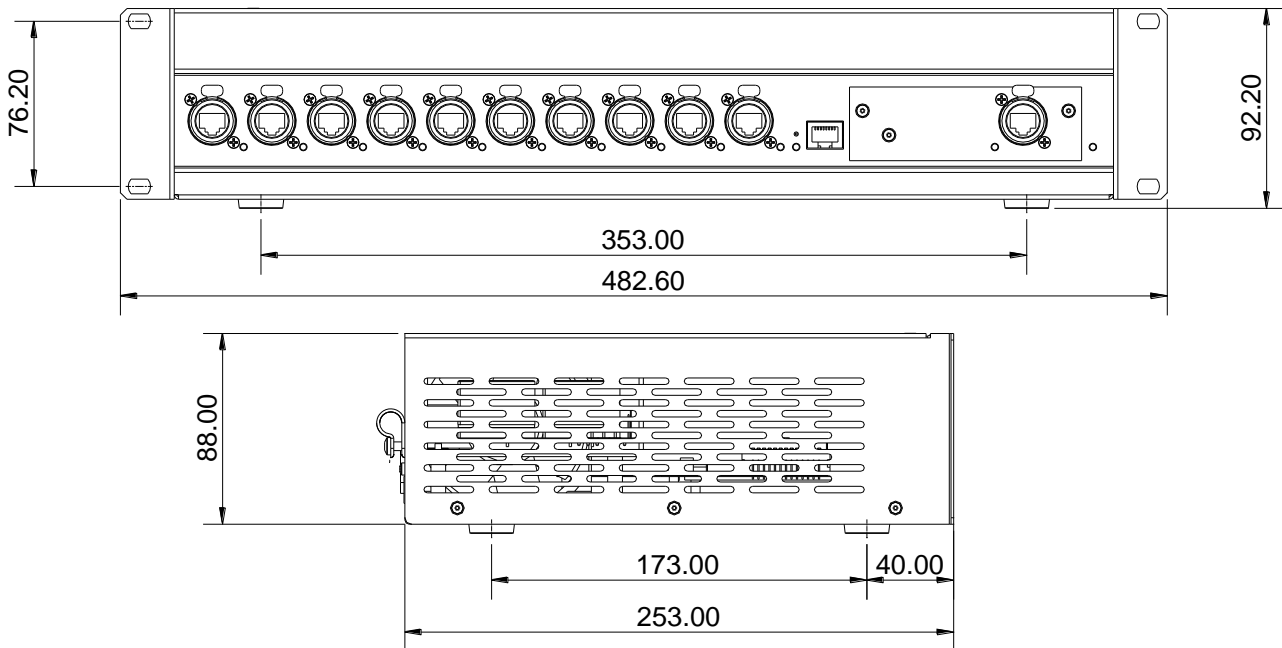

### 9.2 Specification

**Input** – Card option slot – 40 channels  
48kHz digital audio  
ME-D (dSNAKE, ACE, Aviom®) card provided  
Aviom® A-Net16 compatible -16 channels  
M-Dante network card option available  
M-MADI card option available  
M-Waves V2 network card option available  
M-ES-V2 EtherSound card option available

**Outputs** – 10 ports  
Compatible with ME mixers  
Locking EtherCon connectors  
PoE available on all output ports  
**Network Port** – Ethernet TCP/IP  
System setup + receiving iLive channel data

**Setup** – Uses PC or Mac web browser  
Received or manual channel names  
Received or manual odd/even stereo links  
iLive mode for receiving iLive names/links

**Default IP address** = 192.168.1.40  
Subnet Mask = 255.255.255.0  
Default Gateway = 192.168.1.254

**Mains Input** – 100-240V AC 47-63Hz 250W

**PoE capability** – 15W at each ME-U output

**Dimensions** – Width x Depth x Height  
2U rack - 483 x 253 x 92mm (19"x10"x3.6")

**Weight** – 4.6kg (10.1lbs) unpacked

### 9.3 Further information

Visit the Allen & Heath web site to find out more about the ME Personal Mixer System.

[www.allen-heath.com](http://www.allen-heath.com)

- ME-U application examples
- The ME System knowledgebase
- The latest ME-U operating firmware
- The latest ME-1 and ME-500 mixer firmware
- Allen & Heath contact for your territory